

WIDE BAND VHF/UHF AMPLIFIER

- SILICON PLANAR EPITAXIAL TRANSISTORS
- TO-72 METAL CASE
- VERY LOW NOISE

APPLICATIONS :

- TELECOMMUNICATIONS
- WIDE BAND UHF AMPLIFIER
- RADIO COMMUNICATIONS

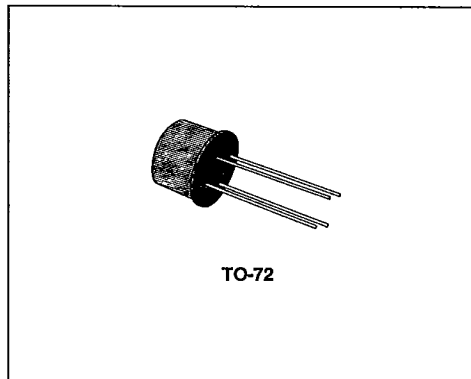

INTERNAL SCHEMATIC DIAGRAM

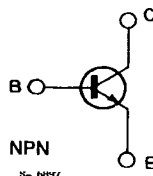

DESCRIPTION

The BFX89 and BFY90 are silicon planar epitaxial NPN transistors produced using interdigitated base emitter geometry. They are particularly designed for use in wide band common-emitter linear amplifiers up to 1 GHz. They feature very high f_T , low reverse capacitance, excellent cross modulation properties and very low noise performance. The BFY90 is complementary to the BFR99A. Typical applications include telecommunication and radio communication equipment.

ABSOLUTE MAXIMUM RATINGS

Symbol	Parameter	Value	Unit
V_{CBO}	Collector-base Voltage ($I_E = 0$)	30	V
V_{CER}	Collector-emitter Voltage ($R_{BE} \leq 50 \Omega$)	30	V
V_{CEO}	Collector-emitter Voltage ($I_B = 0$)	15	V
V_{EBO}	Emitter-base Voltage ($I_C = 0$)	2.5	V
I_C	Collector Current	25	mA
I_{CM}	Collector Peak Current ($f \geq 1$ MHz)	50	mA
P_{tot}	Total Power Dissipation at $T_{amb} \leq 25^\circ C$	200	mW
T_{stg}, T_j	Storage and Junction Temperature	- 65 to 200	$^\circ C$

30E D **7929237 0030996 1**

THERMAL DATA

$R_{th\ j-case}$	Thermal Resistance Junction-case	Max	580	°C/W
$R_{th\ j-amb}$	Thermal Resistance Junction-ambient	Max	880	°C/W

ELECTRICAL CHARACTERISTICS ($T_{amb} = 25\ ^\circ C$ unless otherwise specified)

Symbol	Parameter	Test Conditions	Min.	Typ.	Max.	Unit
I_{CBO}	Collector Cutoff Current ($I_E = 0$)	$V_{CB} = 15\ V$			10	nA
V_{CEK}^*	Collector-emitter Knee Voltage	$I_C = 20\ mA$			0.75	V
h_{FE}	DC Current Gain	$I_C = 2\ mA$ $V_{CE} = 1\ V$ for BFX89 25 for BFY90 $I_C = 25\ mA$ $V_{CE} = 1\ V$ 20	20 25 20		150 150 125	
f_T	Transition Frequency	$V_{CE} = 5\ V$ $f = 500\ MHz$ $I_C = 2\ mA$ for BFX89 for BFY90 $I_C = 25\ mA$ for BFX89 for BFY90	1 1.3	1 1.1 1.2 1.4		GHz GHz GHz GHz
$C_{CBO}^{(1)}$	Collector-base Capacitance	$I_E = 0$ $V_{CB} = 10\ V$ $f = 1\ MHz$ for BFX89 for BFY90			1.7 1.5	pF pF
$C_{re}^{(2)}$	Reverse Capacitance	$I_C = 2\ mA$ $V_{CE} = 5\ V$ $f = 1\ MHz$ for BFX89 for BFY90		0.6 0.6	0.8	pF pF
$NF^{(2)}$	Noise Figure	$I_C = 2\ mA$ $V_{CE} = 5\ V$ $R_g = \text{Optimized}$ $f = 100\ kHz$ for BFY90 Only $f = 200\ MHz$ $R_g = \text{Optimized}$ for BFX89 for BFY90 $f = 500\ MHz$ $R_g = 50\ \Omega$ for BFX89 for BFY90 $f = 800\ MHz$ $R_g = \text{Optimized}$ for BFX89 for BFY90 $f = 800\ MHz$			4 4 3.5 6.5 5	dB dB dB dB dB
$G_{pe}^{(2)}$	Power Gain (not neutralized)	for BFX89 $I_C = 8\ mA$ $V_{CE} = 10\ V$ $f = 200\ MHz$ $f = 800\ MHz$ for BFY90 $I_C = 14\ mA$ $V_{CE} = 10\ V$ $f = 200\ MHz$ $f = 800\ MHz$	19 21	22 7 23 8		dB dB dB dB

* I_B = value for which $I_C = 22\ mA$ at $V_{CE} = 1\ V$

(1) Shield lead not grounded

(2) Shield lead grounded

(3) $f_p = 202\ MHz$, $f_q = 205\ MHz$, $f_{(2q,p)} = 208\ MHz$

(4) $f_p = 798\ MHz$, $f_q = 802\ MHz$, $f_{(2q,p)} = 806\ MHz$

SGS-THOMSON

T-31-15

ELECTRICAL CHARACTERISTICS (continued)

Symbol	Parameter	Test Conditions	Min.	Typ.	Max.	Unit
P _o	Output Power	for BFX89 I _C = 8 mA V _{CE} = 10 V d _m = -30 dB (3) Channel 9 (4) Channel 62		6		mW
		for BFY90 I _C = 14 mA V _{CE} = 10 V d _m = -30 dB (3) Channel 9 (4) Channel 62	10	12	12	mW

* I_b = value for which I_C = 22 mA at V_{CE} = 1 V

- (1) Shield lead not grounded
- (2) Shield lead grounded

- (3) f_p = 202 MHz, f_q = 205 MHz, f_{2qP} = 208 MHz
- (4) f_p = 798 MHz, f_q = 802 MHz, f_{2qP} = 806 MHz

Power Rating Chart.

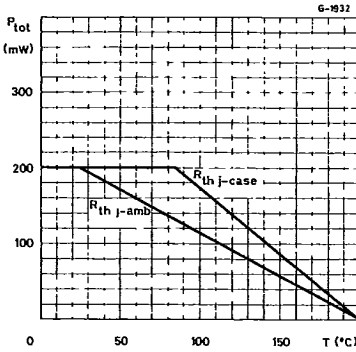

Transition Frequency.

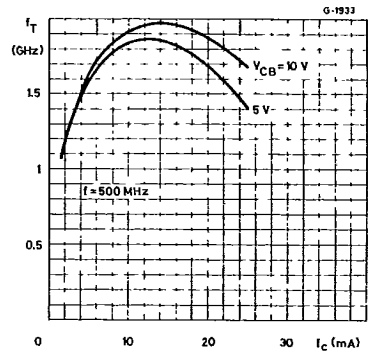

Collector-base Capacitance.

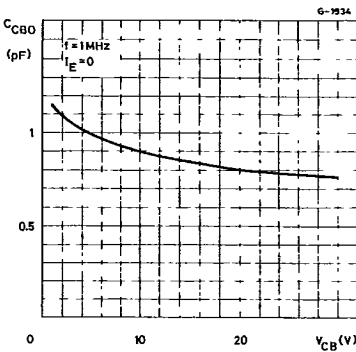

Noise Figure vs. Collector Current.

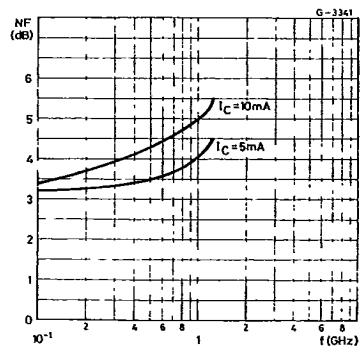

Noise Figure vs. Frequency.

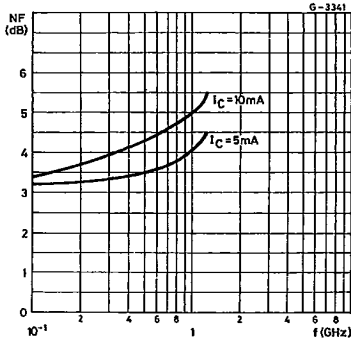

Forward Transmission Gain vs. Frequency.

