

BGA2717

MMIC wideband amplifier

Rev. 02 — 24 September 2004

Product data sheet

1. Product profile

1.1 General description

Silicon Monolithic Microwave Integrated Circuit (MMIC) wideband amplifier with internal matching circuit in a 6-pin SOT363 SMD plastic package.

CAUTION



This device is sensitive to electrostatic discharge (ESD). Therefore care should be taken during transport and handling.

1.2 Features

- Internally matched to 50 Ω
- Wide frequency range (3.2 GHz at 3 dB bandwidth)
- Flat 24 dB gain (± 1 dB up to 2.8 GHz)
- -2.5 dBm output power at 1 dB compression point
- Good linearity for low current ($IP_{3out} = 10$ dBm)
- Low second harmonic; -38 dBc at $P_D = -40$ dBm
- Low noise figure; 2.3 dB at 1 GHz
- Unconditionally stable ($K \geq 2$).

1.3 Applications

- LNB IF amplifiers
- Cable systems
- ISM
- General purpose.

1.4 Quick reference data

Table 1: Quick reference data

Symbol	Parameter	Conditions	Min	Typ	Max	Unit
V_S	DC supply voltage		-	5	6	V
I_S	supply current		-	8	-	mA
$ S_{21} ^2$	insertion power gain	$f = 1$ GHz	-	24	-	dB
NF	noise figure	$f = 1$ GHz	-	2.3	-	dB
$P_{L(sat)}$	saturated load power	$f = 1$ GHz	-	1	-	dBm

PHILIPS

2. Pinning information

Table 2: Pinning

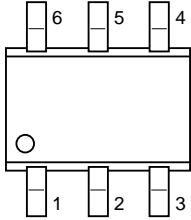
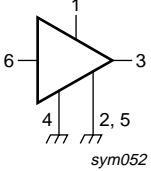
Pin	Description	Simplified outline	Symbol
1	V _S	 <p style="text-align: center;">SOT363</p>	 <p style="text-align: center;">sym052</p>
2, 5	GND2		
3	RF_OUT		
4	GND1		
6	RF_IN		

3. Ordering information

Table 3: Ordering information

Type number	Package		
	Name	Description	Version
BGA2717	-	plastic surface mounted package; 6 leads	SOT363

4. Marking

Table 4: Marking

Type number	Marking code
BGA2717	1B-

5. Limiting values

Table 5: Limiting values

In accordance with the Absolute Maximum Rating System (IEC 60134).

Symbol	Parameter	Conditions	Min	Max	Unit
V _S	DC supply voltage	RF input AC coupled	-	6	V
I _S	supply current		-	15	mA
P _{tot}	total power dissipation	T _{sp} ≤ 90 °C	-	200	mW
T _{stg}	storage temperature		-65	+150	°C
T _j	junction temperature		-	150	°C
P _D	maximum drive power		-	-10	dBm

6. Thermal characteristics

Table 6: Thermal characteristics

Symbol	Parameter	Conditions	Typ	Unit
$R_{th(j-sp)}$	thermal resistance from junction to solder point	$P_{tot} = 200 \text{ mW};$ $T_{sp} \leq 90 \text{ }^\circ\text{C}$	300	K/W

7. Characteristics

Table 7: Characteristics

$V_S = 5 \text{ V}; I_S = 8 \text{ mA}; T_j = 25 \text{ }^\circ\text{C};$ measured on demo board; unless otherwise specified.

Symbol	Parameter	Conditions	Min	Typ	Max	Unit
I_S	supply current		6	8	10	mA
$ s_{21} ^2$	insertion power gain	f = 100 MHz	18	18.6	20	dB
		f = 1 GHz	23	23.9	25	dB
		f = 1.8 GHz	24	25	27	dB
		f = 2.2 GHz	24	25.1	27	dB
		f = 2.6 GHz	22	24	26	dB
		f = 3 GHz	20	22.1	24	dB
$ s_{11} ^2$	input return losses	f = 1 GHz	15	19	-	dB
		f = 2.2 GHz	8	9.4	-	dB
$ s_{22} ^2$	output return losses	f = 1 GHz	8	10	-	dB
		f = 2.2 GHz	5	6.8	-	dB
$ s_{12} ^2$	isolation	f = 1.6 GHz	54	55	-	dB
		f = 2.2 GHz	38	39	-	dB
NF	noise figure	f = 1 GHz	-	2.3	2.5	dB
		f = 2.2 GHz	-	2.9	3.1	dB
B	bandwidth	at $ s_{21} ^2 - 3 \text{ dB}$ below flat gain at 1 GHz	3	3.2	-	GHz
K	stability factor	f = 1 GHz	-	13	-	
		f = 2.2 GHz	-	1.7	-	
$P_{L(sat)}$	saturated load power	f = 1 GHz	0	1.4	-	dBm
		f = 2.2 GHz	-1	+0.1	-	dBm
$P_{L(1dB)}$	load power	at 1 dB gain compression; f = 1 GHz	-4	-2.6	-	dBm
		at 1 dB gain compression; f = 2.2 GHz	-5	-3.1	-	dBm
IM2	second order intermodulation product	at $P_D = -40 \text{ dBm};$ $f_0 = 1 \text{ GHz}$	36	38	-	dBc
IP3 _{in}	input, third order intercept point	f = 1 GHz	-15	-13.9	-	dBm
		f = 2.2 GHz	-20	-18.8	-	dBm
IP3 _{out}	output, third order intercept point	f = 1 GHz	9	10	-	dBm
		f = 2.2 GHz	4	6.3	-	dBm

8. Application information

[Figure 1](#) shows a typical application circuit for the BGA2717 MMIC. The device is internally matched to $50\ \Omega$, and therefore does not need any external matching. The value of the input and output DC blocking capacitors C2 and C3 should not be more than 100 pF for applications above 100 MHz. However, when the device is operated below 100 MHz, the capacitor value should be increased.

The 22 nF supply decoupling capacitor C1 should be located as close as possible to the MMIC.

The printed-circuit board (PCB) top ground plane, connected to pins 2, 4 and 5 must be as close as possible to the MMIC, and ideally directly beneath it. When using via holes, use multiple via holes, located as close as possible to the MMIC.

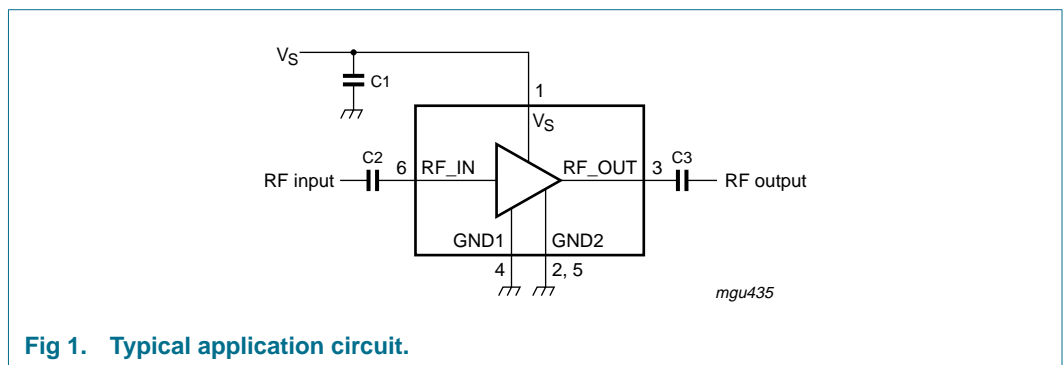
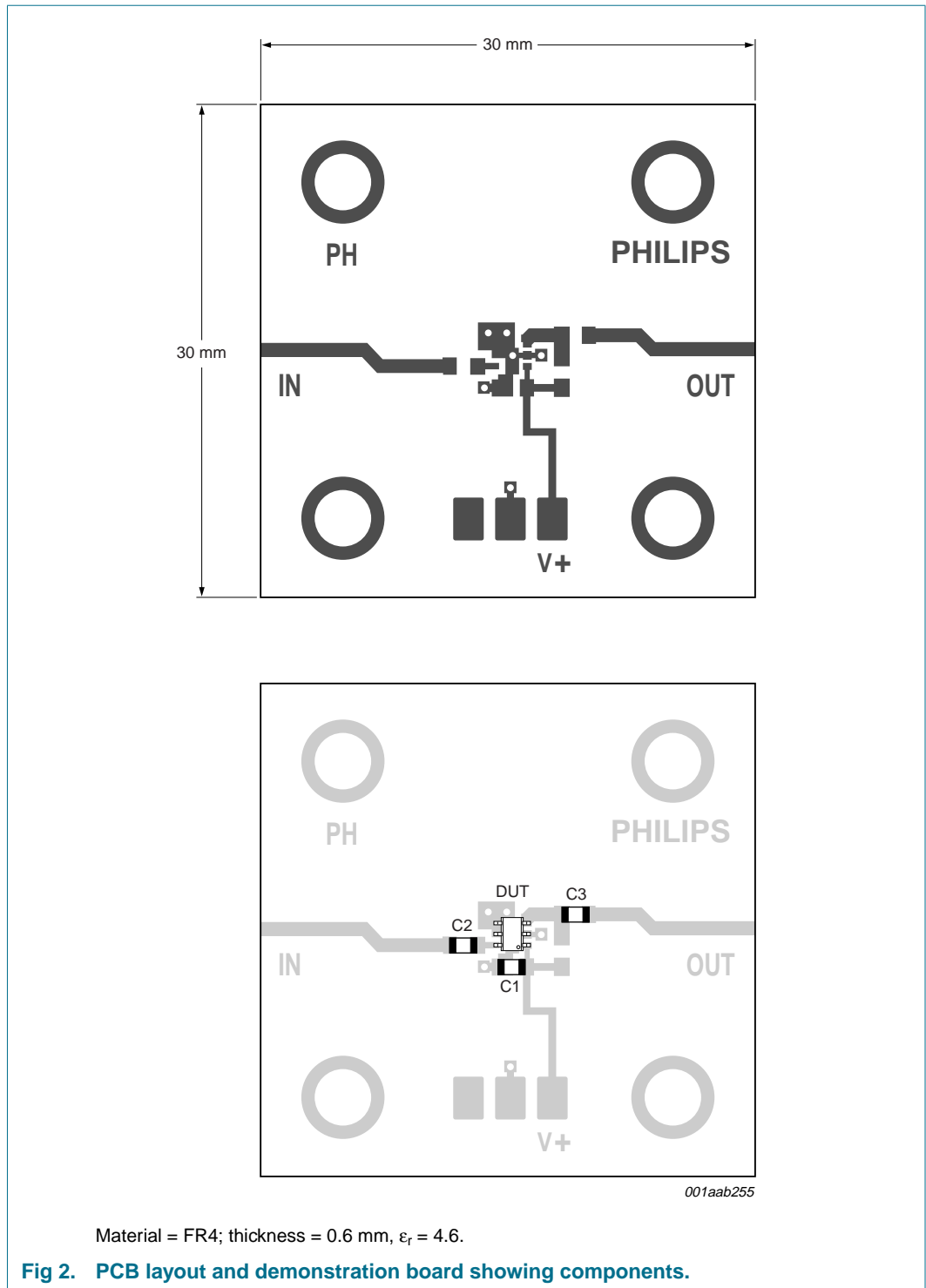

Fig 1. Typical application circuit.

[Figure 2](#) shows the PCB layout, used for the standard demonstration board.



8.1 Grounding and output impedance

If the grounding is not optimal, the gain becomes less flat and the 50 Ω output matching becomes worse. If a better output matching to 50 Ω is required, a 12 Ω resistor (R1) can be placed in series with C3 (see [Figure 3](#)). This will significantly improve the output impedance, at the cost of 1 dB gain and 1 dB output power.

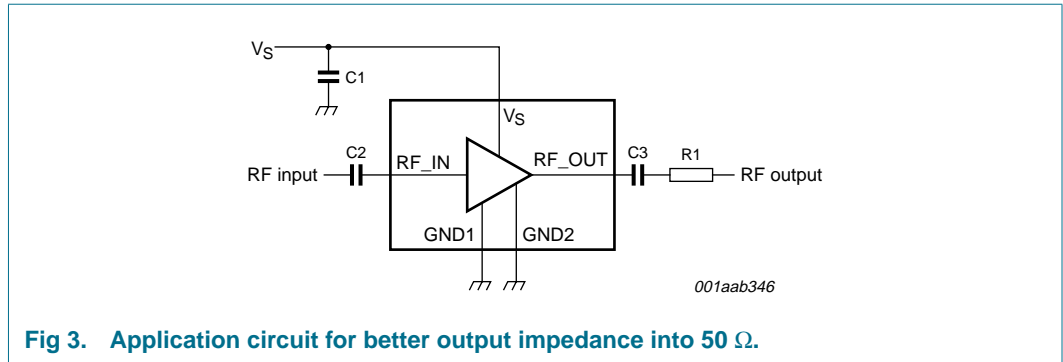

8.2 Application examples

The MMIC is very suitable as IF amplifier in e.g. LNBS. The excellent wideband characteristics make it an ideal building block (see [Figure 4](#)). As second amplifier after an LNA, the MMIC offers an easy matching, low noise solution (see [Figure 5](#)).

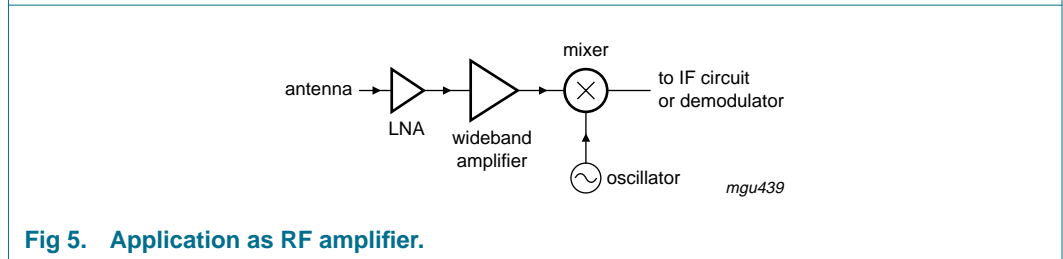
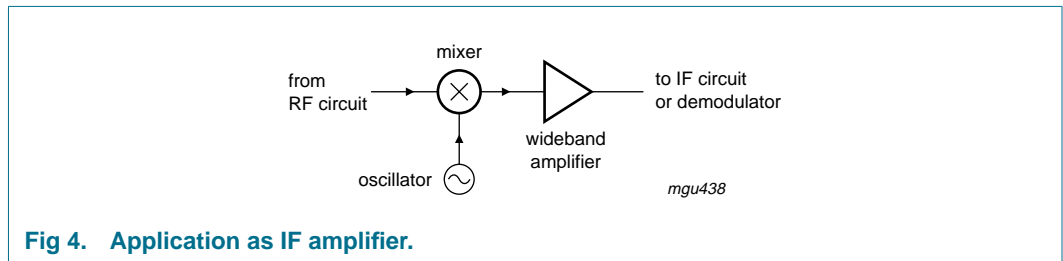

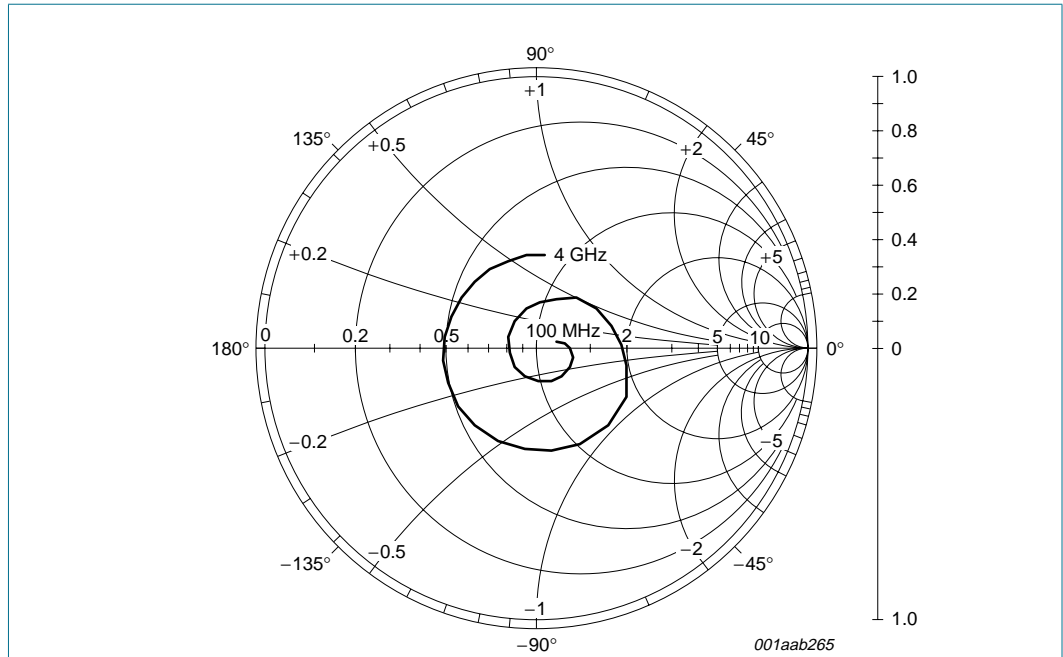

$I_S = 8 \text{ mA}$; $V_S = 5 \text{ V}$; $P_D = -35 \text{ dBm}$; $Z_o = 50 \Omega$.

Fig 6. Input reflection coefficient (s_{11}); typical values.

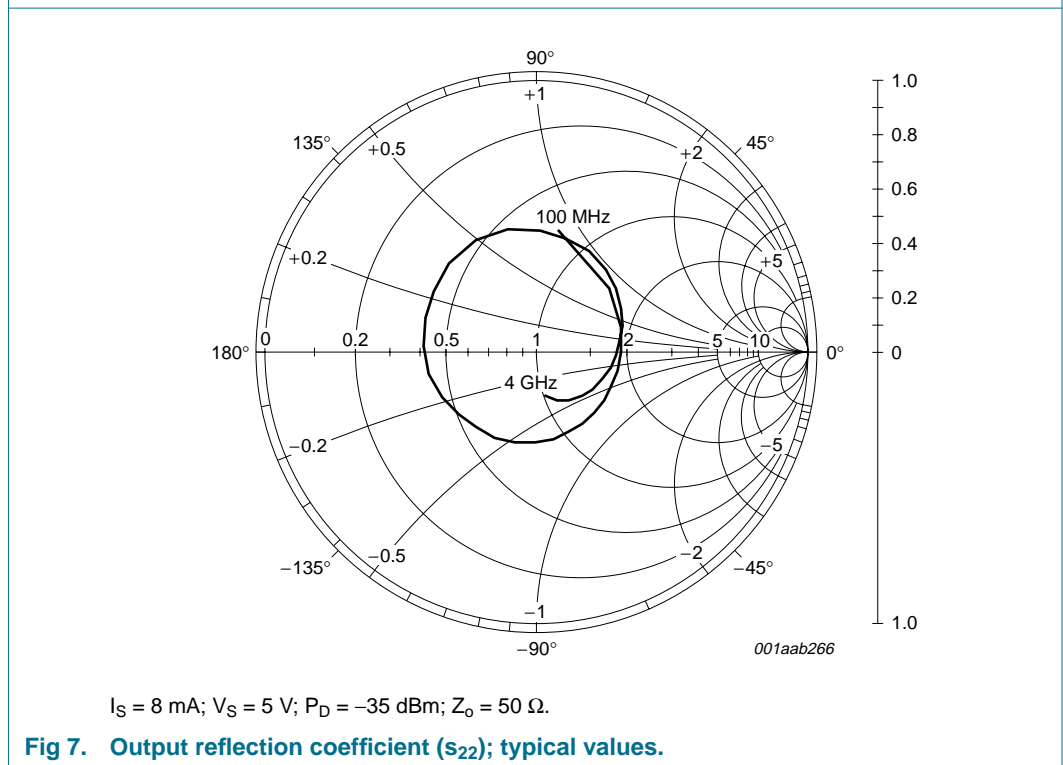

$I_S = 8 \text{ mA}$; $V_S = 5 \text{ V}$; $P_D = -35 \text{ dBm}$; $Z_o = 50 \Omega$.

Fig 7. Output reflection coefficient (s_{22}); typical values.

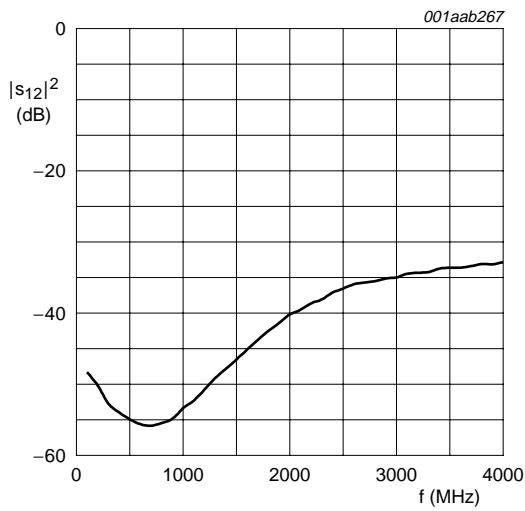

$I_S = 8 \text{ mA}$; $V_S = 5 \text{ V}$; $P_D = -35 \text{ dBm}$; $Z_o = 50 \Omega$.

Fig 8. Isolation ($|S_{12}|^2$) as a function of frequency; typical values.

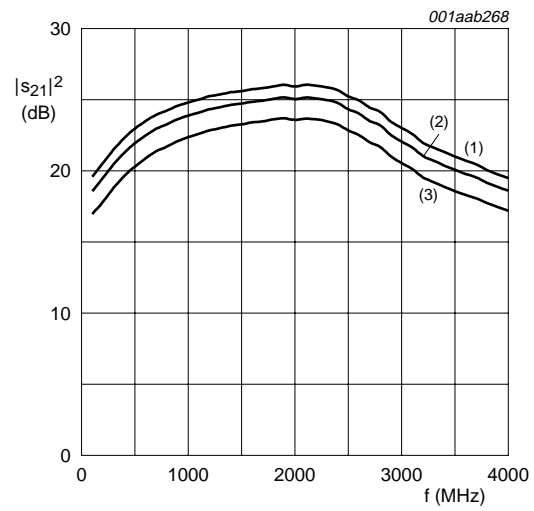

$P_D = -35 \text{ dBm}$; $Z_o = 50 \Omega$.

- (1) $I_S = 8.9 \text{ mA}$; $V_S = 5.5 \text{ V}$.
- (2) $I_S = 8 \text{ mA}$; $V_S = 5 \text{ V}$.
- (3) $I_S = 7.2 \text{ mA}$; $V_S = 4.5 \text{ V}$.

Fig 9. Insertion gain ($|S_{21}|^2$) as a function of frequency; typical values.

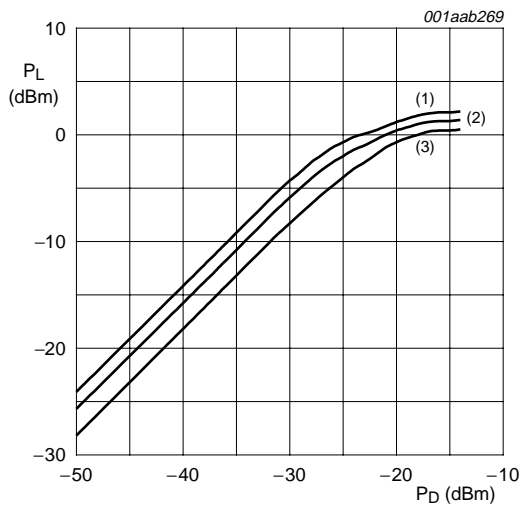

$f = 1 \text{ GHz}$; $Z_o = 50 \Omega$.

- (1) $V_S = 5.5 \text{ V}$.
- (2) $V_S = 5 \text{ V}$.
- (3) $V_S = 4.5 \text{ V}$.

Fig 10. Load power as a function of drive power at 1 GHz; typical values.

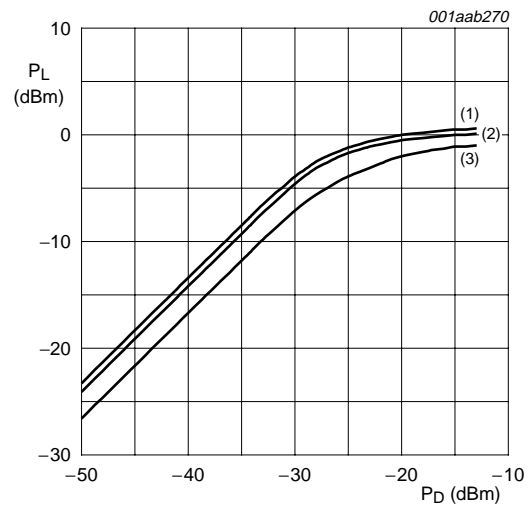

$f = 2.2 \text{ GHz}$; $Z_o = 50 \Omega$.

- (1) $V_S = 5.5 \text{ V}$.
- (2) $V_S = 5 \text{ V}$.
- (3) $V_S = 4.5 \text{ V}$.

Fig 11. Load power as a function of drive power at 2.2 GHz; typical values.

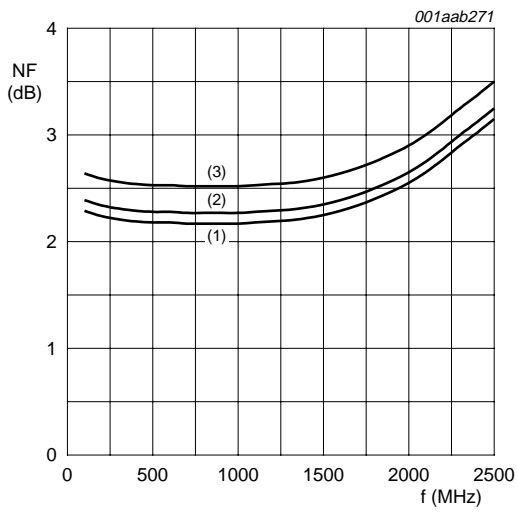

- $Z_o = 50 \Omega$.
- (1) $I_S = 8.9 \text{ mA}$; $V_S = 5.5 \text{ V}$.
 - (2) $I_S = 8 \text{ mA}$; $V_S = 5 \text{ V}$.
 - (3) $I_S = 7.2 \text{ mA}$; $V_S = 4.5 \text{ V}$.

Fig 12. Noise figure as a function of frequency; typical values.

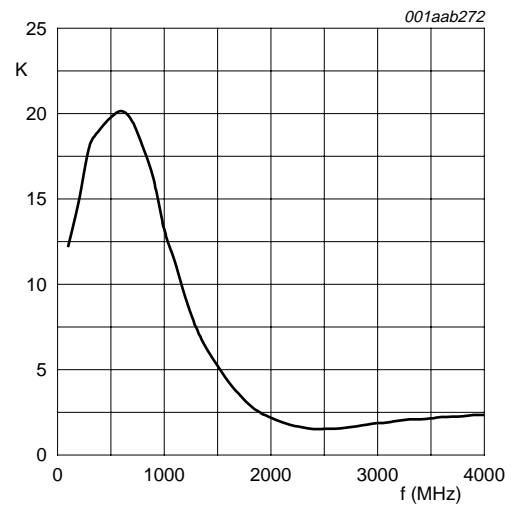

$I_S = 8 \text{ mA}$; $V_S = 5 \text{ V}$; $Z_o = 50 \Omega$.

Fig 13. Stability factor as a function of frequency; typical values.

Table 8: Scattering parameters $V_S = 5\text{ V}$; $I_S = 8\text{ mA}$; $P_D = -35\text{ dBm}$; $Z_o = 50\ \Omega$; $T_{amb} = 25\text{ }^\circ\text{C}$.

f (MHz)	S ₁₁		S ₂₁		S ₁₂		S ₂₂		K-factor
	Magnitude (ratio)	Angle (deg)	Magnitude (ratio)	Angle (deg)	Magnitude (ratio)	Angle (deg)	Magnitude (ratio)	Angle (deg)	
100	0.074378	13.78537	8.465495	22.90763	0.003859	-66.39435	0.450496	79.88713	12.2
200	0.076338	13.70153	9.420359	7.358555	0.003112	-122.2687	0.354179	40.70919	14.9
400	0.123748	-1.402521	11.56481	-14.92222	0.002011	-40.5142	0.312568	-0.3804	19.1
600	0.145511	-31.32646	13.31271	-37.77988	0.001659	-156.393	0.3038	-25.36808	20.2
800	0.134956	-67.10955	14.56872	-61.08808	0.00169	-164.4454	0.30873	-46.7704	18.1
1000	0.114063	-111.2495	15.61733	-84.67015	0.002146	-174.8593	0.319208	-68.71787	13.2
1200	0.101959	-168.8557	16.45625	-107.9167	0.002901	139.8136	0.335623	-91.58398	9.2
1400	0.125656	129.9717	17.05668	-131.63	0.004053	123.527	0.353582	-116.5485	6.2
1600	0.16736	85.791	17.49643	-155.2301	0.005545	107.0763	0.366893	-140.7537	4.3
1800	0.234721	51.43065	17.90167	-179.6656	0.007498	105.9423	0.404064	-167.9683	2.9
2000	0.285944	16.46701	17.86635	155.5993	0.009779	90.10168	0.42512	163.3173	2.2
2200	0.339673	-11.74152	17.96498	130.5601	0.011736	75.19814	0.459194	135.039	1.7
2400	0.393746	-47.58817	17.32414	103.3297	0.013927	53.10814	0.459988	103.1106	1.5
2600	0.384353	-81.55786	15.87927	77.84766	0.015937	21.70136	0.428158	75.83004	1.5
2800	0.376183	-112.353	14.44081	52.77053	0.016795	4.656224	0.393701	50.16202	1.7
3000	0.358586	-142.5801	12.67831	30.51455	0.01786	-19.19006	0.3497	26.66791	1.9
3200	0.345562	-171.7261	11.27597	10.04765	0.019217	-32.22469	0.30875	6.504047	2.0
3400	0.33312	160.2254	10.43483	-9.842264	0.020551	-49.16136	0.279672	-12.63121	2.1
3600	0.331268	133.8644	9.743293	-30.36495	0.020908	-59.65434	0.248479	-33.64811	2.2
3800	0.337502	108.48	9.072149	-50.7401	0.022136	-78.78085	0.21362	-56.42401	2.3
4000	0.344645	84.75183	8.513716	-71.86536	0.022792	-94.87525	0.168643	-80.24833	2.4

9. Package outline

Plastic surface mounted package; 6 leads

SOT363

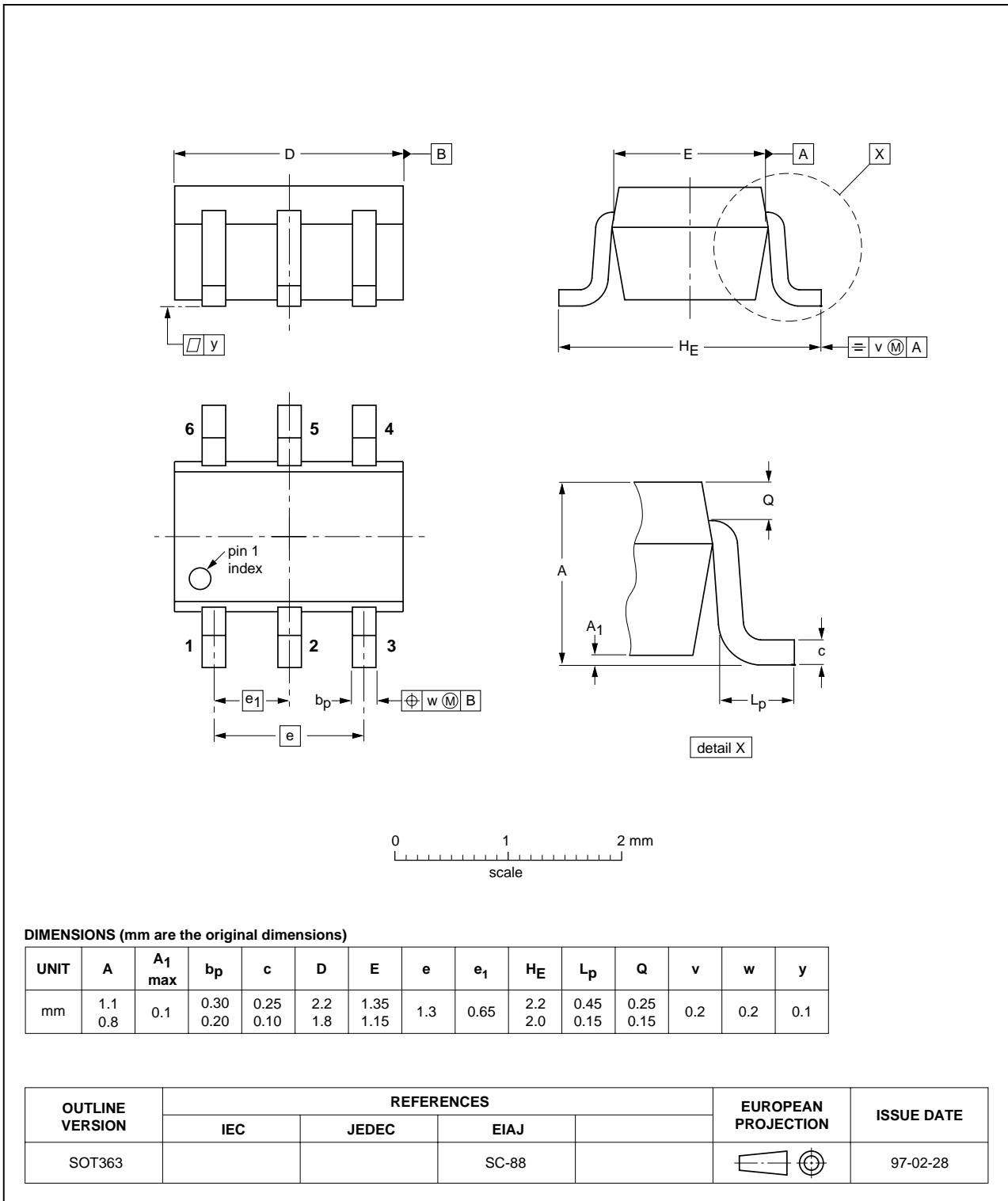

Fig 14. Package outline; SOT363 (SC-88).

10. Revision history

Table 9: Revision history

Document ID	Release date	Data sheet status	Change notice	Doc. number	Supersedes
BGA2717_2	20040924	Product data sheet	-	9397 750 13293	BGA2717_N_1
Modifications:	<ul style="list-style-type: none">The format of this data sheet has been redesigned to comply with the new presentation and information standard of Philips Semiconductors				
BGA2717_N_1	20040202	Preliminary data sheet	-	9397 750 12828	-

11. Data sheet status

Level	Data sheet status ^[1]	Product status ^[2] ^[3]	Definition
I	Objective data	Development	This data sheet contains data from the objective specification for product development. Philips Semiconductors reserves the right to change the specification in any manner without notice.
II	Preliminary data	Qualification	This data sheet contains data from the preliminary specification. Supplementary data will be published at a later date. Philips Semiconductors reserves the right to change the specification without notice, in order to improve the design and supply the best possible product.
III	Product data	Production	This data sheet contains data from the product specification. Philips Semiconductors reserves the right to make changes at any time in order to improve the design, manufacturing and supply. Relevant changes will be communicated via a Customer Product/Process Change Notification (CPCN).

[1] Please consult the most recently issued data sheet before initiating or completing a design.

[2] The product status of the device(s) described in this data sheet may have changed since this data sheet was published. The latest information is available on the Internet at URL <http://www.semiconductors.philips.com>.

[3] For data sheets describing multiple type numbers, the highest-level product status determines the data sheet status.

12. Definitions

Short-form specification — The data in a short-form specification is extracted from a full data sheet with the same type number and title. For detailed information see the relevant data sheet or data handbook.

Limiting values definition — Limiting values given are in accordance with the Absolute Maximum Rating System (IEC 60134). Stress above one or more of the limiting values may cause permanent damage to the device. These are stress ratings only and operation of the device at these or at any other conditions above those given in the Characteristics sections of the specification is not implied. Exposure to limiting values for extended periods may affect device reliability.

Application information — Applications that are described herein for any of these products are for illustrative purposes only. Philips Semiconductors make no representation or warranty that such applications will be suitable for the specified use without further testing or modification.

13. Disclaimers

Life support — These products are not designed for use in life support appliances, devices, or systems where malfunction of these products can reasonably be expected to result in personal injury. Philips Semiconductors customers using or selling these products for use in such applications do so at their own risk and agree to fully indemnify Philips Semiconductors for any damages resulting from such application.

Right to make changes — Philips Semiconductors reserves the right to make changes in the products - including circuits, standard cells, and/or software - described or contained herein in order to improve design and/or performance. When the product is in full production (status 'Production'), relevant changes will be communicated via a Customer Product/Process Change Notification (CPCN). Philips Semiconductors assumes no responsibility or liability for the use of any of these products, conveys no license or title under any patent, copyright, or mask work right to these products, and makes no representations or warranties that these products are free from patent, copyright, or mask work right infringement, unless otherwise specified.

14. Contact information

For additional information, please visit: <http://www.semiconductors.philips.com>

For sales office addresses, send an email to: sales.addresses@www.semiconductors.philips.com

15. Contents

1	Product profile	1
1.1	General description	1
1.2	Features	1
1.3	Applications	1
1.4	Quick reference data	1
2	Pinning information	2
3	Ordering information	2
4	Marking	2
5	Limiting values	2
6	Thermal characteristics	3
7	Characteristics	3
8	Application information	4
8.1	Grounding and output impedance	5
8.2	Application examples	6
9	Package outline	11
10	Revision history	12
11	Data sheet status	13
12	Definitions	13
13	Disclaimers	13
14	Contact information	13



© Koninklijke Philips Electronics N.V. 2004

All rights are reserved. Reproduction in whole or in part is prohibited without the prior written consent of the copyright owner. The information presented in this document does not form part of any quotation or contract, is believed to be accurate and reliable and may be changed without notice. No liability will be accepted by the publisher for any consequence of its use. Publication thereof does not convey nor imply any license under patent- or other industrial or intellectual property rights.

Date of release: 24 September 2004
Document number: 9397 750 13293

Published in The Netherlands