

Silicon Switching Diode Array

- Bridge configuration
- High-speed switching diode chip

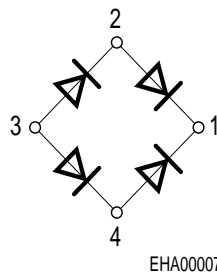
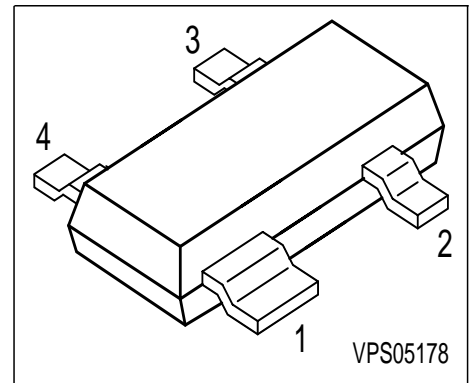

Type	Marking	Pin Configuration				Package
		1=C1/C2	2=A1/C4	3=A3/A4	4=A2/C3	
BGX50A	U1s	1=C1/C2	2=A1/C4	3=A3/A4	4=A2/C3	SOT143

Maximum Ratings

Parameter	Symbol	Value	Unit
Diode reverse voltage	V_R	50	V
Peak reverse voltage	V_{RM}	70	
Forward current	I_F	140	mA
Total power dissipation, $T_S = 74\text{ °C}$	P_{tot}	210	mW
Junction temperature	T_j	150	°C
Storage temperature	T_{stg}	65 ... 150	

Thermal Resistance

Junction - soldering point ¹⁾	R_{thJS}	≤ 360	K/W
--	------------	-------	-----

¹⁾For calculation of R_{thJA} please refer to Application Note Thermal Resistance

Electrical Characteristics at $T_A = 25^\circ\text{C}$, unless otherwise specified.

Parameter	Symbol	Values			Unit
		min.	typ.	max.	
DC characteristics					
Forward voltage $I_F = 100\text{ mA}$	V_F	-	-	1.3	V
Reverse current $V_R = 50\text{ V}$	I_R	-	-	0.2	μA
Reverse current $V_R = 50\text{ V}, T_A = 150^\circ\text{C}$	I_R	-	-	100	
AC characteristics					
Diode capacitance $V_R = 0\text{ V}, f = 1\text{ MHz}$	C_D	-	-	1.5	pF
Reverse recovery time $I_F = 10\text{ mA}, I_R = 10\text{ mA}, R_L = 100\ \Omega$, measured at $I_R = 1\text{ mA}$	t_{rr}	-	-	6	ns

Test circuit for reverse recovery time

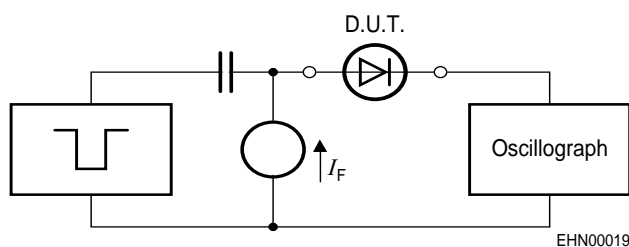

Pulse generator: $t_p = 100\text{ ns}$, $D = 0.05$,
 $t_r = 0.6\text{ ns}$, $R_i = 50\ \Omega$

Oscilloscope: $R = 50\ \Omega$, $t_r = 0.35\text{ ns}$,
 $C \leq 1\text{ pF}$

Forward current $I_F = f(T_S)$

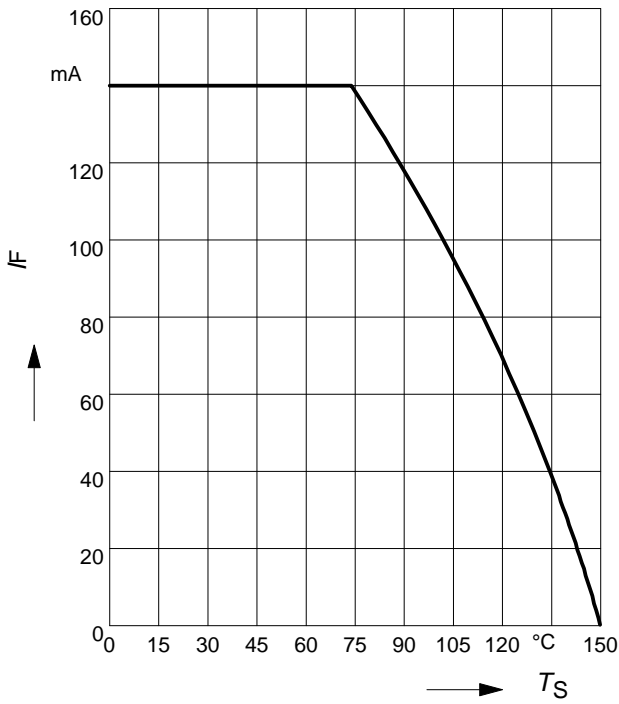

Reverse current $I_R = f(T_A)$

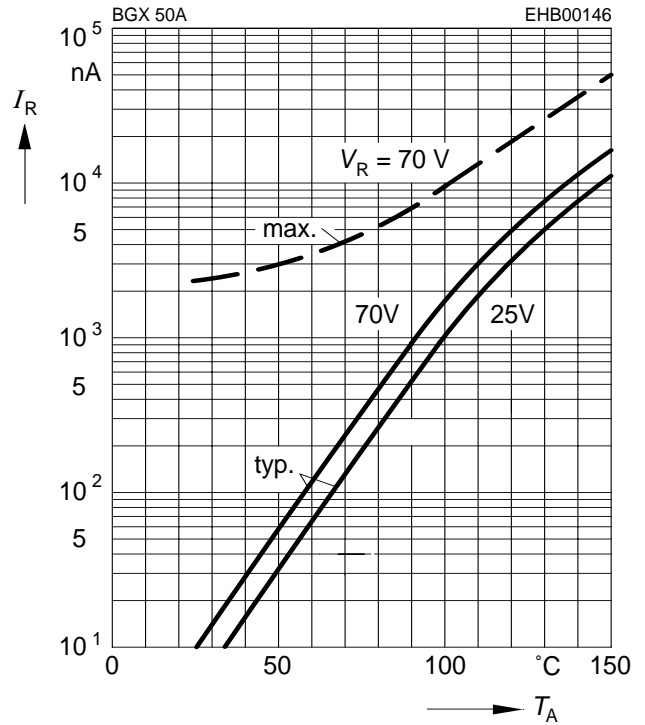

Forward current $I_F = f(V_F)$

$T_A = 25^\circ\text{C}$

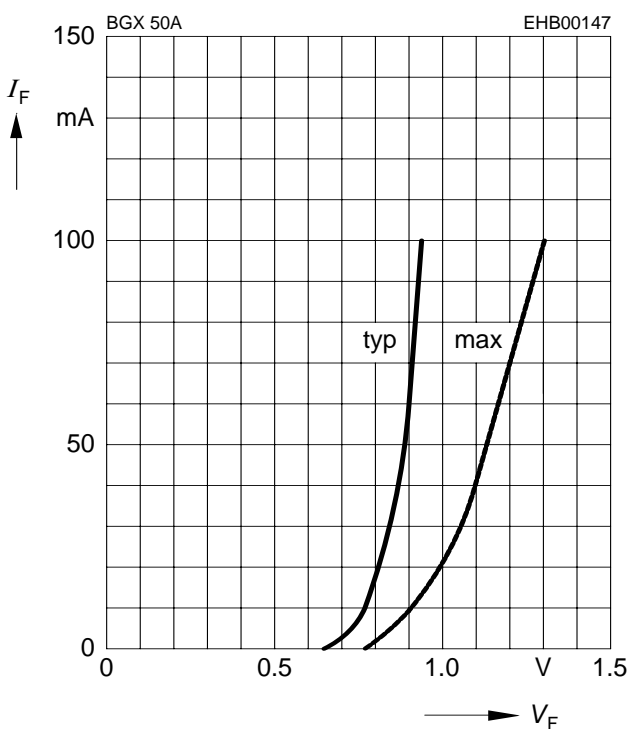

Peak forward current $I_{FM} = f(t_p)$

$T_A = 25^\circ\text{C}$

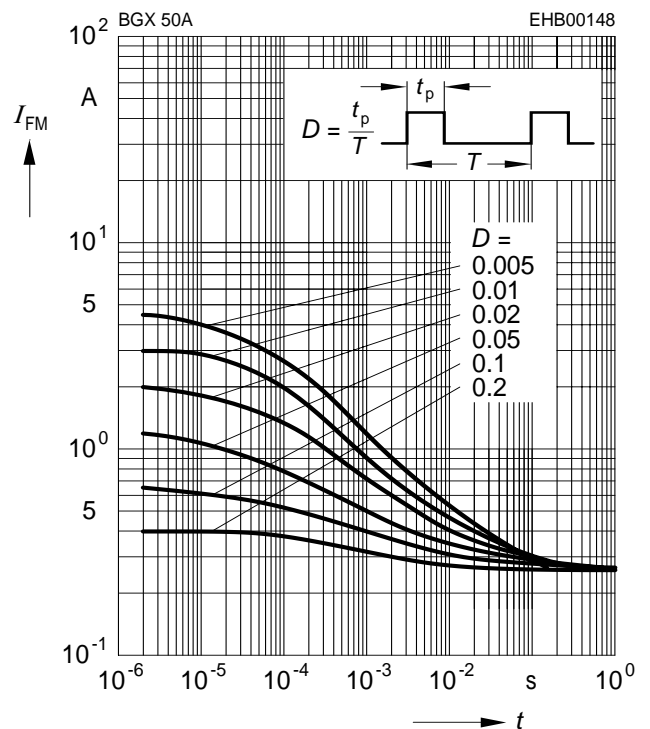

Forward voltage $V_F = f(T_A)$

