

# Ambient Light Sensor ICs

## 1 Chip Optical Proximity Sensor + Ambient Light Sensor IC

**BH1771GLC**

No.11046EBT11

### ●Descriptions

BH1771GLC is the IC into which optical proximity sensor and digital ambient light sensor are unified. Proximity sensor part detects the human or object approach by reflection of infrared LED(IrLED) light. And this device can drive maximum 3 IrLEDs, and touch-less motion detection function can be implemented. Ambient light part can detect the wide range illuminance from the dark up to under direct sun light. The illuminant intensity of LCD display and keypad can be adjusted, so lower current consumption or higher visibility are possible.

### ●Features

- 1) Correspond to I<sup>2</sup>C bus interface ( f/s mode & Hs mode support )
- 2) Low Current by power down function
- 3) Correspond to 1.8V logic interface
- 4) ALS spectral responsibility is approximately human eye response ( Peak wavelength : typ. 550nm )
- 5) Correspond to wide range of light intensity ( 1-65535 lx range )
- 6) Rejecting 50Hz/60Hz light noise (ALS function)
- 7) Detection range of proximity sensor is around 10 - 100mm (configurable by I<sup>2</sup>C bus)
- 8) Touch-less motion detection function
- 9) Built in ambient light cancelation (Proximity sensor function)
- 10) Built in configurable IrLED current driver

### ●Applications

Mobile phone, DSC, Portable game, Camcorder, Car navigation, PDA, LCD display etc.

### ●Absolute Maximum Ratings ( Ta = 25°C )

Parameter	Symbol	Ratings	Units
VCC, Supply Voltage	Vccmax	4.5	V
SDA,SCL,GNDNC Terminal Voltage	VSDAmax, VSCLmax, VGNDNCmax	4.5	V
LED1,LED2,LED3 INT Terminal Voltage	VLEDmax, VINTmax	7	V
Operating Temperature	Topr	-40~85	°C
Storage Temperature	Tstg	-40~100	°C
SDA, INT Sink Current	I <sub>max</sub>	7	mA
Power Dissipation	P <sub>d</sub>	250*	mW

\* 70mm × 70mm × 1.6mm glass epoxy board. Decreasing rate is 3.33mW/°C for operating above Ta=25°C

### ●Operating Conditions

Parameter	Symbol	Ratings			Units
		Min.	Typ.	Max.	
VCC Voltage	Vcc	2.3	2.5	3.6	V
LED1,LED2,LED3 Terminal Voltage	Vled	0.7	2.5	5.5	V

●Electrical characteristics ( VCC = 2.5V, Ta = 25°C, unless otherwise noted. )

Parameter	Symbol	Limits			Units	Conditions
		Min.	Typ.	Max.		
Supply current for ALS	Icc1	—	90	180	μA	Ev = 100 lx ※1 Average current when ALS_CONTROL register(40h) = "03h" and the other registers are default.
Supply current for PS	Icc2	—	90	180	μA	Average current when PS_CONTROL register(41h) = "03h" and the other registers are default.
Supply current for PS during driving LED current	Icc3	—	6.5	8.5	mA	
Standby mode current	Icc4	—	0.8	1.5	μA	ALS & PS standby No Input Light f/s mode
ALS measurement time	tMALS	—	100	125	ms	H-Resolution mode
ALS measurement accuracy	S/A	0.85	1.0	1.15	Times	Sensor out / Actual Ix, Ev = 1000 lx ※1
ALS dark ( 0 lx ) sensor out	ALS0	0	0	2	count	H-Resolution mode
PS sensor out (No proximity object)	PS0	0	0	9	count	Ambient irradiance = 0μW/cm <sup>2</sup>
PS sensor out ( Irradiance by proximity object = 324μW/cm <sup>2</sup> )	PS324u	120	128	136	count	Ambient irradiance = 0μW/cm <sup>2</sup>
ILED pulse duration	twILED	—	200	250	μs	
Cumulative ILED pulse duration	twILED2	—	1	1.25	ms	ILED register(42h) [7:6] = "11"
PS measurement time	tMPS	—	10	12.5	ms	
LED1 terminal sink current at LED1 terminal voltage = 1.3V	ILED1	18	20	22	mA	ILED register(42h) [2:0] = "010"
LED2 terminal sink current at LED2 terminal voltage = 1.3V	ILED2	18	20	22	mA	ILED register(42h) [5:3] = "010"
LED3 terminal sink current at LED3 terminal voltage = 1.3V	ILED3	18	20	22	mA	ILED3 register(43h) [2:0] = "010"
INT output 'L' Voltage	VINT	0	—	0.4	V	IINT = 3mA
SCL SDA input 'H' Voltage	VIH	1.26	—	—	V	
SCL SDA input 'L' Voltage	VIL	—	—	0.54	V	
SCL SDA input 'H'/'L' Current	IIHL	-10	—	10	μA	
I <sup>2</sup> C SDA output 'L' Voltage	VOL	0	—	0.4	V	IOL = 3mA

※1 White LED is used as optical source

● I<sup>2</sup>C bus timing characteristics ( VCC = 2.5V, Ta = 25°C, unless otherwise noted. )

Parameter	Symbol	Limits			Units	Conditions
		Min.	Typ.	Max.		
I <sup>2</sup> C SCL Clock Frequency	f <sub>SCL</sub>	0	—	400	kHz	f/s mode
I <sup>2</sup> C SCL Clock Frequency2	f <sub>SCLH</sub>	0	—	3.4	MHz	Hs mode Cb=100pF
I <sup>2</sup> C Hold Time ( Repeated ) START Condition	t <sub>HD;STA</sub>	0.6	—	—	μs	f/s mode
I <sup>2</sup> C Hold Time ( Repeated ) START Condition2	t <sub>HD;STA</sub>	160	—	—	ns	Hs mode
I <sup>2</sup> C 'L' Period of the SCL Clock	t <sub>LOW</sub>	1.3	—	—	μs	f/s mode
I <sup>2</sup> C 'L' Period of the SCL Clock2	t <sub>LOW</sub>	160	—	—	ns	Hs mode
I <sup>2</sup> C 'H' Period of the SCL Clock	t <sub>HIGH</sub>	0.6	—	—	μs	f/s mode
I <sup>2</sup> C 'H' Period of the SCL Clock2	t <sub>HIGH</sub>	60	—	—	ns	Hs mode
I <sup>2</sup> C Set up time for a Repeated START Condition	t <sub>SU;STA</sub>	0.6	—	—	μs	f/s mode
I <sup>2</sup> C Set up time for a Repeated START Condition2	t <sub>SU;STA</sub>	160	—	—	ns	Hs mode
I <sup>2</sup> C Data Hold Time	t <sub>HD;DAT</sub>	0	—	—	μs	f/s mode
I <sup>2</sup> C Data Hold Time2	t <sub>HD;DAT</sub>	0	—	70	ns	Hs mode Cb=100pF
I <sup>2</sup> C Data Setup Time	t <sub>SU;DAT</sub>	100	—	—	ns	f/s mode
I <sup>2</sup> C Data Setup Time2	t <sub>SU;DAT</sub>	10	—	—	ns	Hs mode
I <sup>2</sup> C Set up Time for STOP Condition	t <sub>SU;STO</sub>	0.6	—	—	μs	f/s mode
I <sup>2</sup> C Set up Time for STOP Condition2	t <sub>SU;STO</sub>	160	—	—	ns	Hs mode
I <sup>2</sup> C Bus Free Time between a STOP and START Condition	t <sub>BUF</sub>	1.3	—	—	μs	
I <sup>2</sup> C Data Valid Time	t <sub>VD;DAT</sub>	—	—	0.9	μs	f/s mode
I <sup>2</sup> C Data Valid Acknowledge Time	t <sub>VD;ACK</sub>	—	—	0.9	μs	f/s mode

● Package outlines

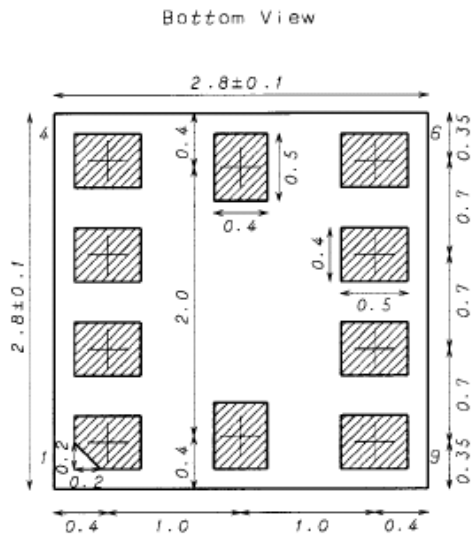
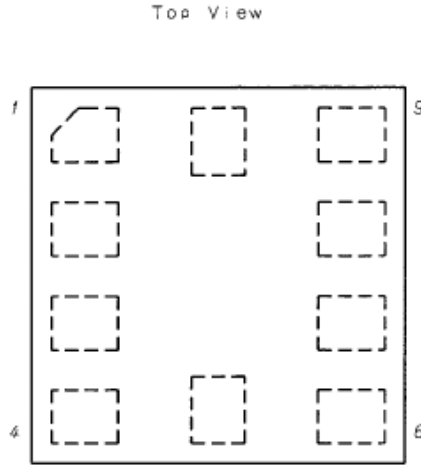
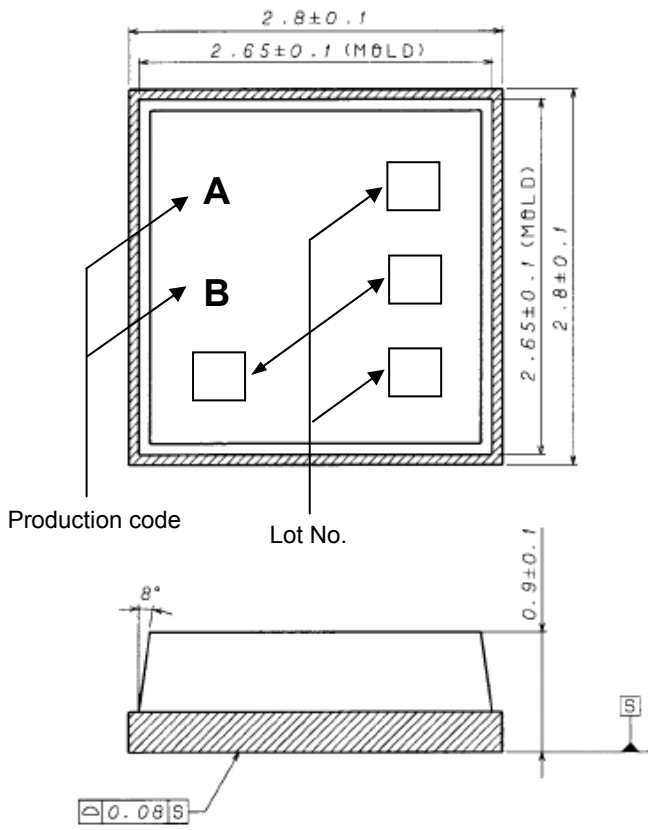

WLGA010V28

(UNIT:mm)

Drawing No. EX812-6001

●Reference Data

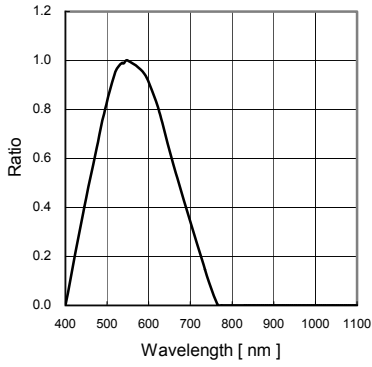

Fig.1 ALS Spectral Response

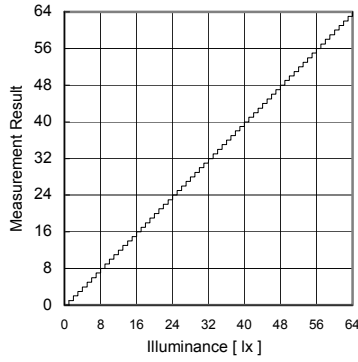

Fig.2 Illuminance - ALS Measurement Result

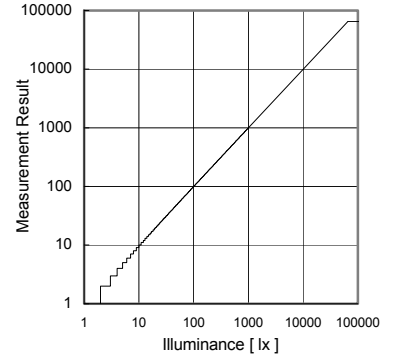

Fig.3 Illuminance - ALS Measurement Result 2

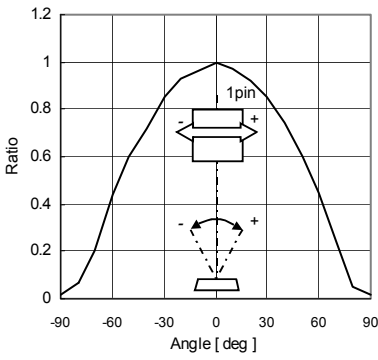

Fig.4 ALS Directional Characteristics 1

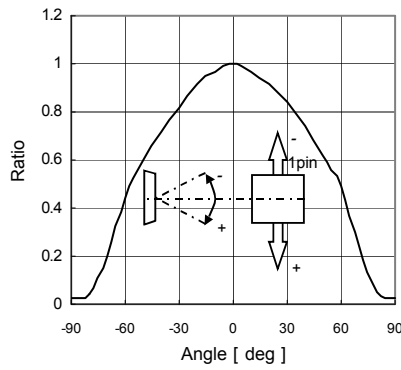

Fig.5 ALS Directional Characteristics 2

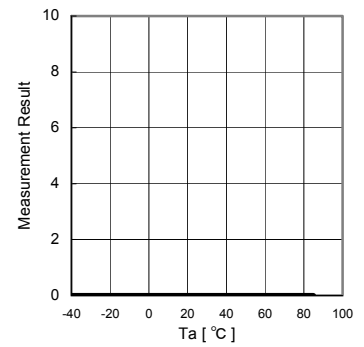

Fig.6 ALS Dark Response

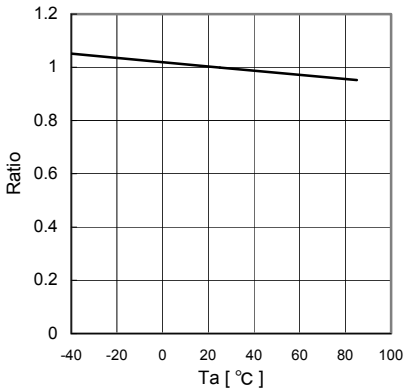

Fig.7 ALS Measurement Accuracy Temperature Dependency

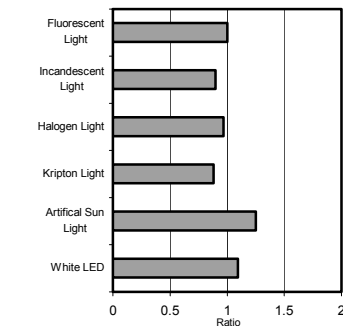

Fig.8 ALS Light Source Dependency (Fluorescent Light is set to '1')

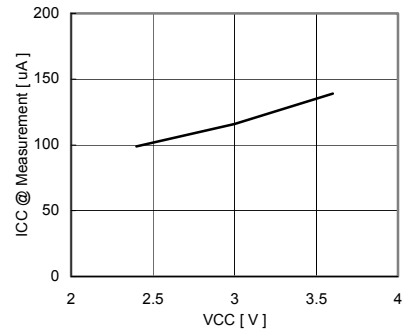

Fig.9 VCC - ICC (During ALS measurement)

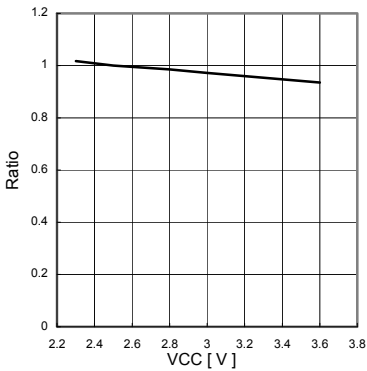

Fig.10 ALS Measurement Result VCC Dependency

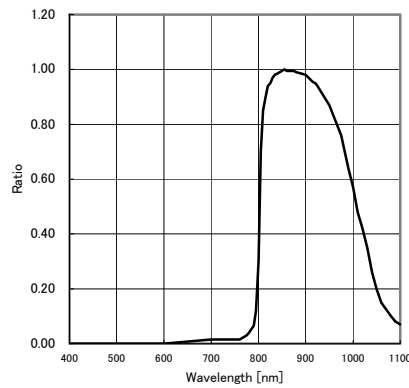

Fig.11 PS Spectral Response

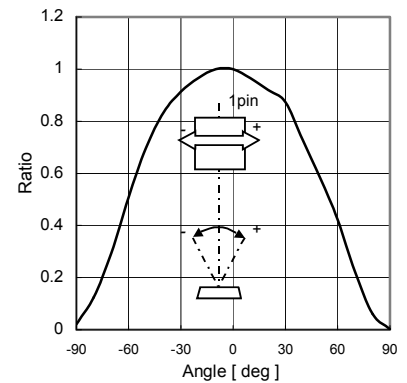

Fig.12 PS Directional Characteristics 1

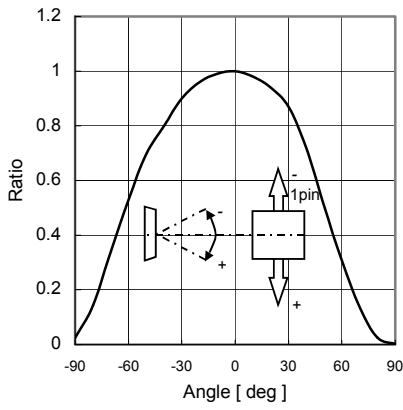

Fig.13 PS Directional Characteristics 2

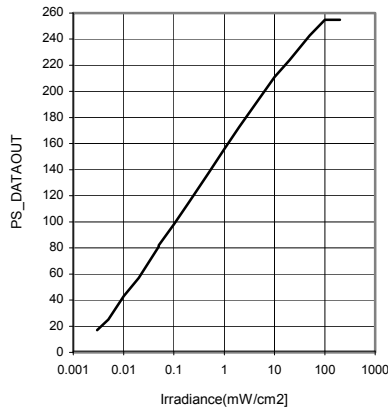

Fig.14 Irradiance – PS\_DATAOUT

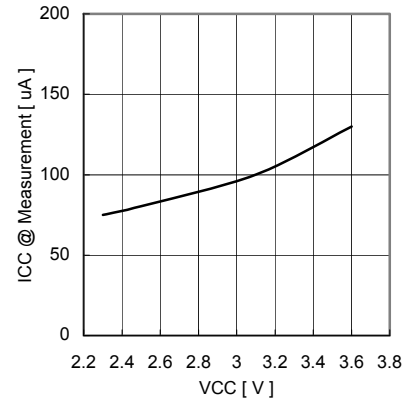

Fig.15 VCC - ICC (During PS measurement)

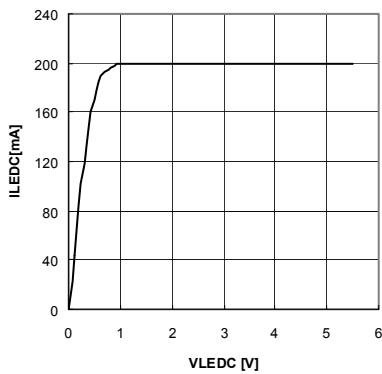

Fig.16 VLEDC – ILEDC@ ILED is set 200mA by ILED register

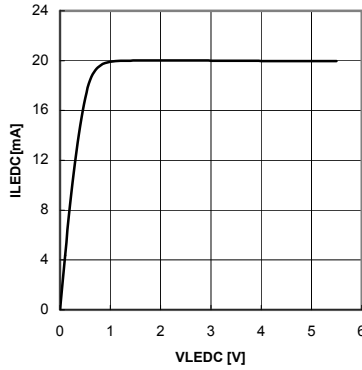

Fig.17 VLEDC – ILEDC@ ILED is set 20mA by ILED register

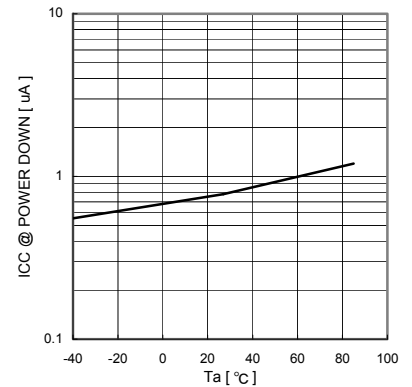

Fig.18 VCC – ICC@0 Lx (POWER DOWN)

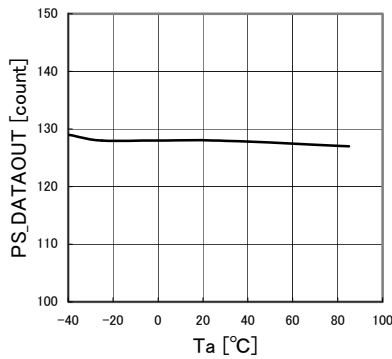

Fig.19 PS sensor out Temperature Dependency (Irradiance by Proximity object = 324μW/cm²)

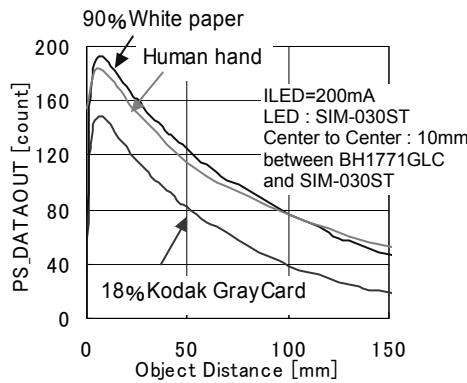

Fig.20 Object Distance – PS\_DATAOUT of different reflector

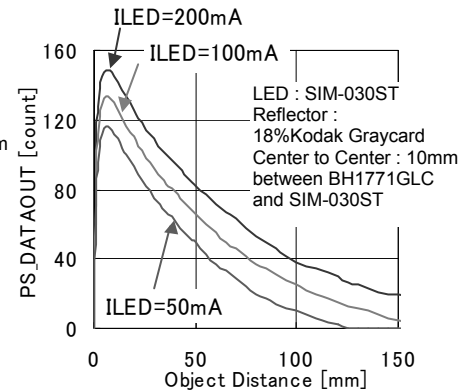

Fig.21 Object Distance – PS\_DATAOUT of different ILED

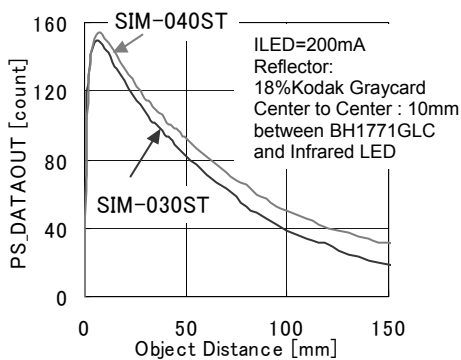

Fig.22 Object Distance – PS\_DATAOUT of different Infrared LED

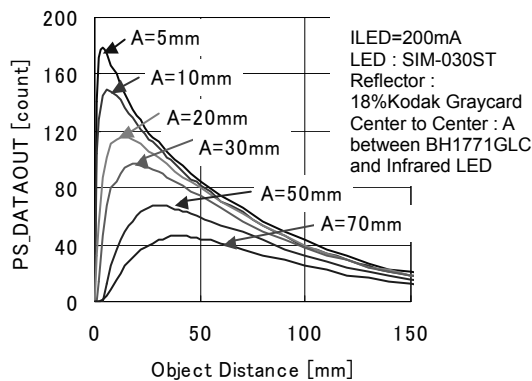

Fig.23 Object Distance – PS\_DATAOUT of different distance between BH1771GLC and SIM-030ST

• Fig.24-27 are PS\_DATAOUT measurement results which depend on the position of the reflector. The reflector is a White paper of reflectivity 90% and this size is 50mm×50mm. The characteristic of 90%White paper is nearly similar to human hand(human palm).

1) The reflector moves to the parallel direction for the position of BH1771GLC and LED.

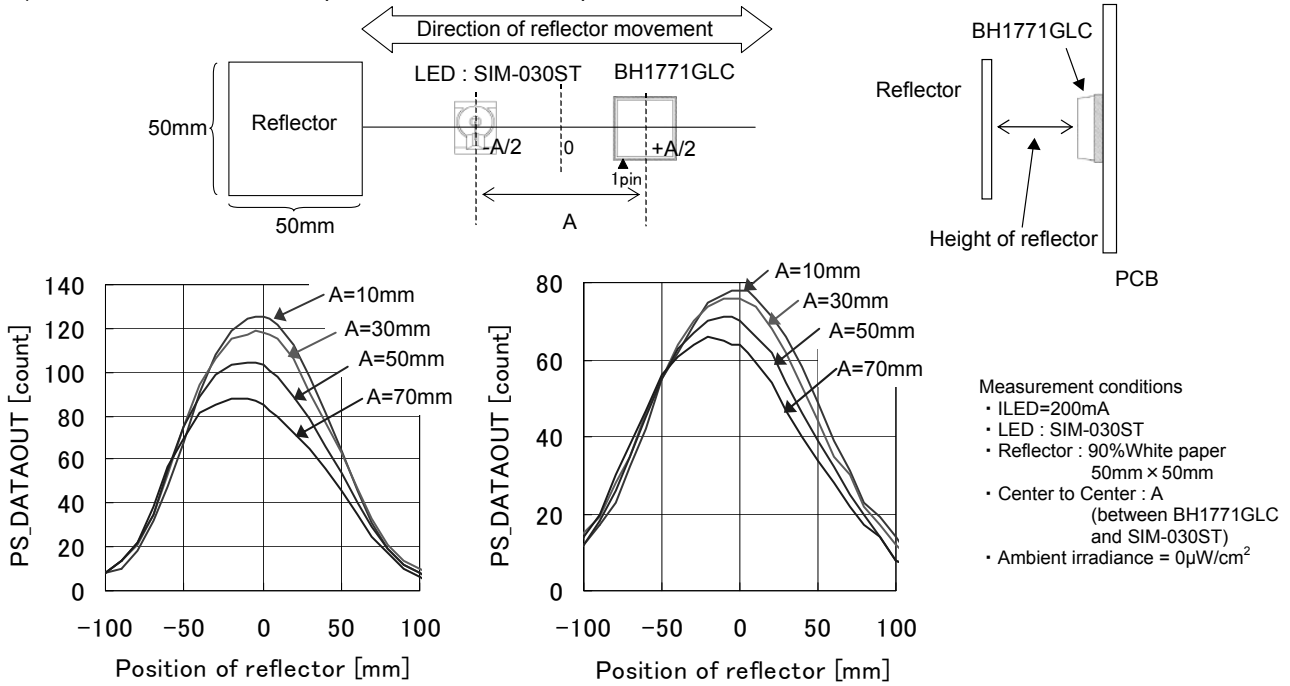

Fig.24 Position of reflector – PS\_DATAOUT  
Height of reflector is 50mm

Fig.25 Position of reflector – PS\_DATAOUT  
Height of reflector is 100mm

2) The reflector moves to the vertical direction for the position of BH1771GLC and LED.

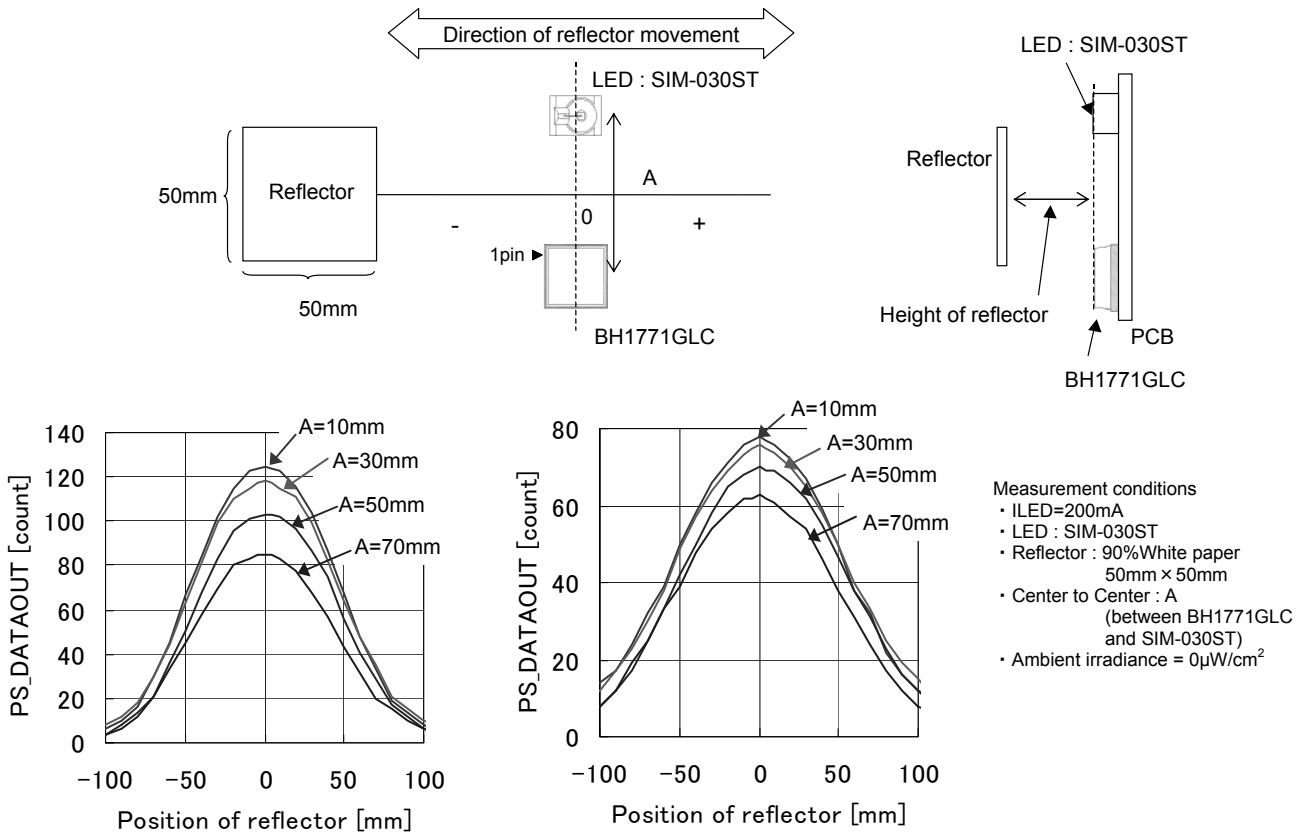

Fig.26 Position of reflector – PS\_DATAOUT  
Height of reflector is 50mm

Fig.27 Position of reflector – PS\_DATAOUT  
Height of reflector is 100mm

● I<sup>2</sup>C bus communication

1) Slave address "0111000"

2) Main write format

1. Case of "Indicate register address"



2. Case of "write to data register after indicating register address"

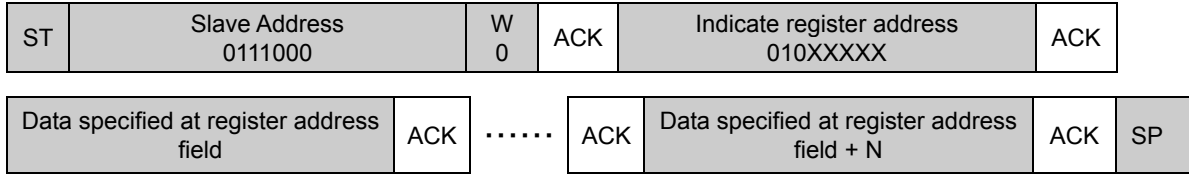

BH1771GLC continues to write data with address increments until master issues stop condition.  
Write cycle is 40h - 41h - 42h - 43h - 44h - 45h - 46h - 52h ..... 5Dh - 5Eh - 40h .....

Ex ) If register address field is 45h, then BH1771GLC writes data like seeing in below.  
45h - 46h -52h ..... 5Dh - 5Eh - 40h.....It is continued until master issues stop condition.

3) Main read format

1. Case of read data after indicate register address and read data ( Master issues restart condition )

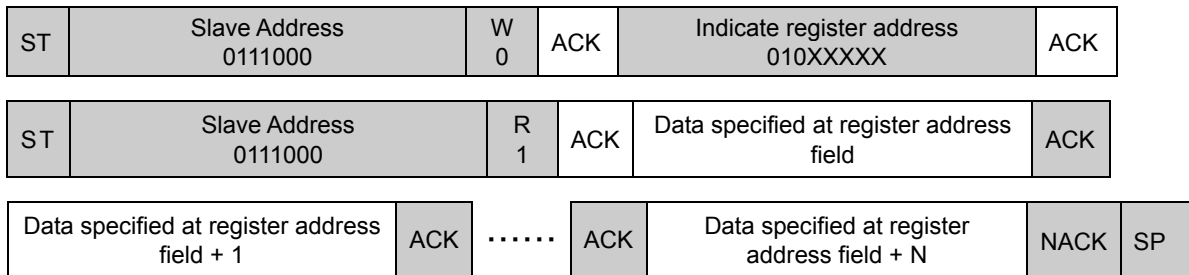

2. Case of read data after selecting register address

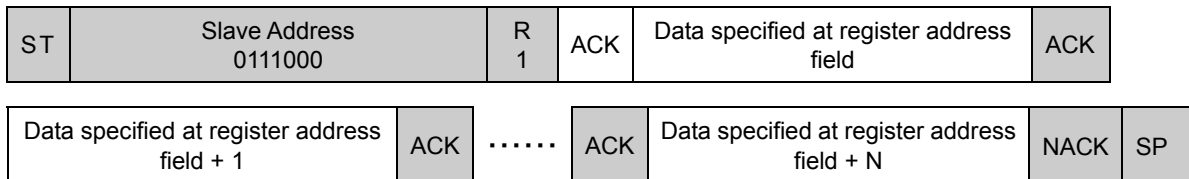

BH1771GLC outputs data from specified address field until master issues stop condition.  
Read cycle is 40h - 41h - 42h - 43h - 44h - 45h - 46h - 4Ah ..... 5Dh - 5Eh - 40h .....

Ex ) If register address field is 4Ch, then BH1771GLC outputs data like seeing in below.  
4Ch - 4Dh -4Eh ..... 5Dh - 5Eh - 40h.....It is continued until master issues stop condition.



※ BH1771GLC operates as I<sup>2</sup>C bus slave device.  
※ Please refer formality I<sup>2</sup>C bus specification of NXP semiconductors



● Block diagram and block explanation

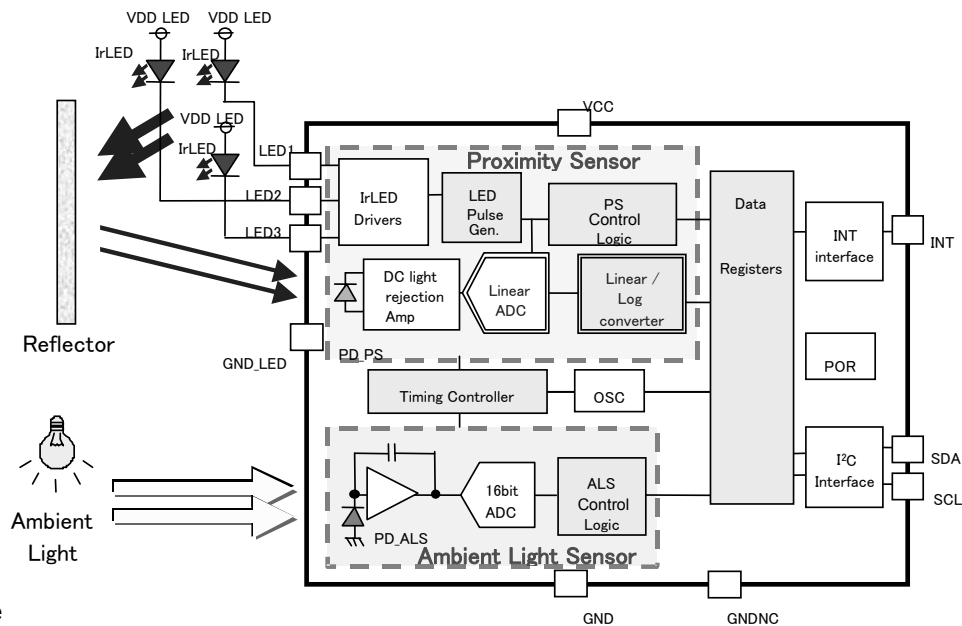

- I<sup>2</sup>C Interface  
I<sup>2</sup>C bus interface. f/s mode and Hs mode is supported. 1.8V logic interface is supported.
- POR  
Power on reset function.
- OSC  
Internal oscillator.
- Timing controller  
Internal management block for proximity sensor and ambient light sensor.
- INT interface  
INT terminal control block. Details are on Page 14 - 16
- DATA registers  
Register for storage of measurement results or commands. Details are on Page 17.
- PS control logic  
This block controls proximity sensor analog block
- LED Pulse Gen  
LED current generator. LED current value is configurable by ILED( 42h ) and ILED3( 43h ) register.
- IrLED Drivers.  
IrLED driver block. Active LED terminal is set by ILED( 42h ) register.
- PD\_ALS  
Photo diode for ambient light sensor. Peak wavelength is approximately 550nm.
- 16bit ADC  
AD converter for ALS.
- ALS control logic  
This block controls ambient light sensor analog block.
- PD\_PS  
Photo diode for proximity sensor. Peak wavelength is approximately 850nm.
- DC light rejection Amp  
DC light is rejected in this block. And generated Infrared pulse is passed to linear ADC block.
- Linear ADC  
AD converter for proximity sensor. Detection range is very wide (  $1\mu\text{W}/\text{cm}^2$  -  $100\text{mW}/\text{cm}^2$  ).
- Linear/Log converter  
Linear to logarithm converter for proximity sensor. Output data is 8bit.  
PS irradiance calculation example is on Page 26.

● Example of application circuit diagram

If you do not use the INT pin, please connect to GND or opening (non connect).

1) In case of using 1IrLED

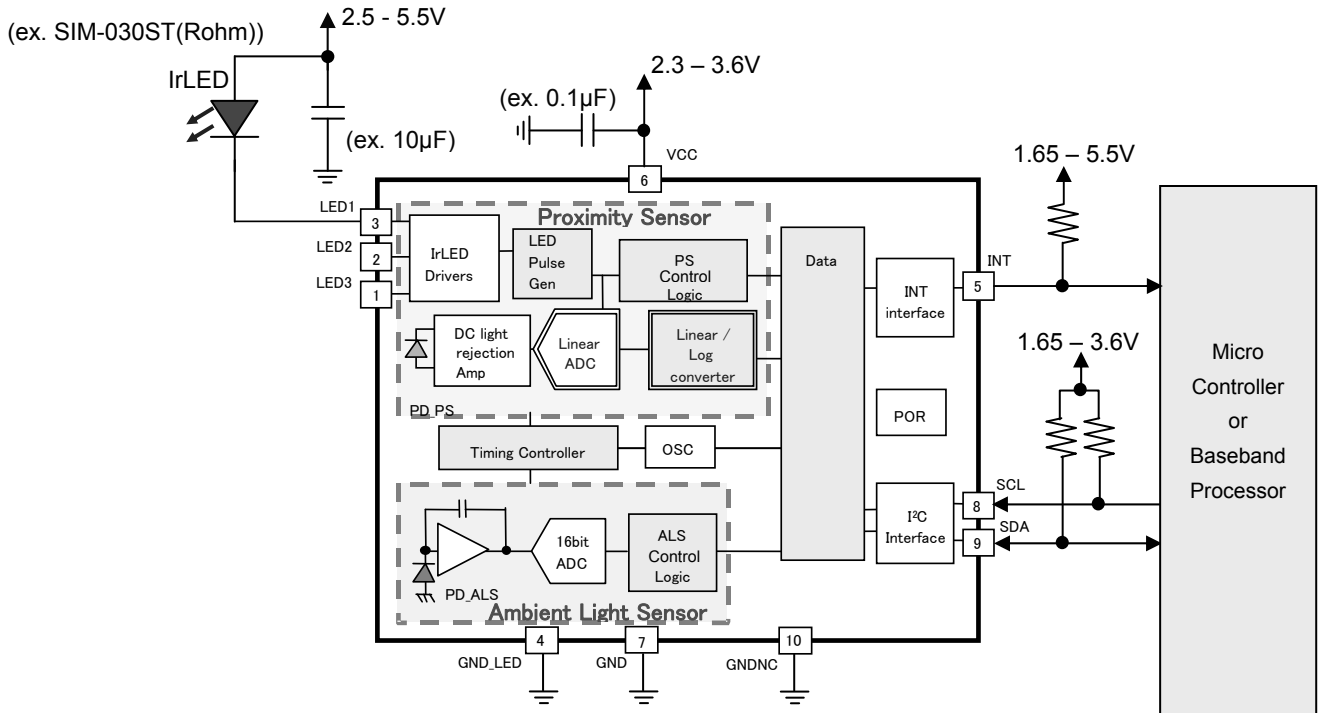

If you do not use the LED2 or LED3, please connect to VDD\_LED or opening (non connect).

2) In case of using 3 IrLEDs

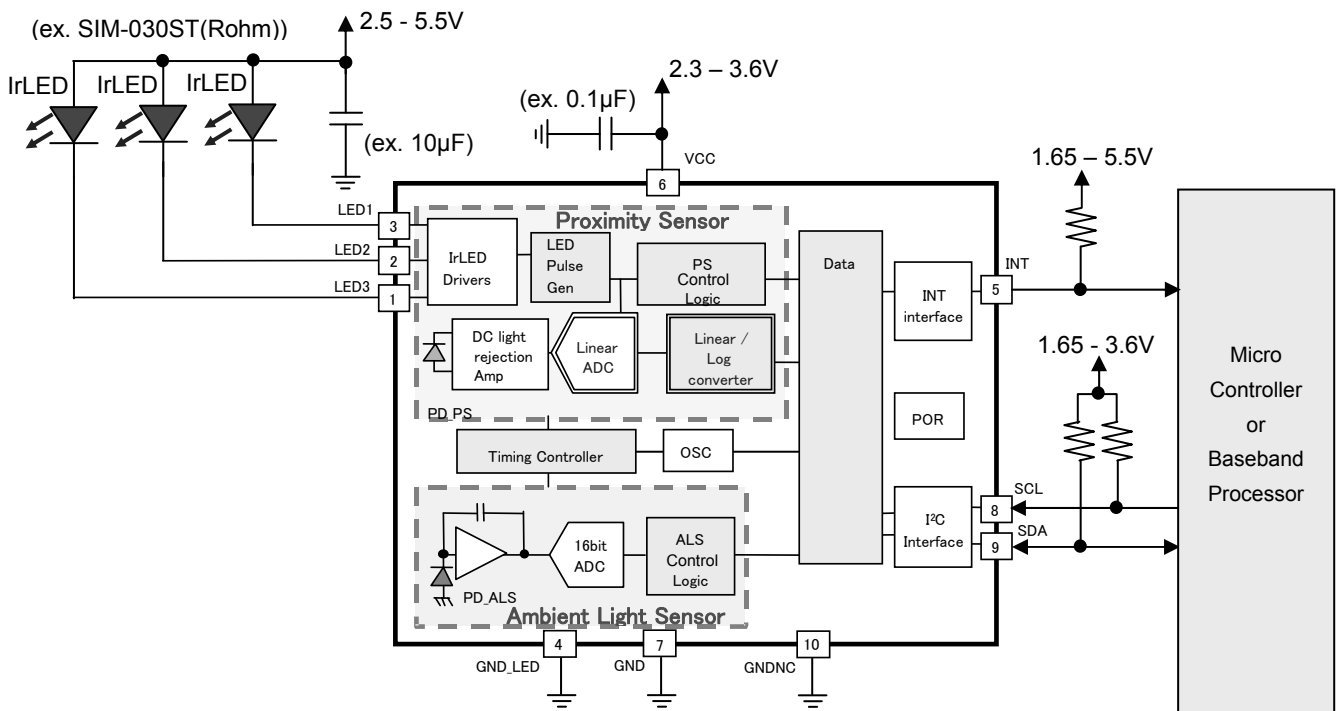

3) In case of extending proximity sensor detection distance  
 BH1771GLC can drive maximum 200mA(Typ) current. By adding simple external circuit, it is possible to increase IrLED current and to extend detection distance. In case of driving large current for IrLED, note that the current value must not be over the absolute maximum rating for IrLED.

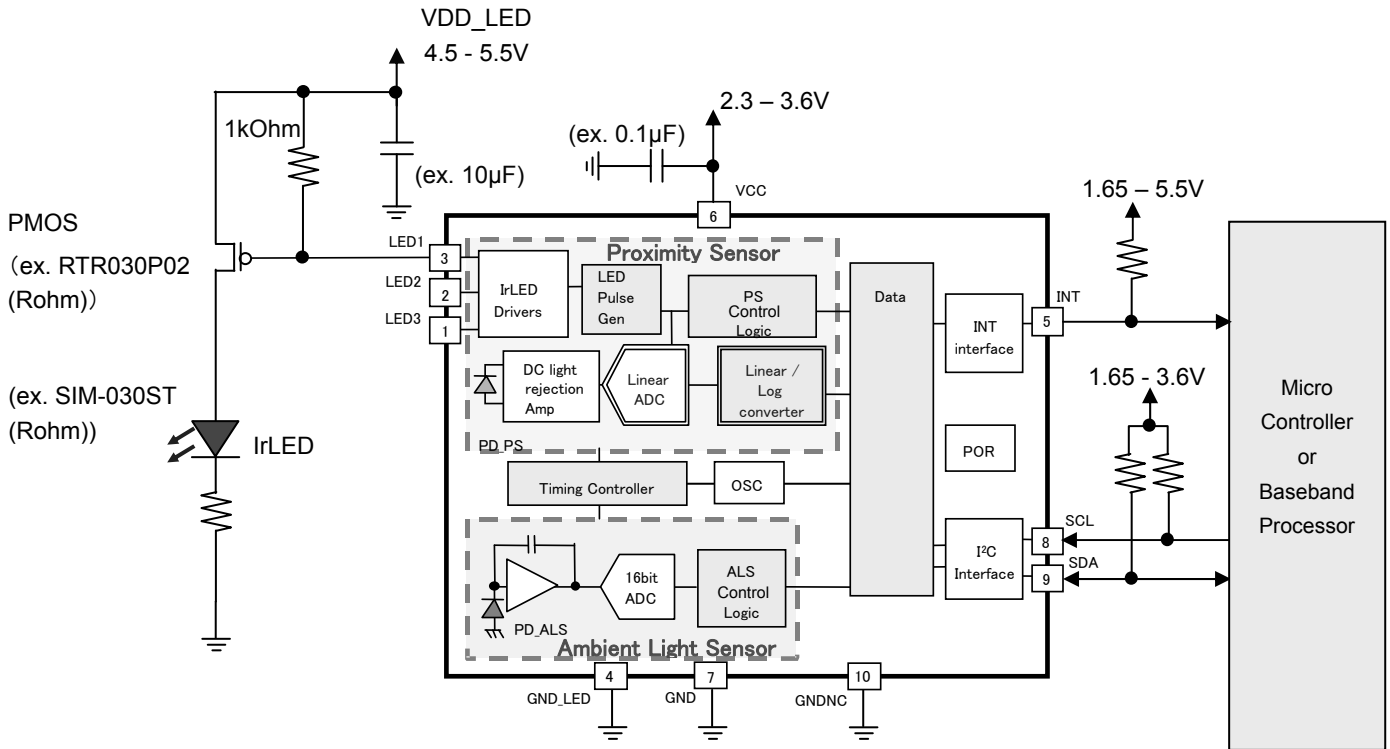

\* In the case of the following setting for above circuit, LED current is proximity 500mA.  
 VDD\_LED=5V, R1=3.9Ω

● Terminal description

PIN No.	Terminal Name	Equivalent Circuit	Function
1	LED3		Nch open drain LED3 terminal. LED current and emitting interval is defined by internal register. Register value is possible to configure by I <sup>2</sup> C bus.
2	LED2		Nch open drain LED2 terminal. LED current and emitting interval is defined by internal register. Register value is possible to configure by I <sup>2</sup> C bus.
3	LED1		Nch open drain LED1 terminal. LED current and emitting interval is defined by internal register. Register value is possible to configure by I <sup>2</sup> C bus.
4	GND_LED		GND terminal for LED driver
5	INT		Nch open drain output. Interrupt setting is defined by internal register. Register value is possible to configure by I <sup>2</sup> C bus.
6	VCC		Power supply terminal
7	GND		GND terminal
8	SCL		I <sup>2</sup> C bus Interface SCL terminal
9	SDA		I <sup>2</sup> C bus Interface SDA terminal
10	GNDNC		Non connect or pull down to GND

If you do not use the INT pin, please connect to GND or opening (non connect).

If you do not use the LED2 or LED3, please connect to VDD\_LED or opening (non connect).

● Proximity sensor measurement sequence

The below figure shows proximity sensor measurement sequence. First PS measurement is triggered by I<sup>2</sup>C bus master writes measurement command to PS\_CONTROL register ( 41h ). BH1771GLC has 3 LED-drivers and their combinations are set by ILED,ILED3 register ( 42h, 43h ). In the case of only LED2 is inactive, LED3 emit immediately after LED1 emission.

1. Forced mode

PS measurement is done only 1time and PS trigger bit ( 44h<0> ) is overwritten from 'H' to 'L' after PS measurement complete. PS measurement is re-started by master writes PS trigger bit to 'H'.

2. Stand alone mode

PS measurement is continuously done until master select the other mode. Measurement interval is defined at PS\_MEAS\_RATE register ( 45h ).

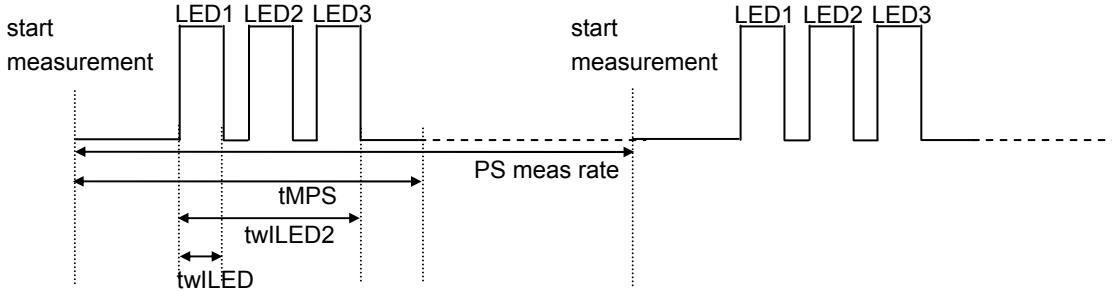

- twILED : LED current pulse duration, please refer P2 ( Electrical Characteristics ).
- twILED2 : Cumulative LED current pulse duration, please refer P2 ( Electrical Characteristics ).
- tMPS : Proximity sensor measurement time, please refer P2 ( Electrical Characteristics ).  
Measurement result is generated in this term.
- PS meas rate: In case of stand alone mode, It is defined at PS\_MEAS\_RATE register ( 45h ).  
In case of forced mode, it means the term until overwriting PS trigger bit to 'H'.

● Ambient light sensor measurement sequence

The below figure shows ambient light sensor measurement sequence. First ALS measurement is triggered by I2C bus master writing measurement command to ALS\_CONTROL register ( 40h ).

1. Forced mode

ALS measurement is done only 1time and ALS trigger bit( 44h<1> ) is overwritten from 'H' to 'L' after ALS measurement is completed. ALS measurement is re-started by master writes ALS trigger bit to 'H'.

2. Stand alone mode

ALS measurement is continuously done until master select the other mode. Measurement interval is defined at ALS\_MEAS\_RATE register ( 46h ). If ALS rate disable bit ( 46h<7> ) is 'H', there is no interval between measurement.

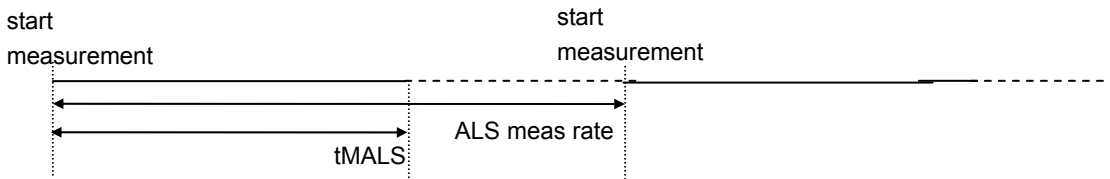

- tMALS : Ambient light sensor measurement time, please refer P2 ( Electrical Characteristics ).  
Measurement result is generated in this term.
- ALS meas rate : In case of stand alone mode, It is defined at ALS\_MEAS\_RATE register ( 46h )  
In case of forced mode, it means the term until overwriting ALS trigger bit to 'H'.

●Interrupt function

Interrupt function compares ALS or PS measurement result to preset interrupt threshold level. PS uses one threshold level or two threshold level ( in hysteresis mode ) and ALS uses two threshold level (upper and lower ). Interrupt status is monitored by INT pin or ALS\_PS\_STATUS register ( 4Eh ) and Interrupt function is able to be controlled by INTERRUPT register ( 52h ). Interrupt threshold is defined at ALS\_TH\_UP and ALS\_TH\_LOW and PS\_TH\_LED and PS\_TH\_L\_LED registers ( 53h - 59h, 5Ch - 5Eh ). PS\_TH\_L\_LED registers are effective when PS hysteresis bit ( 52h<4> ) is 'H'.

Interrupt persistence function is defined at PERSISTENCE register ( 5Bh ).

INT pin is Nch open drain terminal so this terminal should be pull-up to some kind of voltage source by an external resistor. Maximum sink current rating of this terminal is 7mA.

There are two output modes about interrupt function ( latched mode and unlatched mode ).

In case of using ALS and PS interrupt functions at the same time, latch mode is recommended.

INT terminal is high impedance when VCC is supplied.

INT terminal becomes inactive by setting INTERRUPT register (52h)[1:0] to "00". ( It is not worked during power down mode.

Power down mode means ALS\_CONTROL(40h)<1>='0' and PS\_CONTROL(41h)<1> = '0'.)

INT terminal keeps just previous state which power down command is sent. So to set INT terminal to high impedance is recommended. VCC current(approximately 25µA at VCC=2.5V) is consumed during INT terminal is 'L'. There are two method to set INT terminal to high impedance.

1) Send software reset command. (Write 'H' to ALS\_CONTROL(40h)<2>. Software reset is also worked during power down.

All registers are initialized by software reset command.)

2) Write "000" to INTERRUPT register(52h)<2:0>.

ex1) In case of using PS 'H' threshold (INTERRUPT register 52h<4> : '0')

In case of unlatch mode if the measurement value exceed the PS interrupt threshold 'H' value, the interrupt becomes active. And if the measurement value goes below the threshold, the interrupt becomes inactive.

In case of latch mode once the interrupt becomes active, it keeps the status until end of measurement after INTERRUPT register is read.

In case of persistence function is set to active, if the interrupt is inactive, it keeps inactive status until the measurement value is beyond the threshold 'H' value continuously. If the interrupt is active, it keeps active status until the measurement value is below threshold 'H' value continuously or until end of measurement after INTERRUPT register is read.

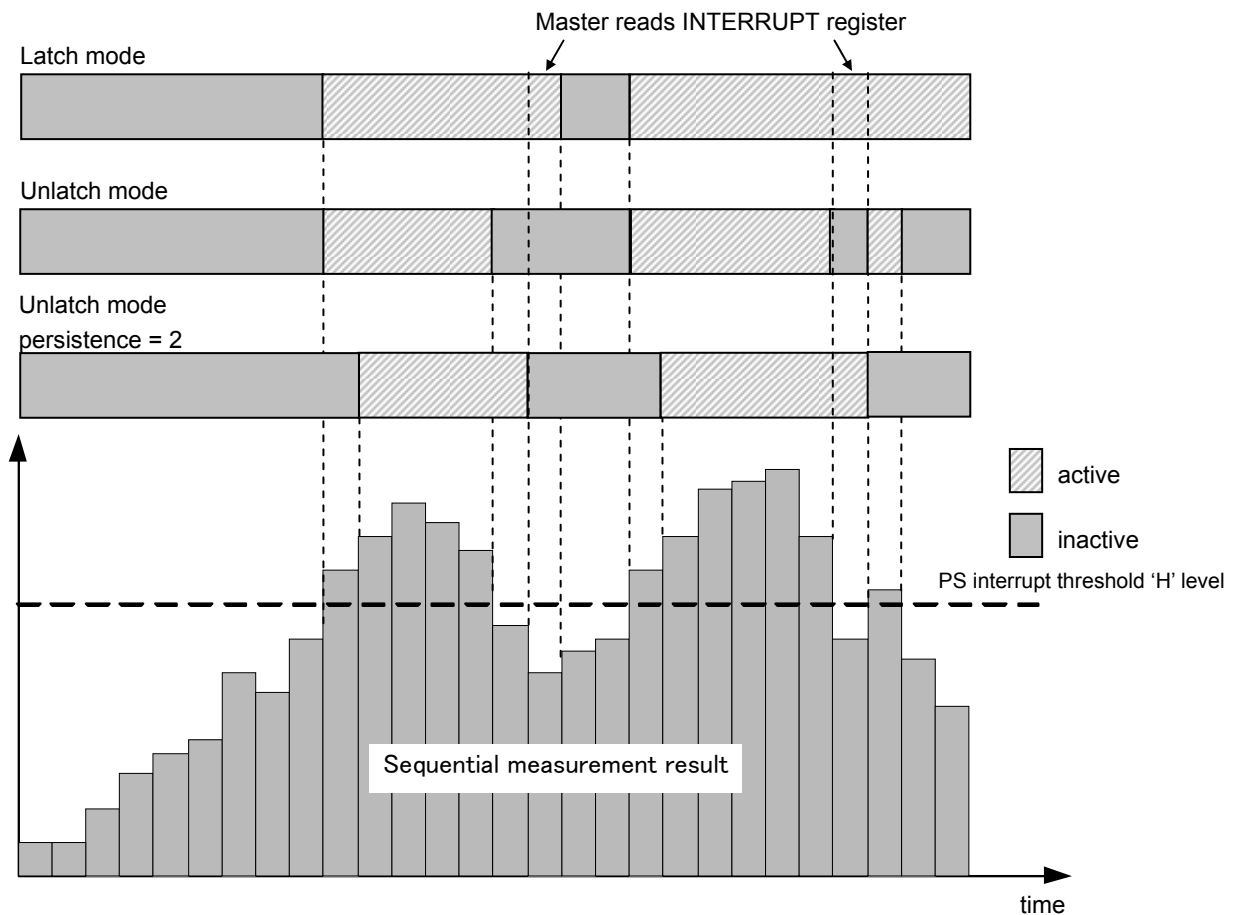

ex2 ) In case of using PS 'H/L' threshold (( INTERRUPT register 52h<4> : '1')

In case of unlatch mode if the measurement value exceed the PS interrupt threshold 'H' value, the interrupt becomes active. And if the measurement value is below the threshold "L" value, the interrupt becomes inactive.

In case of latch mode once the interrupt becomes active, it keeps the status until end of measurement after INTERRUPT register is read.

In case of persistence function is set to active, if the interrupt is inactive, it keeps inactive status until the measurement value is beyond the threshold 'H' value continuously. If the interrupt is active, it keeps active status until the measurement value is below threshold "L" value continuously or until end of measurement after INTERRUPT register is read.

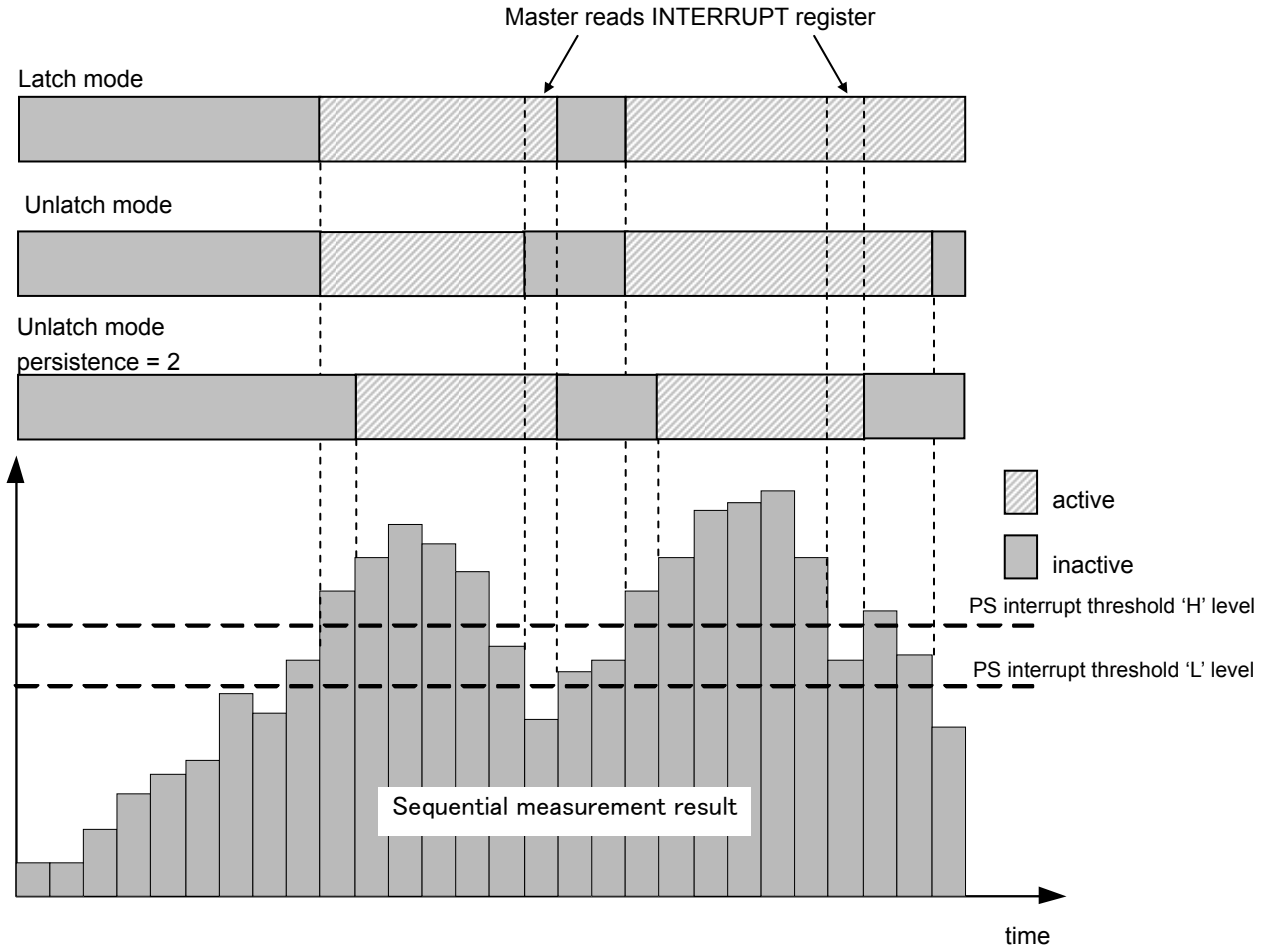

ex3 ) Ambient light sensor interrupt function

In case of unlatch mode if the measurement value is within the range set by ALS interrupt threshold 'H' and "L" value, the interrupt becomes inactive. And if the measurement value is out of the range set by threshold 'H' and "L" value, the interrupt becomes active.

In case of latch mode once the interrupt becomes active, it keeps the status until end of measurement after INTERRUPT register is read.

In case that persistence function is set to active, if the interrupt is inactive, it keeps inactive status until the measurement value is continuously out of the range set by threshold 'H' and "L" value. If the interrupt is active, it keeps active status until the measurement value is continuously within the range set by threshold 'H' and "L" value or until end of measurement after INTERRUPT register is read.

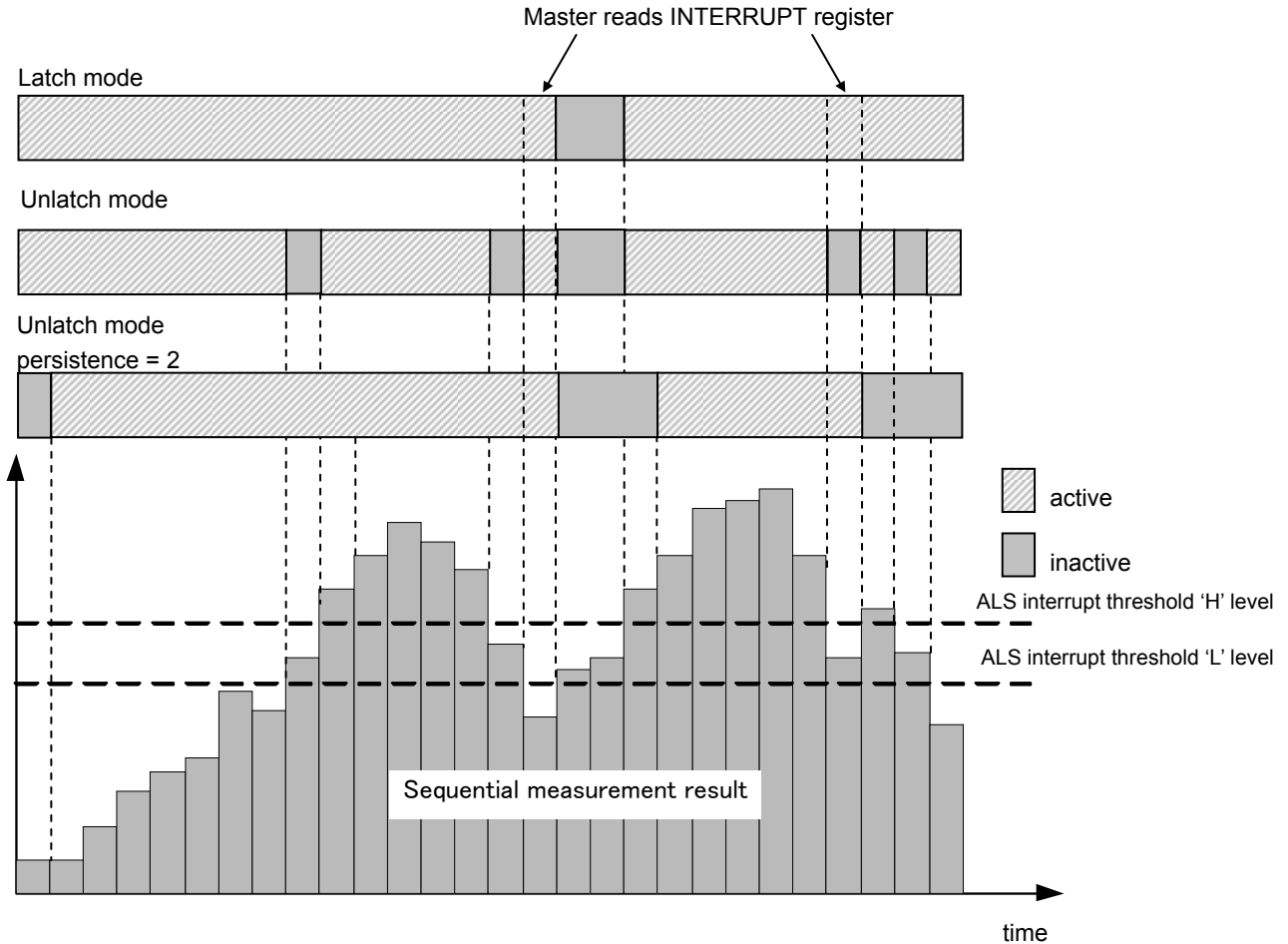



## ●Command set

Address	Type	Register name	Register function
40h	RW	ALS_CONTROL	ALS operation mode control and SW reset
41h	RW	PS_CONTROL	PS operation mode control
42h	RW	I_LED	Selection of active LED and LED1, LED2 current setting
43h	RW	I_LED3	LED3 current setting
44h	RW	ALS_PS_MEAS	Forced mode trigger
45h	RW	PS_MEAS_RATE	PS measurement rate
46h	RW	ALS_MEAS_RATE	ALS measurement rate
4Ah	R	-	Reserved
4Bh	R	MANUFACT_ID	Manufacturer ID
4Ch	R	ALS_DATA_0	ALS data (Low Byte)
4Dh	R	ALS_DATA_1	ALS data (High Byte)
4Eh	R	ALS_PS_STATUS	Measurement data and interrupt status
4Fh	R	PS_DATA_LED1	PS data from LED1
50h	R	PS_DATA_LED2	PS data from LED2
51h	R	PS_DATA_LED3	PS data from LED3
52h	RW	INTERRUPT	Interrupt setting
53h	RW	PS_TH_LED1	PS interrupt H threshold for LED1
54h	RW	PS_TH_LED2	PS interrupt H threshold for LED2
55h	RW	PS_TH_LED3	PS interrupt H threshold for LED3
56h	RW	ALS_TH_UP_0	ALS upper threshold low byte
57h	RW	ALS_TH_UP_1	ALS upper threshold high byte
58h	RW	ALS_TH_LOW_0	ALS lower threshold low byte
59h	RW	ALS_TH_LOW_1	ALS lower threshold high byte
5Ah	RW	ALS_SENSITIVITY	ALS sensitivity setting
5Bh	RW	PERSISTENCE	INT pin INTERRUPT persistence setting
5Ch	RW	PS_TH_L_LED1	PS interrupt L threshold for LED1
5Dh	RW	PS_TH_L_LED2	PS interrupt L threshold for LED2
5Eh	RW	PS_TH_L_LED3	PS interrupt L threshold for LED3

## ○ ALS\_CONTROL (40h)

7	6	5	4	3	2	1	0
RES	RES	RES	RES	ALS Resolution	SW Reset	ALS mode	

default value 00h

Field	Bit	Type	Description
RES	7 : 4	RW	Write 0000
ALS Resolution	3	RW	0 : H-Resolution mode, 1 lx step output 1 : M-Resolution mode, 4 lx step output
SW reset	2	RW	0 : initial reset is not started 1 : initial reset is started
ALS mode	1 : 0	RW	00 : Standby mode 01 : Don't use. 10 : Forced mode 11 : Stand alone mode

## ○ PS\_CONTROL (41h)

7	6	5	4	3	2	1	0
X	X	X	X	X	X	PS mode	

default value 00h

Field	Bit	Type	Description
NA	7 : 2	-	Ignored
PS mode	1 : 0	RW	00 : Standby mode 01 : Don't use. 10 : Forced mode 11 : Stand alone mode

## ○ I\_LED (42h)

7	6	5	4	3	2	1	0
PS active		LED2 current			LED1 current		

default value 1Bh

Field	Bit	Type	Description
PS active	7 : 6	RW	00 : LED1 is active, LED2,3 are inactive 01 : LED1,2 are active, LED3 is inactive 10 : LED1,3 are active, LED2 is inactive 11 : All LEDs are active
LED2 current	5 : 3	RW	000 : 5mA 001 : 10mA 010 : 20mA 011 : 50mA
LED1 current	2 : 0	RW	100 : 100mA 101 : 150mA 11X : 200mA

## ○ I\_LED3 ( 43h )

7	6	5	4	3	2	1	0
X	X	X	X	X	LED3 current		

default value 03h

Field	Bit	Type	Description
NA	7 : 3	-	Ignored
LED3 current	2 : 0	RW	000 : 5mA 001 : 10mA 010 : 20mA 011 : 50mA 100 : 100mA 101 : 150mA 11X : 200mA

## ○ ALS\_PS\_MEAS ( 44h )

7	6	5	4	3	2	1	0
X	X	X	X	X	X	ALS trigger	PS trigger

default value 00h

Field	Bit	Type	Description
NA	7 : 2	-	Ignored
ALS trigger	1	RW	0 : Ignored 1 : Start ALS measurement at force mode <sup>*2</sup>
PS trigger	0	RW	0 : Ignored 1 : Start PS measurement at force mode <sup>*2</sup>

<sup>\*2</sup> Even if trigger is set during measurement, the measurement doesn't start. The measurement will start, in case that It is set to forced mode by ALS\_CONTROL register (40h) or PS\_CONTROL register (41h) and is not during measurement.

○ PS\_MEAS\_RATE ( 45h )

7	6	5	4	3	2	1	0
X	X	X	X	PS meas rate			

default value 05h

Field	Bit	Type	Description
NA	7 : 4	-	Ignored
PS meas rate	3 : 0	RW	0000 : 10ms 0001 : 20ms 0010 : 30ms 0011 : 50ms 0100 : 70ms 0101 : 100ms 0110 : 200ms 0111 : 500ms 1000 : 1000ms 1001 : 2000ms 101X : 2000ms 11XX : 2000ms

○ ALS\_MEAS\_RATE ( 46h )

7	6	5	4	3	2	1	0
ALS rate disable	X	X	X	X	ALS meas rate		

default value 02h

Field	Bit	Type	Description
ALS rate disable	7	RW	0 : ALS meas rate( 46h<2:0> ) is active 1 : ALS meas rate( 46h<2:0> ) is inactive
NA	6 : 3	-	Ignored
ALS meas rate	2 : 0	RW	000 : 100ms 001 : 200ms 010 : 500ms 011 : 1000ms 1XX : 2000ms

○ ( 4Ah )

7	6	5	4	3	2	1	0
X	X	X	X	X	X	X	X

default value 93h

Field	Bit	Type	Description
NA	7 : 0	R	Reserved

## ○ MANUFACT\_ID ( 4Bh )

7	6	5	4	3	2	1	0
Manufacturer ID							

default value 01h

Field	Bit	Type	Description
Manufacturer ID	7 : 0	R	00000001

## ○ ALS\_DATA ( 4Ch, 4Dh )

7	6	5	4	3	2	1	0
ALS data							

default value 00h

Register	Address	Bit	Type	Description
ALS data LSBs	4Ch	7 : 0	R	ALS data Low byte
ALS data MSBs	4Dh	7 : 0	R	ALS data High byte

## ○ ALS\_PS\_STATUS ( 4Eh )

7	6	5	4	3	2	1	0
ALS INT status	ALS data status	LED3 INT status	LED3 data status	LED2 INT status	LED2 data status	LED1 INT status	LED1 data status

default value 00h

Field	Bit	Type	Description
ALS INT status	7	R	0 : ALS interrupt signal inactive 1 : ALS interrupt signal active
ALS data status	6	R	0 : ALS old data (data is already read) 1 : ALS new data (data is renewed after previous reading)
LED3 INT status	5	R	0 : LED3 interrupt signal inactive 1 : LED3 interrupt signal active
LED3 data status	4	R	0 : LED3 old data (data is already read) 1 : LED3 new data (data is renewed after previous reading)
LED2 INT status	3	R	0 : LED2 interrupt signal inactive 1 : LED2 interrupt signal active
LED2 data status	2	R	0 : LED2 old data (data is already read) 1 : LED2 new data (data is renewed after previous reading)
LED1 INT status	1	R	0 : LED1 interrupt signal inactive 1 : LED1 interrupt signal active
LED1 data status	0	R	0 : LED1 old data (data is already read) 1 : LED1 new data (data is renewed after previous reading)

ALS interrupt signal inactive means that ALS measurement result is within threshold level set by ALS\_TH register(56h, 57h, 58h, 59h). ALS interrupt signal active means measurement result is out of threshold level set by ALS\_TH register. PS interrupt signal active means each PS measurement result exceeds threshold level defined by PS\_TH\_LED register(53h, 54h, 55h). PS interrupt signal inactive means each PS measurement result does not exceed threshold level set by PS\_TH\_LED register. When PS interrupt hysteresis( INTERRUPT register 52h<4>) is 'H', if once interrupt signal becomes active, it is kept until measurement result becomes less than PS\_TH\_L\_LED( 5Ch 5Dh 5Eh) register value. Regarding ALS and LED1, it is possible to set persistence (5Bh).

## ○ PS\_DATA\_LED ( 4Fh, 50h, 51h)

7	6	5	4	3	2	1	0
LED data							

default value 00h

Register	Address	Bit	Type	Description
LED1 data	4Fh	7 : 0	R	PS measurement data for each LED
LED2 data	50h	7 : 0	R	
LED3 data	51h	7 : 0	R	

## ○ INTERRUPT ( 52h )

7	6	5	4	3	2	1	0
X	Interrupt source		PS Interrupt hysteresis	Output mode	Interrupt polarity	Interrupt mode	

default value 08h

Field	Bit	Type	Description
NA	7	-	Ignored
Interrupt source	6 : 5	R	00 : First interrupt triggered by ALS 01 : First interrupt triggered by LED1 10 : First interrupt triggered by LED2 11 : First interrupt triggered by LED3
PS Interrupt hysteresis	4	RW	0 : Use PS_TH_LED only. 1 : Use PS_TH_LED and PS_TH_L_LED for hysteresis
Output mode	3	RW	0 : INT pin is latched until INTERRUPT register is read. 1 : INT pin is updated after each measurement.
Interrupt polarity	2	RW	0 : INT pin is logic "L" when interrupt signal is active 1 : INT pin is logic "L" when interrupt signal is inactive
Interrupt mode	1 : 0	RW	00 : INT pin is inactive. 01 : Triggered by only PS measurement 10 : Triggered by only ALS measurement 11 : Triggered by PS and ALS measurement

## ○ PS\_TH\_LED ( 53h, 54h, 55h)

7	6	5	4	3	2	1	0
LED threshold							

default value FFh

Register	Address	Bit	Type	Description
LED1 threshold	53h	7 : 0	RW	PS H threshold for each LED
LED2 threshold	54h	7 : 0	RW	
LED3 threshold	55h	7 : 0	RW	

## ○ ALS\_TH\_UP ( 56h, 57h )

7	6	5	4	3	2	1	0
ALS upper threshold data							

default value FFh

Register	Address	Bit	Type	Description
ALS TH upper LSBs	56h	7 : 0	RW	ALS interrupt upper threshold (Low byte)
ALS TH upper MSBs	57h	7 : 0	RW	ALS interrupt upper threshold (High byte)

## ○ ALS\_TH\_LOW ( 58h, 59h )

7	6	5	4	3	2	1	0
ALS lower threshold data							

default value 00h

Register	Address	Bit	Type	Description
ALS TH lower LSBs	58h	7 : 0	RW	ALS interrupt lower threshold (Low byte)
ALS TH lower MSBs	59h	7 : 0	RW	ALS interrupt lower threshold (High byte)

## ○ ALS\_SENSITIVITY ( 5Ah )

7	6	5	4	3	2	1	0
ALS sensitivity data							

default value 35h

Register	Bit	Type	Description
ALS sensitivity data	7 : 0	RW	ALS sensitivity adjustment register (refer to P27)

## ○ PERSISTENCE ( 5Bh )

7	6	5	4	3	2	1	0
ALS persistence				PS LED1 persistence			

default value 11h

Field	Bit	Type	Description
ALS persistence	7 : 4	RW	Persistence for ALS interrupt.
PS LED1 persistence	3 : 0	RW	Persistence for PS LED1 interrupt.

## ○ PS\_TH\_L\_LED ( 5Ch, 5Dh, 5Eh )

7	6	5	4	3	2	1	0
LED L threshold							

default value 00h

Register	Address	Bit	Type	Description
LED1 L threshold	5Ch	7 : 0	RW	PS L threshold for each LED
LED2 L threshold	5Dh	7 : 0	RW	
LED3 L threshold	5Eh	7 : 0	RW	

## ● Current consumption

BH1771GLC can operate ALS and PS individually. Average current consumption is depend on each statuses and measurement duration (set by 45h, 46h register). Major elements which decide VCC current consumption are like following table.

Parameter	Symbol	Typ.	Units	Comment
ALS part's current	IccALS	140	μA	Except for ALS/PS common circuit current.
PS part's current	IccPS	250	μA	Except for ALS/PS common circuit current. Current flow for 1.4ms (in case of using one LED) Current flow for 1.8ms (in case of using two LEDs) Current flow for 2.2ms (in case of using three LEDs)
PS current during driving LED	Icc3	6.5	mA	
ALS/PS common circuit current	Icccmn	60	μA	

- 1) Current consumption in case of operating only ALS  
VCC current consumption can calculate according to following formula.

$$ICC(\text{only ALS}) = IccALS * (100ms / ALS \text{ meas rate} ) + Icccmn$$

For example in case measurement rate is 500ms, the value is as following.

$$\text{e. g. ) } ICC(\text{only ALS}) = 140\mu A (100ms / 500ms) + 60\mu A = 88\mu A$$

- 2) Current consumption in case of operating only PS  
VCC current consumption can calculate according to following formula.

$$ICC(\text{only PS}) = IccPS * (1.4ms / PS \text{ meas rate} ) + Icccmn + Icc3 * (200\mu s / PS \text{ meas rate} * \text{number of LEDs} )$$

VDD\_LED current consumption can calculate according to following formula.

$$IVDD\_LED = (ILED1 + ILED2 + ILED3) * (200\mu s / PS \text{ meas rate} )$$

For example in case it drives 50mA for only LED1 and measurement rate is 100ms, the value is as following.

$$\text{e. g. ) } ICC(\text{only PS}) = 250\mu A * (1.4ms / 100ms) + 60\mu A + 6.5mA * (200\mu s / 100ms * 1) = 76.5\mu A$$

$$IVDD\_LED = (50mA + 0 + 0) * (200\mu s / 100ms) = 100\mu A$$

For example in case it drive 200mA for LED1,2 and 3 and measurement rare is 10ms, the value is as following.

$$\text{e. g. ) } ICC(\text{only PS}) = 250\mu A * (2.2ms / 10ms) + 60\mu A + 6.5mA * (200\mu s / 10ms * 3) = 505\mu A$$

$$IVDD\_LED = (200mA + 200mA + 200mA) * (200\mu s / 10ms) = 12mA$$

- 3) Current consumption in case of operating ALS and PS at the same time.  
VCC current consumption can calculate according to following formula.

$$ICC(\text{ALS+PS}) = ICC(\text{only ALS}) + ICC(\text{only PS}) - Icccmn$$

For example in case ALS measurement rate is 500ms and PS measurement rate is 100ms and it drives 50mA for only LED1, the value is as following.

$$\text{e.g. ) } ICC(\text{ALS+PS}) = 88\mu A + 76.5\mu A - 60\mu A = 104.5\mu A$$

VDD\_LED current consumption can calculate same as the case of operating only PS.

- 4) I<sup>2</sup>C bus High speed mode  
BH1771GLC support I<sup>2</sup>C bus Hs mode. VCC current consumption increases approximately 80μA during Hs- mode.



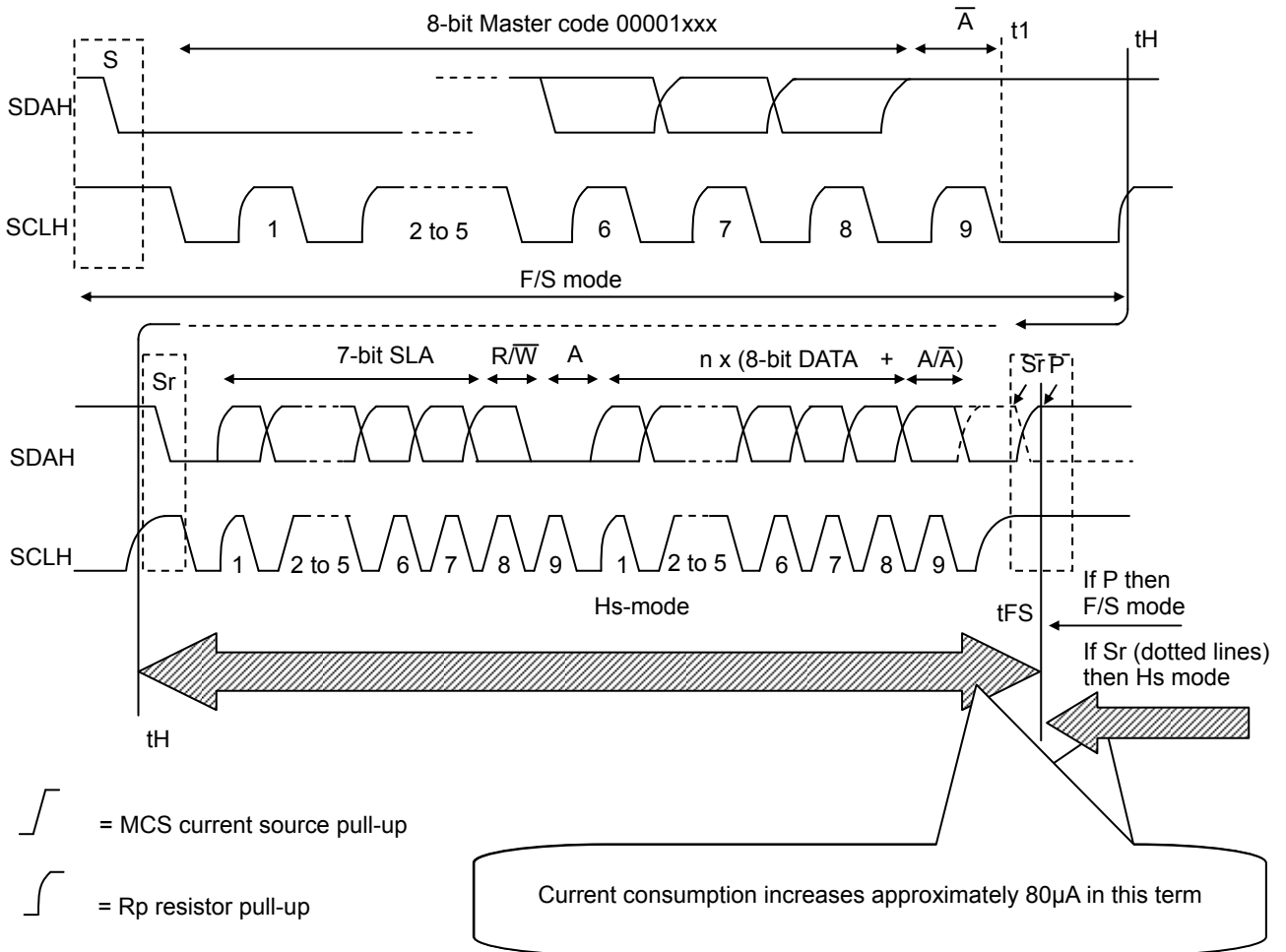

5) In case of waiting trigger at forced mode ALS/PScommon cucuit current (lccmn) is flow.

●ALS Measurement mode explanation

Measurement Mode	Measurement Time	Resolution
H-Resolution mode	typ. 100ms.	1 Lx
M-Resolution mode	typ.16ms.	4 Lx

We recommend to use H-Resolution Mode.

Measurement time ( integration time ) of H-Resolution mode is so long that some kind of noise( including in 50Hz / 60Hz noise ) is rejected. And H-Resolution mode is 1 lx resolution so that it is suitable for darkness.

●Regarding ALS measurement result

ALS measurement result is registered as following format

ALS DATA LSB ( 4Ch )

7	6	5	4	3	2	1	0
$2^7$	$2^6$	$2^5$	$2^4$	$2^3$	$2^2$	$2^1$	$2^0$

ALS DATA MSB ( 4Dh )

7	6	5	4	3	2	1	0
$2^{15}$	$2^{14}$	$2^{13}$	$2^{12}$	$2^{11}$	$2^{10}$	$2^9$	$2^8$

ALS Lux calculation example

ALS DATA LSB = " 1001\_0000 "

ALS DATA MSB = " 1000\_0011 "

$$( 2^{15} + 2^9 + 2^8 + 2^7 + 2^4 ) \div 33680 [ lx ]$$

●Regarding PS measurement result

PS measurement result is converted to logarithm 8bit data and is registered as following format

PS\_DATA\_LED1 ( 4Fh ), PS\_DATA\_LED2 ( 50h ), PS\_DATA\_LED3 ( 51h )

7	6	5	4	3	2	1	0
$2^7$	$2^6$	$2^5$	$2^4$	$2^3$	$2^2$	$2^1$	$2^0$

The data seeing above registers are possible to change the irradiance.

Approximation formula is seeing in below.

$$\text{Irradiance} : 10 ^ ( \text{PS\_DATA\_LED} * 0.0197 ) [ \mu\text{W}/\text{cm}^2 ]$$

PS irradiance calculation example

PS\_DATA\_LED1 = " 1000\_0101 "

$$10 ^ ( ( 2^7 + 2^2 + 2^0 ) * 0.0197 ) = 10 ^ ( 133 * 0.0197 ) \div 417 [ \mu\text{W}/\text{cm}^2 ]$$

### ●ALS sensitivity adjustment function

BH1771GLC is possible to change ALS sensitivity. And it is possible to cancel the optical window influence ( difference with / without optical window ) by using this function. Adjustment is done by changing measurement time. For example, when transmission rate of optical window is 50% (measurement result becomes 0.5 times if optical window is set), influence of optical window is ignored by changing sensor sensitivity from default to 2 times.

Sensitivity can be adjusted by ALS\_SENSITIVITY(5Ah). For example, sensitivity 2 times when the value of the register is 2 times, and the measurement time 2 times, too.

The range of adjusting ALS\_SENSITIVITY is below.

		Min.	Typ.	Max.
Adjustable range of ALS_SENSITIVITY	binary	0001_1000 (sensitivity: default * 0.45 )	0011_0101 default	1111_1110 (sensitivity: default * 4.79 )
	decimal	24 (sensitivity: default * 0.45 )	53 default	254 (sensitivity: default * 4.79 )

It is possible to detect 0.21lx by using this function at H-resolution mode.

The below formula is to calculate illuminant per 1 count.

$$\text{Illuminant per 1 count ( lx / count )} = 1 * 53 / X$$

53 : Default value of ALS\_SENSITIVITY register (decimal)

X : ALS\_SENSITIVITY register value (decimal)

Illuminant per 1 count is as following within adjustable range of ALS\_SENSITIVITY.

ALS_SENSITIVITY register value	Illuminant per 1count(lx / count)
0001_1000	2.21
0011_0101	1.00
1111_1110	0.21

Please input the opecode at Power Down state to change ALS\_SENSITIVITY register. There is a possibility of malfunction when the opecode to change ALS\_SENSITIVITY register is input while the illuminant measurement is on-going

In stand alone mode, if ALS measurement time exceeds the value defined ALS\_MEAS\_RATE register, ALS\_MEAS\_RATE register value is ignored. Next measurement is started immediately after one measurement completion.

●Recommended land pattern

Bottom View

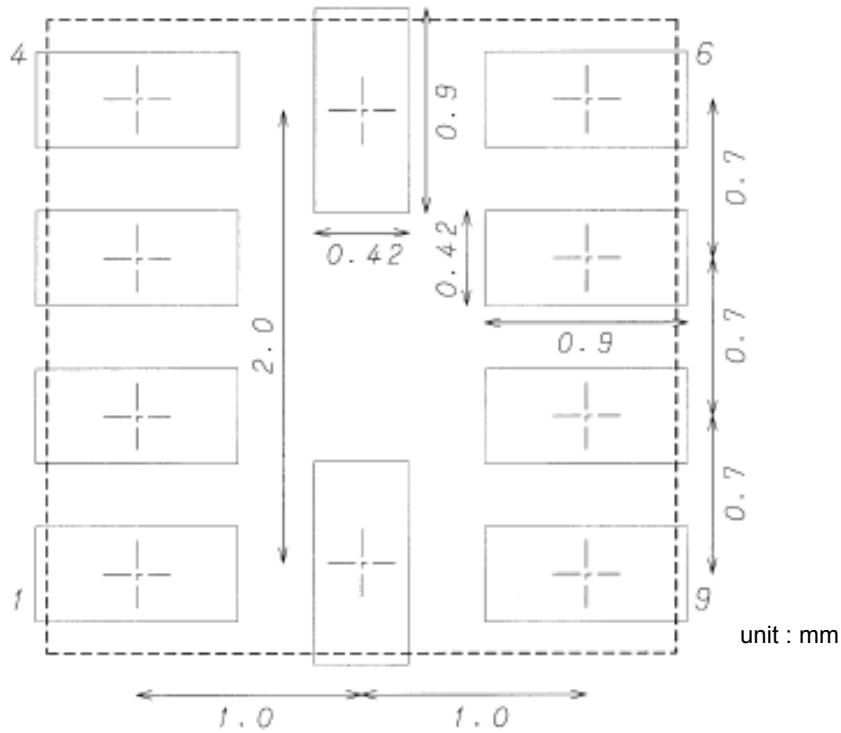

●Optical window design above the device

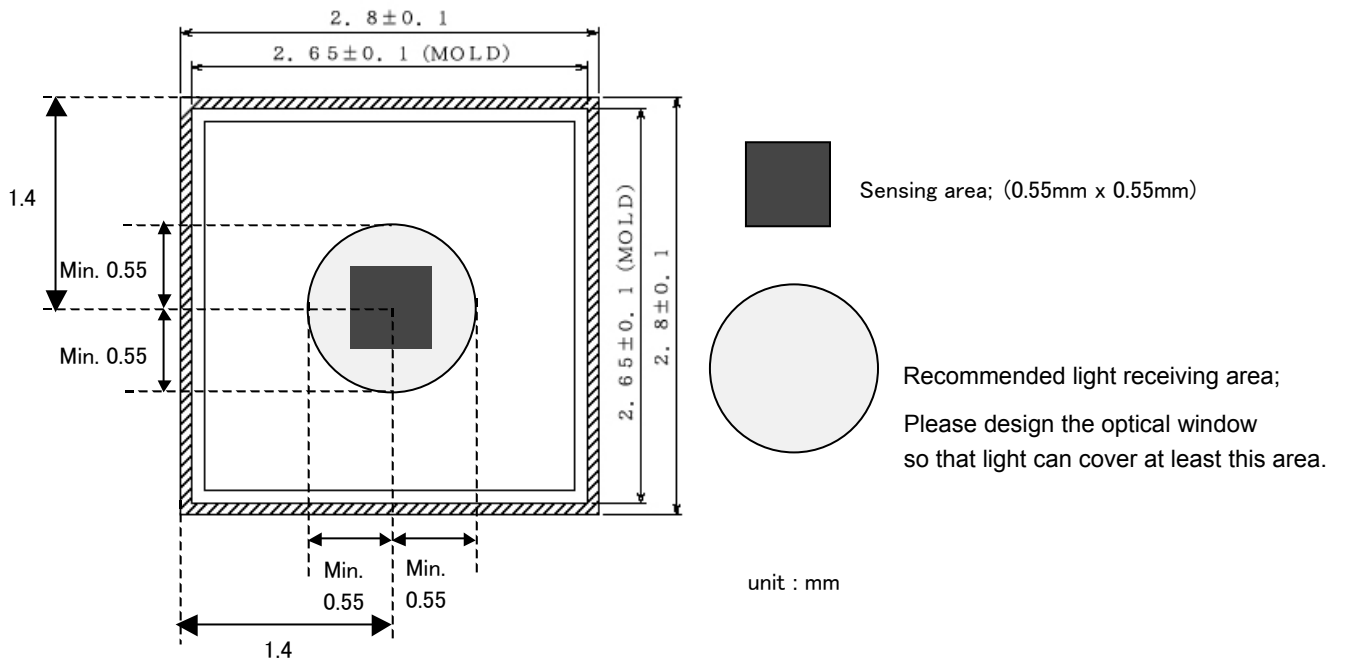

● The method of distinguishing 1pin

There is the following methods of distinguishing 1pin.

- ① Distinguishing by Pad design of top side.  
There are 5 pads in the one side of a top side. There is a space between 2 pads and 3 pads.
- ② Distinguishing by Die pattern.

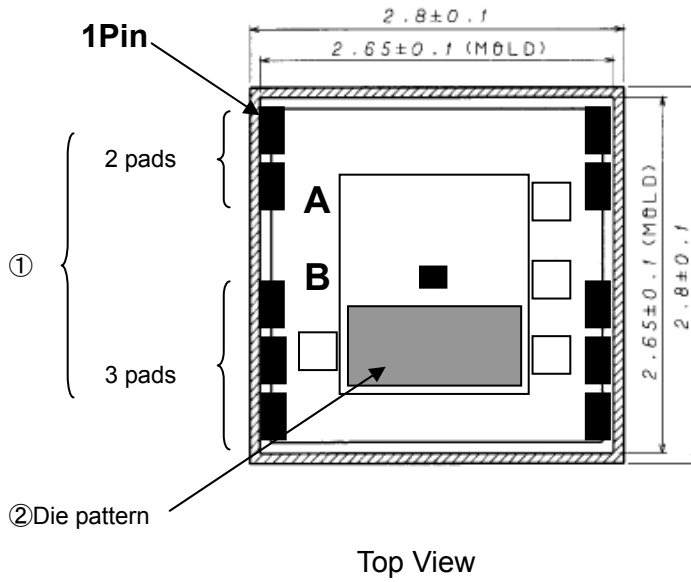

- ③ Distinguishing by Pad design of bottom side.

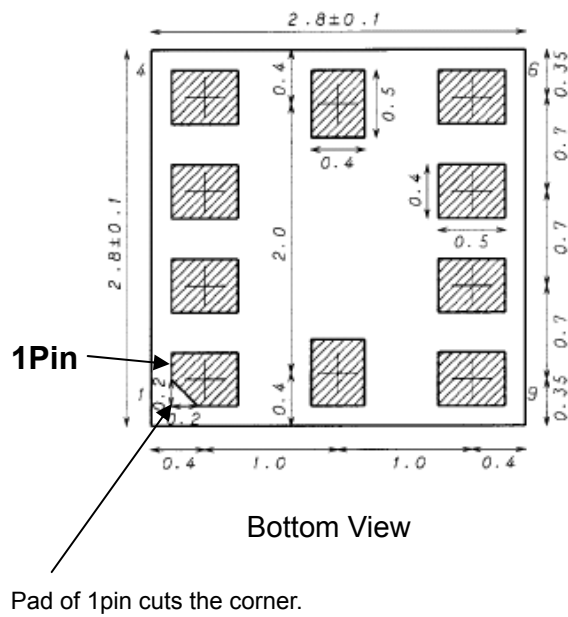

Pad of 1pin cuts the corner.

●Power on reset function

BH1771GLC has power on reset function. By operating this function, all of registers are reset when the power is supplied. Please note followings and design the application.

- ① Power on time :  $t_1$   
BH1771GLC becomes operational after 2ms since VCC voltage crosses 1.9V from being less than 0.4V.
- ② Power off time :  $t_2$   
Before the power is supplied, VCC voltage should be less than 0.4V at least for 1ms.

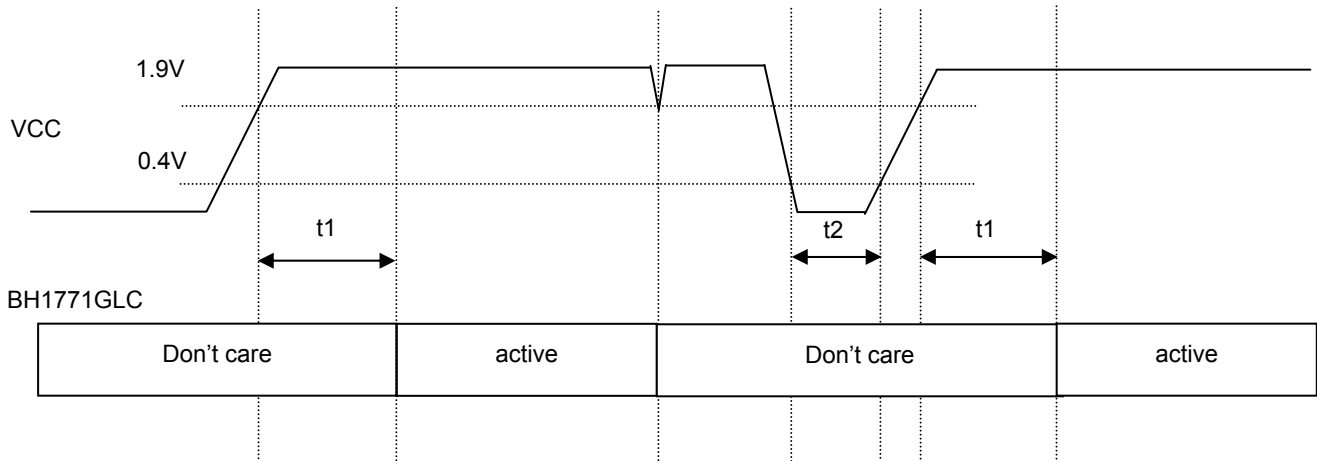

\*"active state" means that BH1771GLC is correctly operational.

INT terminal is high impedance when VCC is supplied.

## ●Cautions on use

## 1) Absolute Maximum Ratings

An excess in the absolute maximum ratings, such as supply voltage (  $V_{ccmax}$ ,  $V_{SDAmax}$ ,  $V_{SCLmax}$ ,  $V_{INTmax}$ ,  $V_{GNDNCmax}$ ,  $V_{LEDmax}$  ), temperature range of operating conditions (  $T_{opr}$  ), etc., can break down devices, thus making impossible to identify breaking mode such as a short circuit or an open circuit. If any special mode exceeding the absolute maximum ratings is assumed, consideration should be given to take physical safety measures including the use of fuses, etc.

## 2) GND voltage

Make setting of the potential of the GND terminal and GND\_LED terminal so that they will be maintained at the minimum in any operating state. Furthermore, check to be sure no terminals are at a potential lower than the GND voltage including an actual electric transient.

## 3) Short circuit between terminals and erroneous mounting

In order to mount ICs on a set PCB, pay thorough attention to the direction and offset of the ICs. Erroneous mounting can break down the ICs. Furthermore, if a short circuit occurs due to foreign matters entering between terminals or between the terminal and the power supply or the GND terminal, the ICs can break down.

## 4) Operation in strong electromagnetic field

Be noted that using ICs in the strong electromagnetic field can malfunction them.

## 5) Inspection with set PCB

On the inspection with the set PCB, if a capacitor is connected to a low-impedance IC terminal, the IC can suffer stress. Therefore, be sure to discharge from the set PCB by each process. Furthermore, in order to mount or dismount the set PCB to/from the jig for the inspection process, be sure to turn OFF the power supply and then mount the set PCB to the jig. After the completion of the inspection, be sure to turn OFF the power supply and then dismount it from the jig. In addition, for protection against static electricity, establish a ground for the assembly process and pay thorough attention to the transportation and the storage of the set PCB.

## 6) Input terminals

In terms of the construction of IC, parasitic elements are inevitably formed in relation to potential. The operation of the parasitic element can cause interference with circuit operation, thus resulting in a malfunction and then breakdown of the input terminal. Therefore, pay thorough attention not to handle the input terminals; such as to apply to the input terminals a voltage lower than the GND respectively, so that any parasitic element will operate. In addition, apply to the input terminals a voltage within the guaranteed value of electrical characteristics.

## 7) Thermal design

Perform thermal design in which there are adequate margins by taking into account the power dissipation (  $P_d$  ) in actual states of use.

## 8) Treatment of package

Dusts or scratch on the photo detector may affect the optical characteristics. Please handle it with care.

## 9) RUSH current

When power is first supplied to the CMOS IC, it is possible that the internal logic may be unstable and rush current may flow instantaneously. Therefore, give special consideration to power coupling capacitance, power wiring, width of GND wiring, and routing of connections.

● Ordering part number

B	H
---	---

Part No.

1	7	7	1
---	---	---	---

Part No.

G	L	C
---	---	---

Package  
GLC: WLGA010V28

E	2
---	---

Packaging and forming specification  
E2: Embossed tape and reel

WLGA010V28

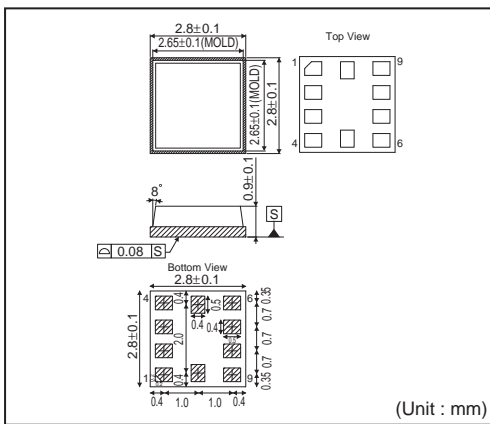

<Tape and Reel information>

Tape	Embossed carrier tape (with dry pack)
Quantity	3000pcs
Direction of feed	E2 (The direction is the 1pin of product is at the upper left when you hold reel on the left hand and you pull out the tape on the right hand )

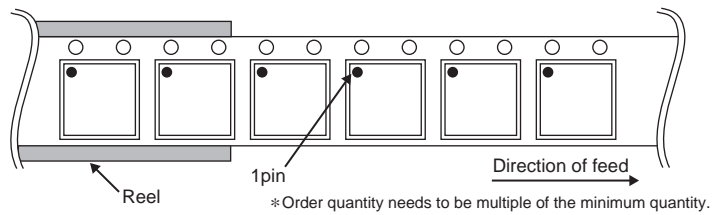



## Notes

No copying or reproduction of this document, in part or in whole, is permitted without the consent of ROHM Co.,Ltd.

The content specified herein is subject to change for improvement without notice.

The content specified herein is for the purpose of introducing ROHM's products (hereinafter "Products"). If you wish to use any such Product, please be sure to refer to the specifications, which can be obtained from ROHM upon request.

Examples of application circuits, circuit constants and any other information contained herein illustrate the standard usage and operations of the Products. The peripheral conditions must be taken into account when designing circuits for mass production.

Great care was taken in ensuring the accuracy of the information specified in this document. However, should you incur any damage arising from any inaccuracy or misprint of such information, ROHM shall bear no responsibility for such damage.

The technical information specified herein is intended only to show the typical functions of and examples of application circuits for the Products. ROHM does not grant you, explicitly or implicitly, any license to use or exercise intellectual property or other rights held by ROHM and other parties. ROHM shall bear no responsibility whatsoever for any dispute arising from the use of such technical information.

The Products specified in this document are intended to be used with general-use electronic equipment or devices (such as audio visual equipment, office-automation equipment, communication devices, electronic appliances and amusement devices).

The Products specified in this document are not designed to be radiation tolerant.

While ROHM always makes efforts to enhance the quality and reliability of its Products, a Product may fail or malfunction for a variety of reasons.

Please be sure to implement in your equipment using the Products safety measures to guard against the possibility of physical injury, fire or any other damage caused in the event of the failure of any Product, such as derating, redundancy, fire control and fail-safe designs. ROHM shall bear no responsibility whatsoever for your use of any Product outside of the prescribed scope or not in accordance with the instruction manual.

The Products are not designed or manufactured to be used with any equipment, device or system which requires an extremely high level of reliability the failure or malfunction of which may result in a direct threat to human life or create a risk of human injury (such as a medical instrument, transportation equipment, aerospace machinery, nuclear-reactor controller, fuel-controller or other safety device). ROHM shall bear no responsibility in any way for use of any of the Products for the above special purposes. If a Product is intended to be used for any such special purpose, please contact a ROHM sales representative before purchasing.

If you intend to export or ship overseas any Product or technology specified herein that may be controlled under the Foreign Exchange and the Foreign Trade Law, you will be required to obtain a license or permit under the Law.



Thank you for your accessing to ROHM product informations.  
More detail product informations and catalogs are available, please contact us.

### ROHM Customer Support System

<http://www.rohm.com/contact/>