

Sound control IC

BH3852S / BH3852FS

The BH3852S and BH3852FS are signal processing ICs designed for volume and tone control in CD radio cassettes and other audio products. They can be used without a microcomputer because they use DC current for control.

●Applications

CD radio cassettes, micro components, car stereos, televisions

●Features

- 1) Can control volume (main volume) and tone (bass, treble).
- 2) Volume is produced by a low-distortion, low-noise VCA, is controlled with DC current, and, due to an internal reference voltage with temperature compensation, can control two channels with a single variable resistor.
- 3) Input amp can be used for gain adjustment, and matrix surround yields powerful sound.

●Absolute maximum ratings (Ta = 25°C)

| Parameter | Symbol | Limits | Unit |
|-----------------------|----------|----------|------|
| Power supply voltage | Vcc | 10.0 | V |
| Power dissipation | BH3852S | 1050*1 | mW |
| | BH3852FS | 800 *2 | |
| Operating temperature | Topr | -40~+85 | °C |
| Storage temperature | Tstg | -55~+125 | °C |

*1 Reduced by 10.5mW for each increase in Ta of 1°C over 25°C.

*2 Reduced by 8mW for each increase in Ta of 1°C over 25°C.

●Recommended operating conditions

| Parameter | Symbol | Min. | Typ. | Max. | Unit |
|----------------------|--------|------|------|------|------|
| Power supply voltage | Vcc | 5.4 | — | 9.5 | V |

● Block diagram

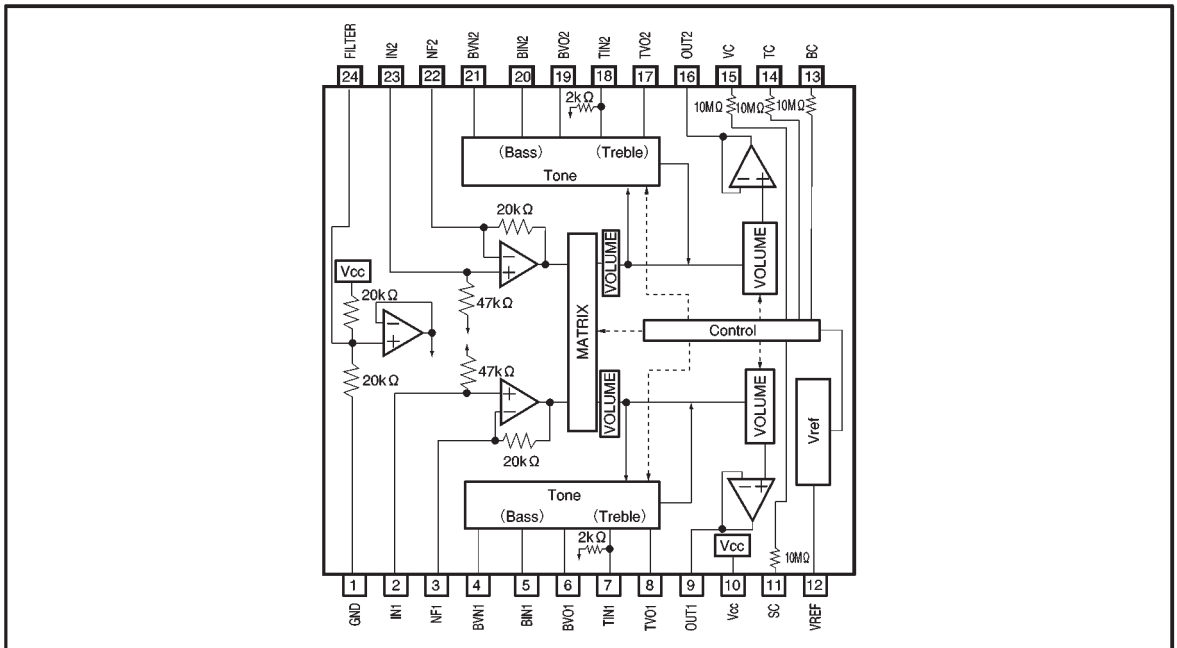

● Pin descriptions

| Pin No. | Pin name | Function | Pin No. | Pin name | Function |
|---------|-----------------|------------------------------------|---------|----------|----------------------------------|
| 1 | GND | Ground | 13 | BC | Bass control pin |
| 2 | IN1 | Channel 1 volume input | 14 | TC | Treble control pin |
| 3 | NF1 | Input-stage amplifier gain setting | 15 | VC | Volume control pin |
| 4 | BVN1 | Channel 1 bass filter | 16 | OUT2 | Channel 2 volume output |
| 5 | BIN1 | Channel 1 bass filter | 17 | TVO2 | Channel 2 treble filter |
| 6 | BVO1 | Channel 1 bass filter | 18 | TIN2 | Channel 2 treble filter |
| 7 | TIN1 | Channel 1 treble filter | 19 | BVO2 | Channel 2 bass filter |
| 8 | TVO1 | Channel 1 treble filter | 20 | BIN2 | Channel 2 bass filter |
| 9 | OUT1 | Channel 1 volume out | 21 | BVN2 | Channel 2 bass filter |
| 10 | V _{cc} | Power supply | 22 | NF2 | Input-stage amplifier gain stage |
| 11 | SC | Surround control pin | 23 | IN2 | Channel 2 volume input |
| 12 | VREF | Reference voltage output | 24 | FILTER | Filter pin |

● Input / output circuits

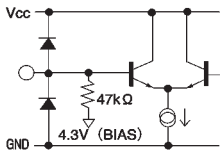
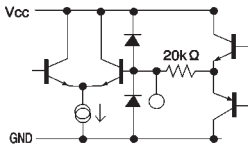
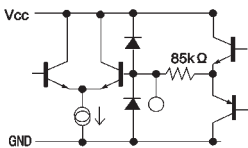
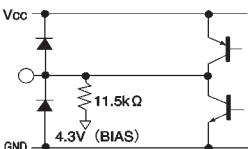
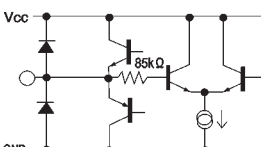
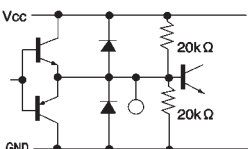
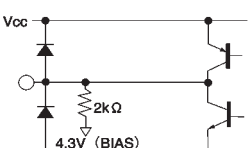
| Symbol | Pin no. | Pin voltage | Equivalent circuit | Pin description |
|--------------|---------------|--------------|---|--|
| IN1 IN2 | 2pin 23pin | 4.3V 4.3V |  | Main volume input pin. Designed for input impedance of 47 kΩ (Typ.) |
| NF1 NF2 | 3pin 22pin | 4.3V 4.3V |  | Pin for adjustment of input amp gain. Approximately +6 dB with connection of 20 kΩ resistance. |
| BVN1 BVN2 | 4pin 21pin | 4.3V 4.3V |  | Pin for low band filter connection. |
| BIN1 BIN2 | 5pin 20pin | 4.3V 4.3V |  | Pin for low band filter connection. |
| BV01 BV02 | 6pin 19pin | 4.3V 4.3V |  | Pin for low band filter connection. |
| FILTER | 24pin | 4.0V |  | Filter input pin. Filter input pin designed to operate at approximately 1/2 Vcc. Please install a capacitor of about 10 μF to the filter pin. Has built-in precharge and discharge circuits. |
| TIN1 TIN2 | 7pin 18pin | 4.3V 4.3V |  | Pin for high band filter connection. |

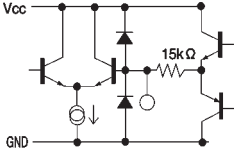
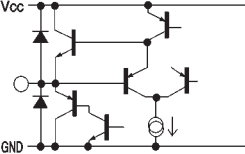
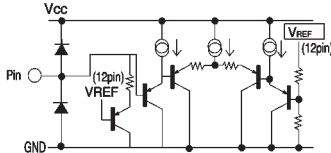
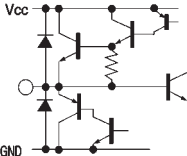
| Symbol | Pin no. | Pin voltage | Equivalent circuit | Pin description |
|----------------------|----------------------------------|--------------|--|---|
| TV01 TV02 | 8pin 17pin | 4.3V 4.3V |  | Pin for high band filter connection. |
| OUT1 OUT2 | 9pin 16pin | 4.0V 4.0V |  | Main volume output pin. OUT1 is the volume output for ch1. OUT2 is the volume output for ch2. |
| SC BC TC VC | 11pin 13pin 14pin 15pin | — |  | VC: Volume pin TC: Treble pin BC: Bass pin SC: Surround pin |
| VREF | 12pin | 3.8V |  | Regulator output pin. Output requires capacitor for stopping oscillation. Output pin has built-in precharge and discharge circuits, so there is no problem when turned on or off, even with a large capacitor. |
| Vcc | 10pin | 8V | Power supply voltage pin. | |
| GND | 1pin | 0V | GND pin. Connected to IC board. | |

Note: All figures for pin voltage assume a power supply voltage (Vcc) of 8V.

- Electrical characteristics (unless otherwise noted, $T_a = 25^\circ\text{C}$, $V_{CC} = 8\text{V}$, $f = 1\text{kHz}$, $\text{BW} = 20 \sim 20\text{kHz}$,
 $\text{VOL} = \text{Max.}$, $\text{TONE} = \text{ALL FLAT}$, $R_g = 600\Omega$, $R_L = 10\text{k}\Omega$, $\text{INPUT_AMP_GAIN} = 0\text{dB}$)

| Parameter | Symbol | Min. | Typ. | Max. | Unit | Conditions |
|--|------------|-------|-------|------|---------------|---|
| Quiescent current | I_Q | 8 | 17 | 25 | mA | No signal |
| Maximum input | V_{im} | 1.8 | 2.0 | — | V_{rms} | THD=1%, VOL=-20dB(ATT) |
| Maximum output | V_{om} | 1.8 | 2.0 | — | V_{rms} | THD=1% |
| Voltage gain | G_V | -3.0 | -1.0 | 1.0 | dB | $V_{IN}=1V_{rms}$ |
| Maximum attenuation | ATT | 90 | 110 | — | dB | $V_O=1V_{rms}$ |
| Crosstalk | V_{CT} | 57 | 67 | — | dB | $V_O=1V_{rms}$, BPF=400Hz~30kHz |
| Low range control width | V_{Bmax} | 12 | 15 | 18 | dB | 75Hz, $V_{IN}=100mV_{rms}$ |
| | V_{Bmin} | -18 | -15 | -12 | dB | 75Hz, $V_{IN}=100mV_{rms}$ |
| High range control width | V_{Tmax} | 12 | 15 | 18 | dB | 10kHz, $V_{IN}=100mV_{rms}$ |
| | V_{Tmin} | -18 | -15 | -12 | dB | 10kHz, $V_{IN}=100mV_{rms}$ |
| Mute attenuation | V_{MT} | 90 | 110 | — | dB | $V_O=1V_{rms}$ * |
| Total Harmonic distortion | THD | — | 0.03 | 0.1 | % | $V_O=0.3V_{rms}$, BPF=400Hz~30kHz |
| Output noise voltage | V_{NO1} | — | 25 | 35 | μV_{rms} | No signal VOL=MAX, $R_g=0$ * |
| Output noise voltage during full boost | V_{NO2} | — | 73 | 113 | μV_{rms} | No signal TONE=ALL MAX, VOL=MAX, $R_g=0$ * |
| Residual output noise voltage | V_{MNO} | — | 2 | 10 | μV_{rms} | No signal VOL=-∞, $R_g=0$ * |
| Reference power supply output voltage | V_{REF} | 3.54 | 3.84 | 4.14 | V | $I_{REF}=3\text{mA}$ |
| Reference power supply output current capacity | I_{REF} | 3.0 | 10 | — | mA | V_{REF} voltage drop of 0.1V or less |
| Channel balance | G_{CB} | -2.0 | 0 | 2.0 | dB | ch1 taken as the standard for measurements. |
| Volume attenuation (-10 dB) | ATT10 | -12.6 | -10.6 | -8.6 | dB | $V_{IN}=0\text{dBV}$, $V_C=0.665XV_{REF}$ |
| VC port discharge current | IVC | — | 0.2 | 0.4 | μA | Pin 15 discharge current |
| TC port discharge current | ITC | — | 0.2 | 0.4 | μA | Pin 14th discharge current |
| BC port discharge current | IBC | — | 0.2 | 0.4 | μA | Pin 13th discharge current |
| SC port discharge current | ISC | — | 0.2 | 0.4 | μA | Pin 11th discharge current |

* Measurement performed using Matsushita Communication Industrial VP-9690A DIN AUDIO filter (average value wave detection, effective value display).

◎ Not designed for radiation resistance.

● Measurement circuit

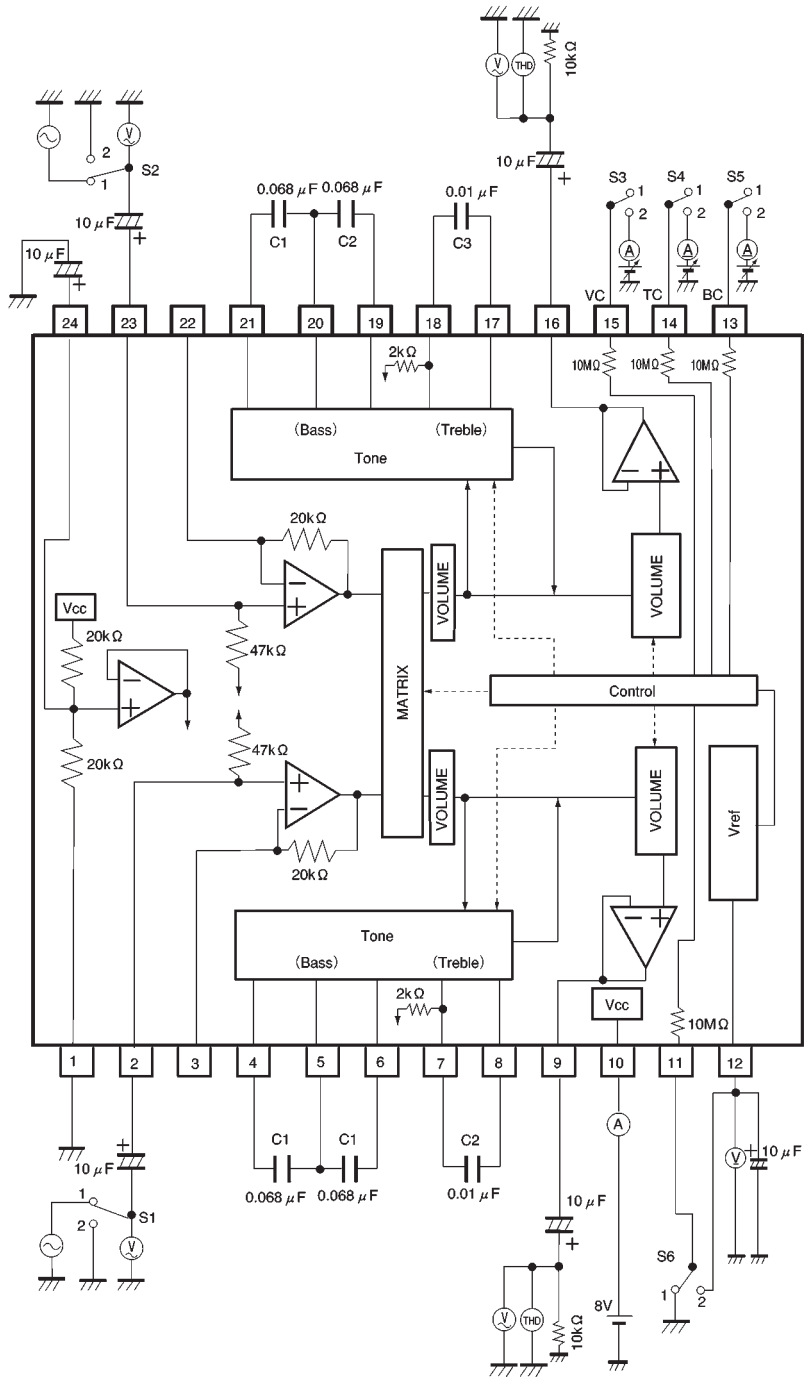

Fig. 1

● Application example

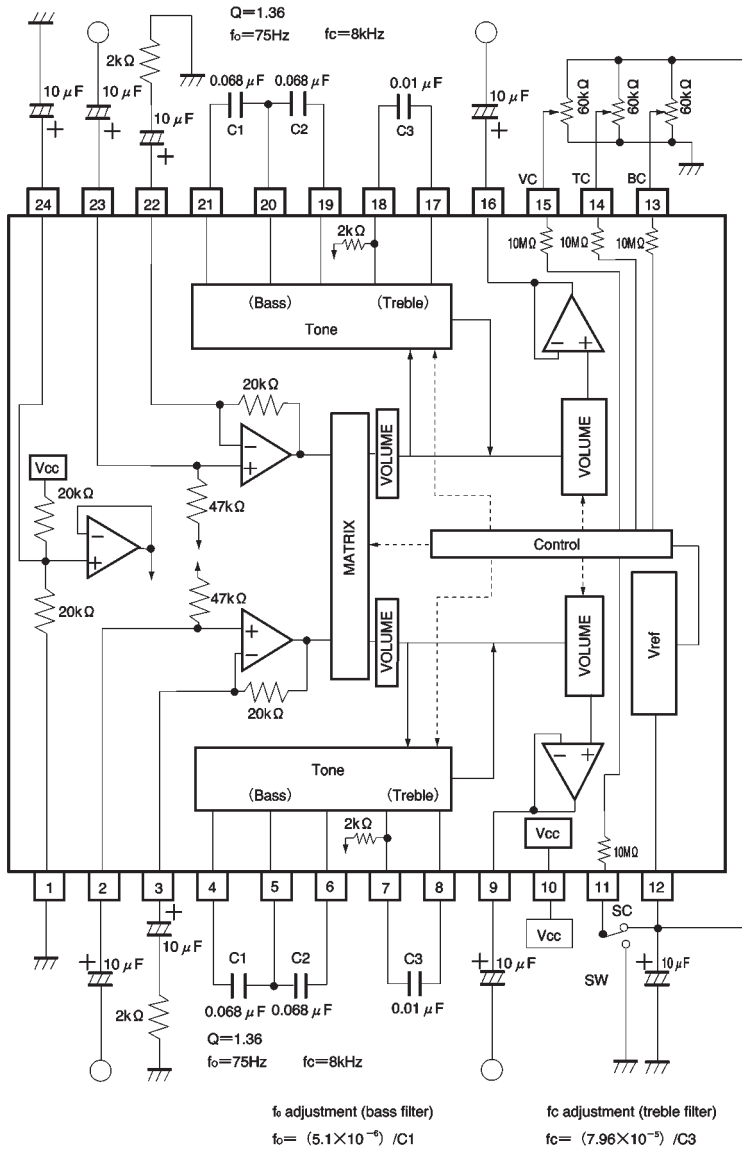

Fig. 2

● Operation notes

(1) Operating power supply voltage range

As long as the operating power supply voltage range and ambient temperature are kept within the specified range, the basic circuits are guaranteed to function, but be sure to check the constants as well as the element settings, voltage settings, and temperature settings. Also, volume curves sometimes depart from target values when there is a combination of low temperature and reduced power.

(2) Primary amp

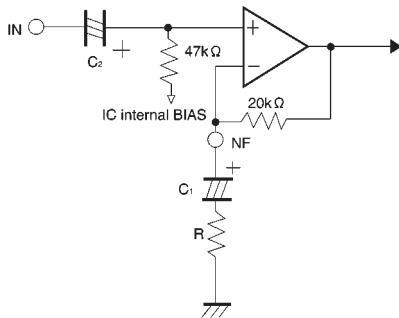

- The input impedance is 47kΩ.
- A buffer if R and C₁ are not present.
- The gain can be set by R and the 20kΩ.

$$G_{VC} = (R + 20k\Omega) / R$$

Note: Set C₂ (input coupling) and C₁ (used to set the gain) depending on the frequency band used.

(3) Bass filter

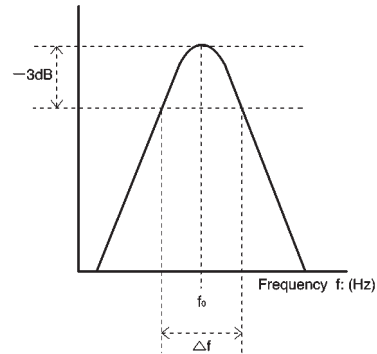
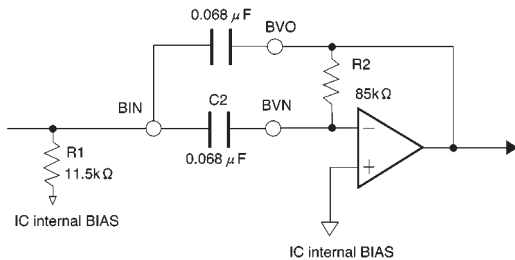

- The BPF is composed of a multifeedback active filter.

f₀ can be varied according to the value of C.

(theoretical equation)

$$f_0 = \frac{1}{2\pi} \times \left(\frac{1}{R_1 R_2 C_1 C_2} \right)^{\frac{1}{2}}$$

$$Q \doteq \left[\left(\frac{R_1}{R_2 C_1 C_2} \right)^{\frac{1}{2}} \times (C_1 + C_2) \right]^{-1}$$

$$G = \frac{R_2}{5k\Omega} \times \left(1 + \frac{C_1}{C_2} \right)^{-1}$$

Note: Filter gain is calculated using the equation on the left. Total output gain is the sum of the gain for each of the internal circuits.

(When R₁ = 11.5kΩ, R₂ = 85kΩ, C₁ = C₂ = C)

$$f_0 = \frac{5.1 \times 10^{-6}}{C} \quad Q = 1.36 \quad G = 8.5$$

(4) Treble filter

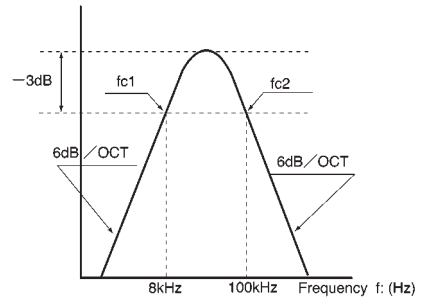
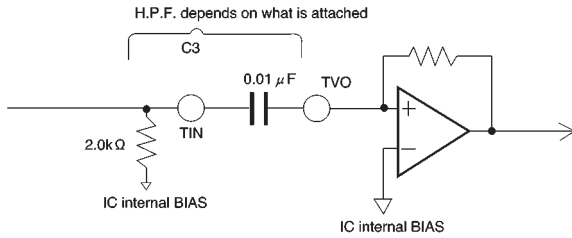

- Cutoff frequency (fc1) for the bypass filter can be changed using the attached C₃.

$$f_{c1} = \frac{1}{2\pi \times C_3 \times 2k\Omega}$$

The f_{c1} for the recommended constant is approximately 8 kHz.

- f_{c2} is determined by the band of the built-in amp. f_{c2} is approximately 100 kHz.

Tone control is designed to yield a variation of ±15dB (Typ.) when the frequency to be boosted or cut is at the peak or bottom of the filter frequency characteristic, so please take the frequency characteristic into consideration in designing the filter.

(5) Signal level setting

The following figure represents the standard setting for the BH3852FS / BH3852S.

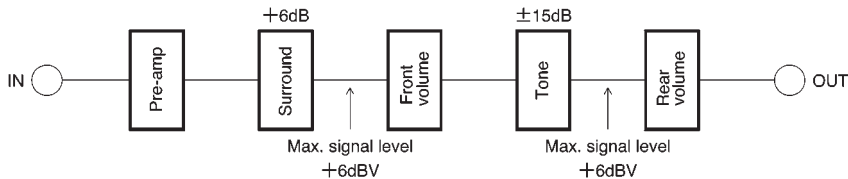

★As indicated above, if the front volume and rear volume input level are set so as not to exceed +6dBV (2V_{rms}), the pre-amp gain setting can be used to improve the S/N ratio.

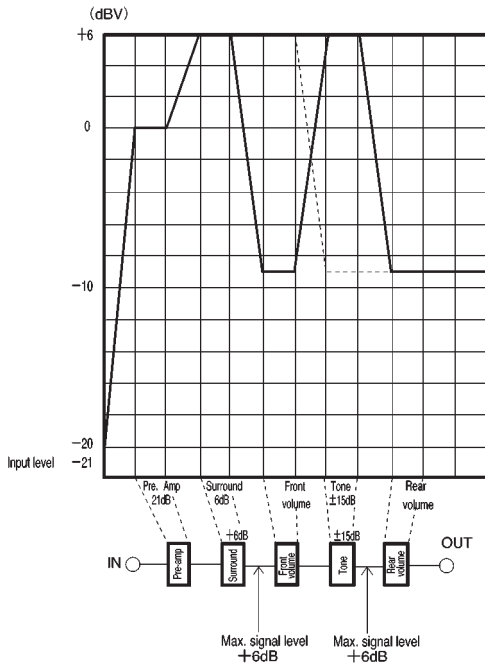

The figure on the left is a level diagram.
 Solid line: Input level during tone boost
 Dotted line: Input level during tone cut

(6) Matrix surround

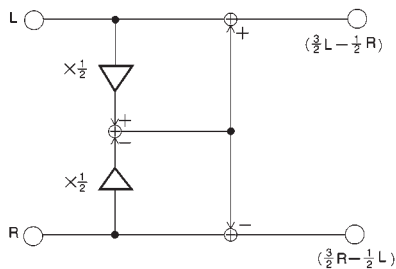

© The structure of the matrix surround is as shown in the figure above. Use the equations shown in the figure to calculate gain.

| | |
|---------------------|-------|
| In-phase gain | 0dB |
| Negative-phase gain | 3.5dB |

(Negative-phase gain only occurs when input is carried out at a single channel.)

(7) DC control

It is recommended that DC control of the VC, TC, BC, and SC pins be performed by voltage delivered in variable volume from the V_{ref} pin (12th pin). When using variable volume, take the discharge current of each pin into account in determining its settings.

Note: The voltage range for DC control is 0 (V) to V_{ref} (V). Be sure not to apply voltage greater than V_{ref} (V) to any pin.

(8) GND

If several capacitors with good high-frequency characteristics are connected in parallel to the 12th-pin capacitor, the characteristics will be improved with respect to static electricity noise. (Recommended: ceramic capacitors of 0.001 μ F to 0.1 μ F)

●Electrical characteristic curves

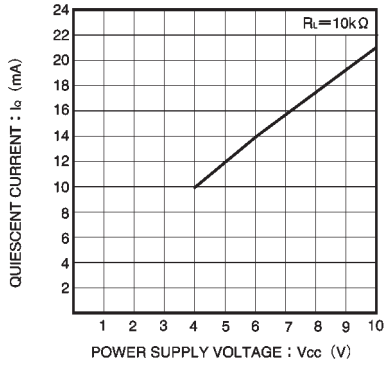

Fig. 3 Quiescent curve vs. power supply voltage

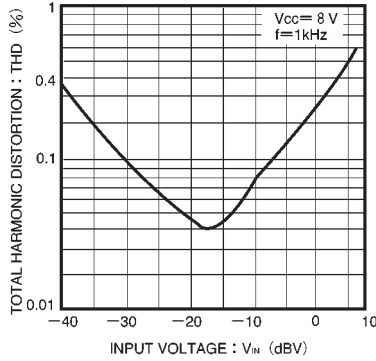

Fig. 4 Harmonic distortion vs. input voltage

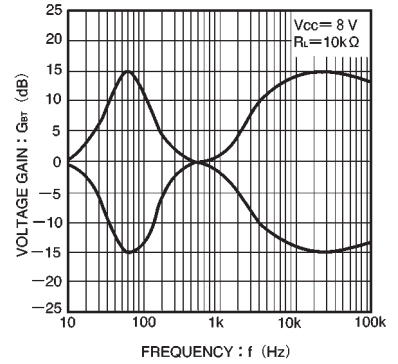

Fig. 5 Output gain vs. frequency

●External dimensions (Units: mm)

