

1 . Features

- Wide 4 : 1 Input Range
- Low Ripple And Noise
- Input / Output Isolation 1.5K Vdc Or 3K Vdc
- 100% Burn-In
- Input - Filter
- Custom Design Available
- Net Weight: 12 g / 17 g Typical
- RoHS Converter Certified By SGS

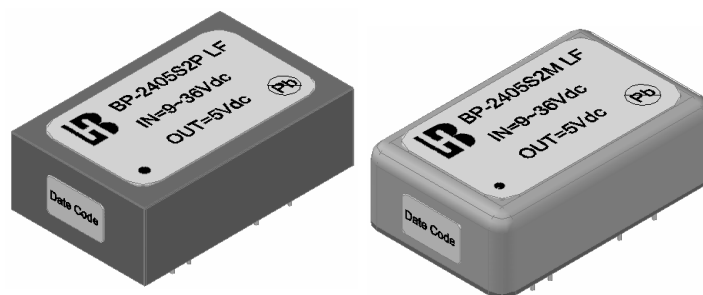

2 . Single Output Selection Guide

(Specifications typical at Ta= +25 , Nominal input voltage, Rated output current unless otherwise noted)

Model No.	Input Voltage (Vdc)	Output Voltage (Vdc)	Output Current (mA) Max	Input Current @No Load (mA) Typ.	Input Current @Max. Load (mA) Typ.	Output Ripple (mV) Max.	Load Regulation (%)Max.	Efficiency (%)Typ.
1) 2 W Single Output Series								
BP-2405S2 LF	9~36	5	400	9	113	50	± 0.5	74
BP-2412S2 LF		12	167	20	110	100	± 0.5	76
BP-2415S2 LF		15	134	21	107	120	± 0.5	78
BP-4805S2 LF	18~75	5	400	10	58	50	± 0.5	72
BP-4812S2 LF		12	167	12	56	100	± 0.5	75
BP-4815S2 LF		15	134	13	55	120	± 0.5	76
2) 4 W Single Output Series								
BP-2405S4 LF	9~36	5	800	19	219	50	± 0.5	76
BP-2412S4 LF		12	333	20	213	100	± 0.5	78
BP-2415S4 LF		15	267	22	209	100	± 0.5	80
BP-4805S4 LF	18~75	5	800	10	105	50	± 0.5	79
BP-4812S4 LF		12	333	13	104	100	± 0.5	80
BP-4815S4 LF		15	267	15	101	120	± 0.5	83
3) 6 W Single Output Series								
BP-2405S6 LF	9~36	5	1200	25	321	50	± 0.5	78
BP-2412S6 LF		12	500	27	313	100	± 0.5	80
BP-2415S6 LF		15	400	27	309	120	± 0.5	81
BP-4805S6 LF	18~75	5	1200	15	158	50	± 0.5	79
BP-4812S6 LF		12	500	17	154	100	± 0.5	81
BP-4815S6 LF		15	400	17	152	120	± 0.5	82

4) 2 W Dual Output Series								
BP-2405D2 LF	9~36	± 5	± 200	19	116	50	± 2	72
BP-2412D2 LF		± 12	± 83	20	111	100	± 2	75
BP-2415D2 LF		± 15	± 67	21	112	120	± 2	75
BP-4805D2 LF	18~75	± 5	± 200	10	56	50	± 2	74
BP-4812D2 LF		± 12	± 83	12	55	100	± 2	75
BP-4815D2 LF		± 15	± 67	13	55	120	± 2	76
5) 4 W Dual Output Series								
BP-2405D4 LF	9~36	± 5	± 400	25	214	50	± 2	78
BP-2412D4 LF		± 12	± 167	27	209	100	± 2	80
BP-2415D4 LF		± 15	± 133	28	208	120	± 2	80
BP-4805D4 LF	18~75	± 5	± 400	18	105	50	± 2	79
BP-4812D4 LF		± 12	± 167	20	104	100	± 2	80
BP-4815D4 LF		± 15	± 133	20	104	120	± 2	80
6) 6 W Dual Output Series								
BP-2405D6 LF	9~36	± 5	± 600	25	325	50	± 2	77
BP-2412D6 LF		± 12	± 250	27	313	100	± 2	80
BP-2415D6 LF		± 15	± 200	27	313	120	± 2	80
BP-4805D6 LF	18~75	± 5	± 600	18	160	50	± 2	78
BP-4812D6 LF		± 12	± 250	20	156	100	± 2	80
BP-4815D6 LF		± 15	± 200	20	156	120	± 2	80

Notes :

1. Load regulation is for output current change from 0% to 100% Max. Load.

3 . Absolute Maximum Ratings

(Exceeding these values may damage the module. These are not continuous operating ratings)

Parameter	Condition	Min.	Typ.	Max.	Unit
Input Absolute Voltage Range	24V Input Model	-0.7	24	45	Vdc
	48V Input Model	-0.7	48	90	
Output Short Circuit Duration	Nominal Input Range	Indefinite & Auto-Restart			
Reverse Polarity Input Current Limit	---	---	---	1	A
Operation Temperature (Ambient Temperature)	Output Full Load	-25	---	+71	
Storage Temperature		-55	---	+105	



4 . Nominal Input/Output Electrical Specifications

(Specifications typical at Ta= +25 ,Nominal input voltage, Rated output current unless otherwise noted)

Parameter	Condition	Min.	Typ.	Max.	Unit
Input Voltage Range	24V Input Model	9	24	36	Vdc
	48V Input Model	18	48	75	
Line Regulation	Output Full Load	---	---	± 0.5	%
Load Regulation	Single Output Model	---	---	± 0.5	
	Dual Output Model	---	---	± 2	
Output Voltage Accuracy	Nominal Input	---	± 1.0	± 2.0	
Output Voltage Balance	Dual Output At Same Load	---	---	± 1.0	
Switching Frequency	Nominal Input	---	250	---	KHz
Temperature Coefficient		---	± 0.01	± 0.02	% /
Isolation Voltage	Standard Series	1500	---	---	Vdc
	High Isolation Series	3000	---	---	
Isolation Resistance	500 Vdc	1000	---	---	M
Isolation Capacitance	1KHz / 250mV rms	---	350	---	pF

5 . General Specification

Parameter	Specification	Condition
Isolation Voltage	1500/3000Vdc	Test Duration 60 Seconds / 0.5 mA
Isolation Resistance	1000 M Min.	@ 500 Vdc
Operating Temperature (1)	-25 ~ +71	@ Ambient Temperature With Natural Convection
Operating Temperature (2)	-25 ~ +95	@ Case Surface Temperature
Storage Temperature	-55 ~ +105	---
Humidity	Up To 90 %	---
Cooling	Free Air Convection	---
Case Type	Plastic, Metal	---



6 . Ordering Information

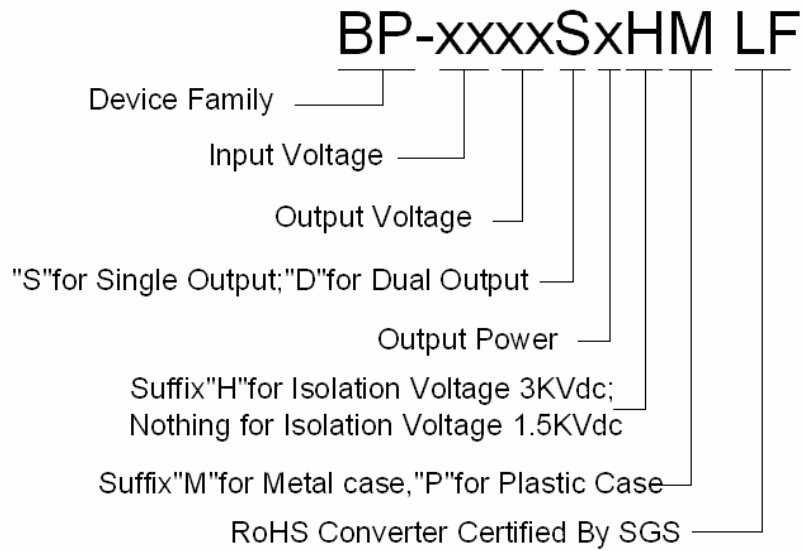

7 . Power Derating Curve

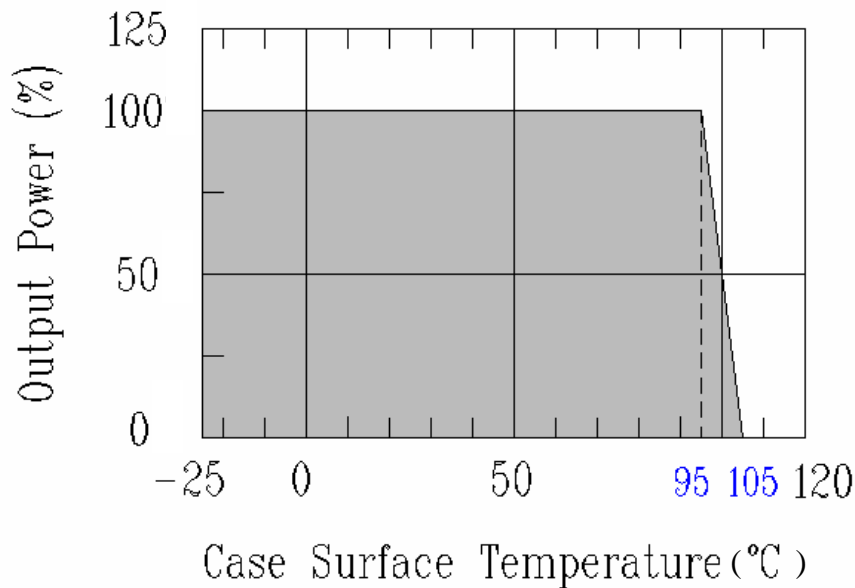

8 . Efficiency & Output Load Chart

Vout= 5 Vdc

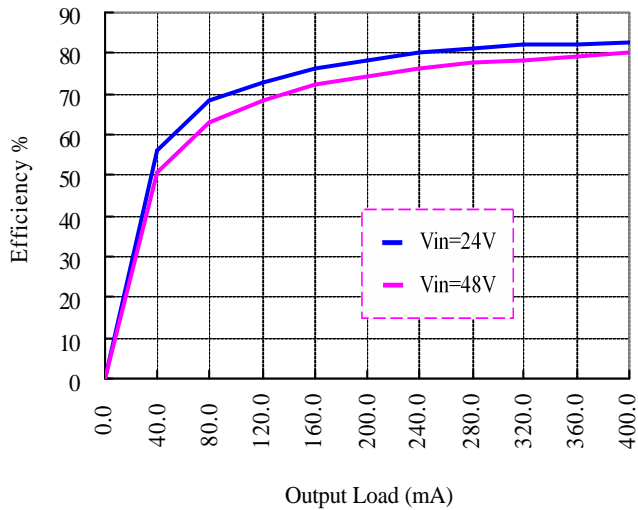

Vout= 12 Vdc

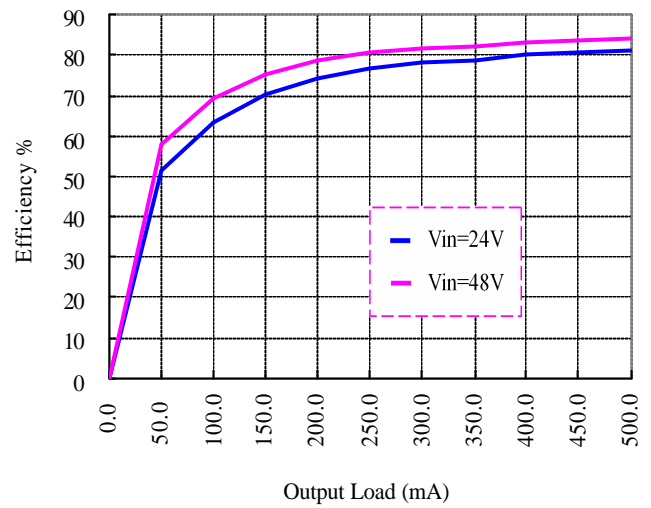

Vout= 15 Vdc

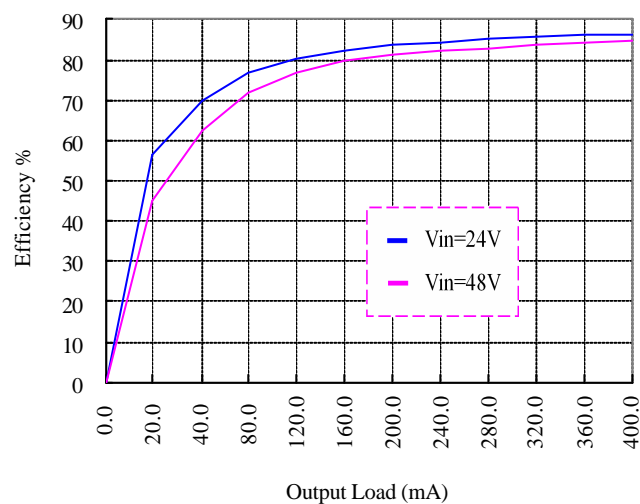

9 . Mechanical Dimension

Metal Case Model

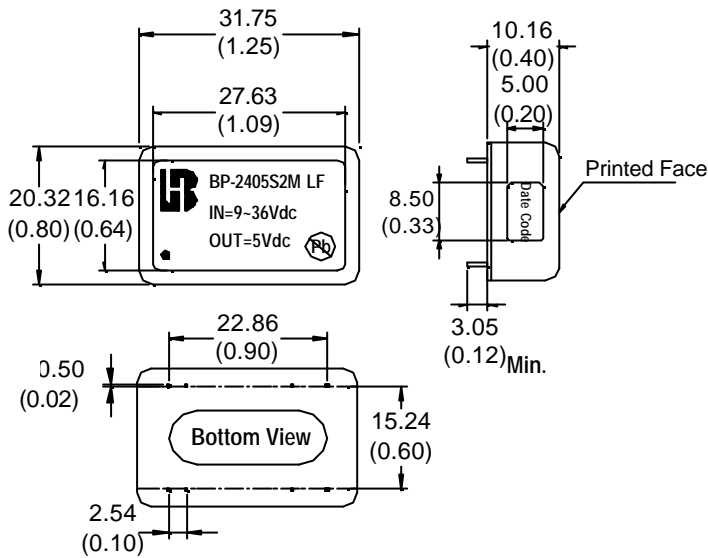

Pin	Single Output	Pin	
1	No Pin	24	
2	-Vin	23	
3	+Vin	22	
4		21	
5		20	
6	No Pin	19	
7		18	
8		17	
9	N.C.	-Vo	16
10	No Pin	15	
11	N.C.	+Vo	14
12	No Pin	13	

Pin	Dual Output		Pin
1	No Pin	No Pin	24
2	-Vin	+Vin	23
3	-Vin	+Vin	22
4			21
5			20
6	No Pin	No Pin	19
7			18
8			17
9	Common	Common	16
10	No Pin	No Pin	15
11	-Vo	+Vo	14
12	No Pin	No Pin	13

Units : mm (inch)
Tolerance : 0.xx ± 0.25 (0.xx ± 0.01)

Plastic Case Model

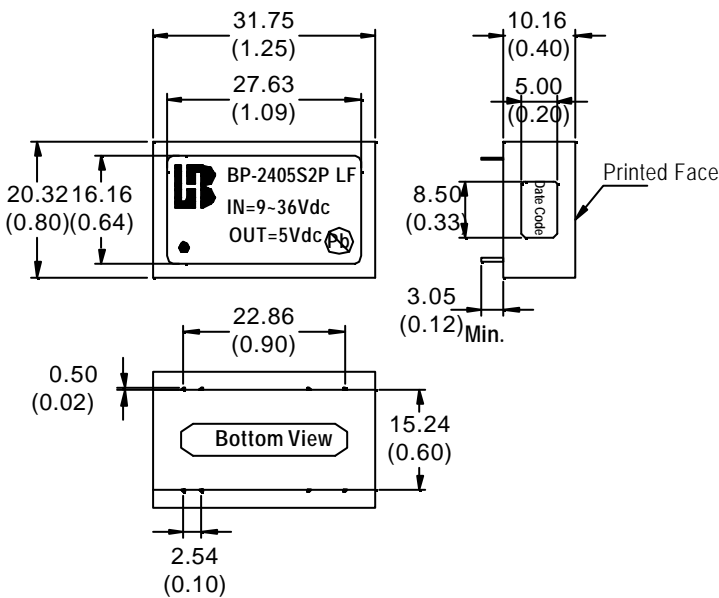

Pin	Single Output	Pin	
1	No Pin	24	
2	-Vin	23	
3	+Vin	22	
4		21	
5		20	
6	No Pin	19	
7		18	
8		17	
9	N.C.	-Vo	16
10	No Pin	15	
11	N.C.	+Vo	14
12	No Pin	13	

Pin	Dual Output		Pin
1	No Pin	No Pin	24
2	-Vin	+Vin	23
3	-Vin	+Vin	22
4			21
5			20
6	No Pin	No Pin	19
7			18
8			17
9	Common	Common	16
10	No Pin	No Pin	15
11	-Vo	+Vo	14
12	No Pin	No Pin	13

Units : mm (inch)
Tolerance : 0.xx ± 0.25 (0.xx ± 0.01)

10 . Recommended Footprint Details

Metal Case Model

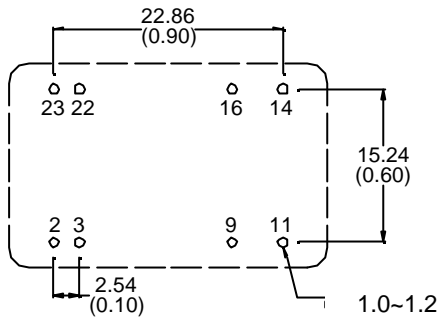

Plastic Case Model

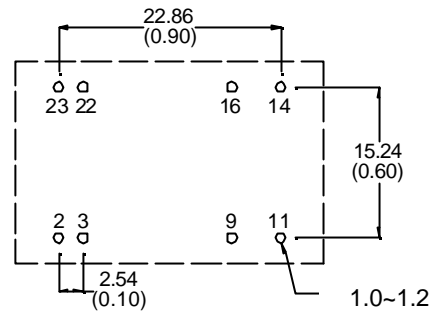

Units : mm (inch)
Tolerance : 0.xx ± 0.25 (0.xx ± 0.01)

11 . Package

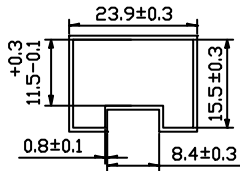

TUBE MECHANICAL DIMENSION

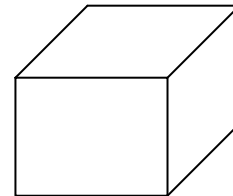
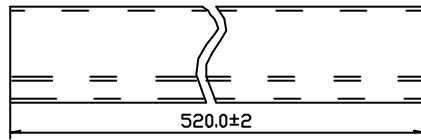

INNER CARTON: 565*115*117

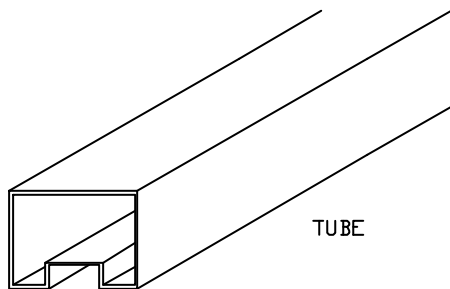

TUBE

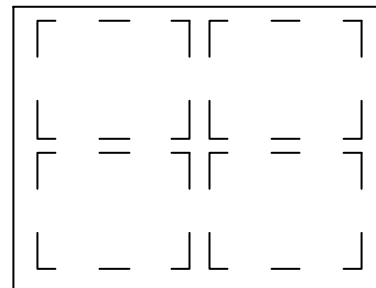

EXPORT CARTON: 580*255*265

1. TUBE=15PCS
2. INNER CARTON=25 TUBE=25*15=375PCS
3. EXPORT CARTON=4 INNER CARTON=4*375=1500PCS