

# Silicon NPN Phototransistor

## Description

BPW85 is a high speed and high sensitive silicon NPN epitaxial planar phototransistor in a standard T-1 ( $\varnothing$  3 mm) plastic package. Due to its waterclear epoxy the device is sensitive to visible and near infrared radiation.

The viewing angle of  $\pm 25^\circ$  makes it insensible to ambient straylight.

## Features

- Fast response times
- High photo sensitivity
- Standard T-1 ( $\varnothing$  3 mm ) clear plastic package
- Axial terminals
- Angle of half sensitivity  $\varphi = \pm 25^\circ$
- Suitable for visible and near infrared radiation
- Selected into sensitivity groups

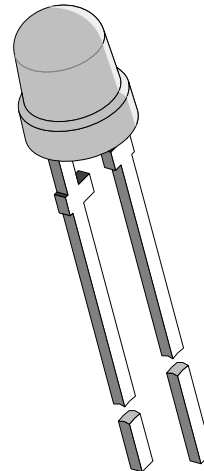

94 8396

## Applications

Detector in electronic control and drive circuits

## Absolute Maximum Ratings

$T_{amb} = 25^\circ\text{C}$

Parameter	Test Conditions	Symbol	Value	Unit
Collector Emitter Voltage		$V_{CEO}$	70	V
Emitter Collector Voltage		$V_{ECO}$	5	V
Collector Current		$I_C$	50	mA
Peak Collector Current	$t_p/T = 0.5, t_p \leq 10 \text{ ms}$	$I_{CM}$	100	mA
Total Power Dissipation	$T_{amb} \leq 55^\circ\text{C}$	$P_{tot}$	100	mW
Junction Temperature		$T_j$	100	$^\circ\text{C}$
Storage Temperature Range		$T_{stg}$	-55...+100	$^\circ\text{C}$
Soldering Temperature	$t \leq 3 \text{ s}, 2 \text{ mm from case}$	$T_{sd}$	260	$^\circ\text{C}$
Thermal Resistance Junction/Ambient		$R_{thJA}$	450	K/W

### Basic Characteristics

$T_{amb} = 25^{\circ}\text{C}$

Parameter	Test Conditions	Symbol	Min	Typ	Max	Unit
Collector Emitter Breakdown Voltage	$I_C = 1\text{ mA}$	$V_{(BR)CE}$ $O$	70			V
Collector Dark Current	$V_{CE} = 20\text{ V}, E = 0$	$I_{CEO}$		1	200	nA
Collector Emitter Capacitance	$V_{CE} = 5\text{ V}, f = 1\text{ MHz}, E = 0$	$C_{CEO}$		3		pF
Angle of Half Sensitivity		$\phi$		$\pm 25$		deg
Wavelength of Peak Sensitivity		$\lambda_p$		850		nm
Range of Spectral Bandwidth		$\lambda_{0.5}$		620...980		nm
Collector Emitter Saturation Voltage	$E_e = 1\text{ mW/cm}^2$ , $\lambda = 950\text{ nm}, I_C = 0.1\text{ mA}$	$V_{CEsat}$			0.3	V
Turn-On Time	$V_S = 5\text{ V}, I_C = 5\text{ mA}$ , $R_L = 100\ \Omega$	$t_{on}$		2.0		$\mu\text{s}$
Turn-Off Time	$V_S = 5\text{ V}, I_C = 5\text{ mA}$ , $R_L = 100\ \Omega$	$t_{off}$		2.3		$\mu\text{s}$
Cut-Off Frequency	$V_S = 5\text{ V}, I_C = 5\text{ mA}$ , $R_L = 100\ \Omega$	$f_c$		180		kHz

### Type Dedicated Characteristics

$T_{amb} = 25^{\circ}\text{C}$

Parameter	Test Conditions	Type	Symbol	Min	Typ	Max	Unit
Collector Light Current	$E_e = 1\text{ mW/cm}^2$ , $\lambda = 950\text{ nm}, V_{CE} = 5\text{ V}$	BPW85A	$I_{ca}$	0.8	1.5	2.5	mA
		BPW85B	$I_{ca}$	1.5	2.5	4.0	mA
		BPW85C	$I_{ca}$	3.0	5.0	8.0	mA

### Typical Characteristics ( $T_{amb} = 25^{\circ}\text{C}$ unless otherwise specified)

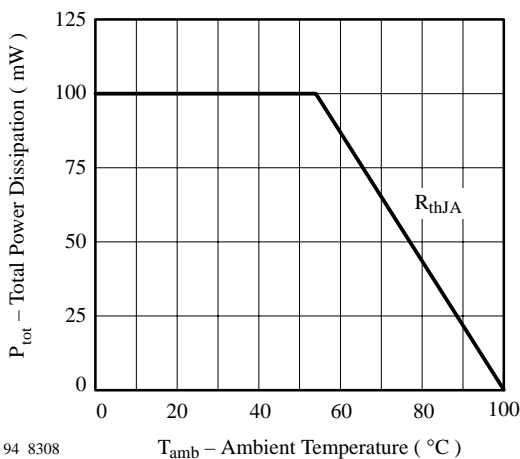

Figure 1. Total Power Dissipation vs. Ambient Temperature

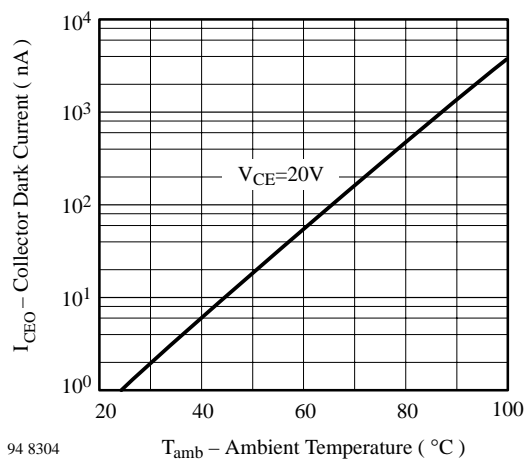
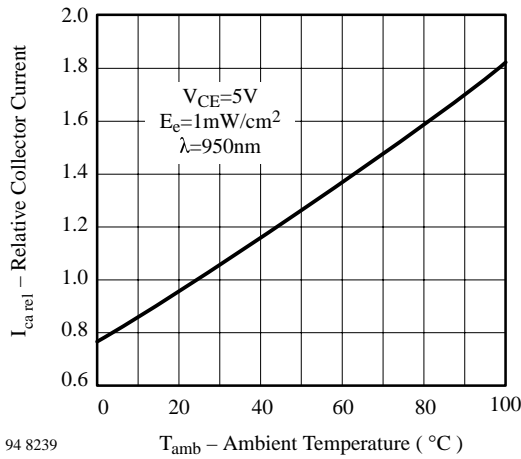
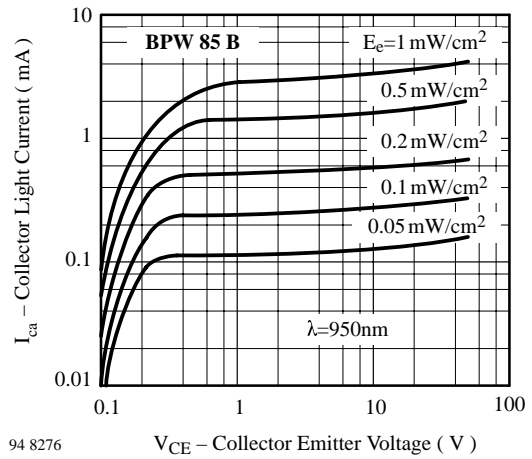

Figure 2. Collector Dark Current vs. Ambient Temperature



94 8239

Figure 3. Relative Collector Current vs. Ambient Temperature



94 8276

Figure 6. Collector Light Current vs. Collector Emitter Voltage

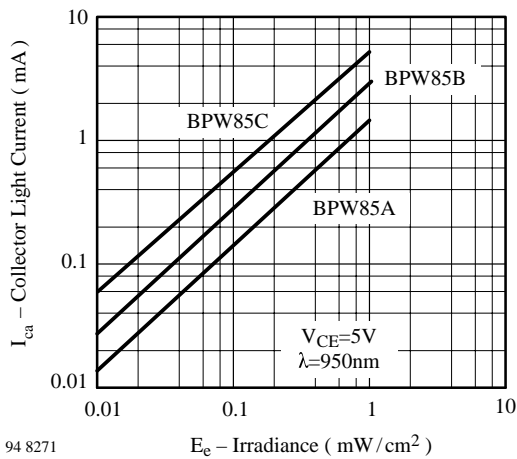

94 8271

Figure 4. Collector Light Current vs. Irradiance

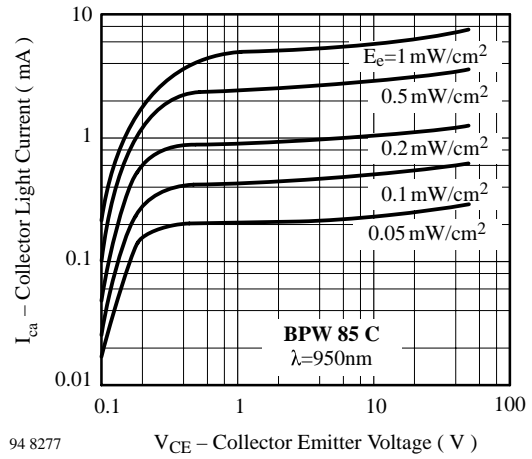

94 8277

Figure 7. Collector Light Current vs. Collector Emitter Voltage

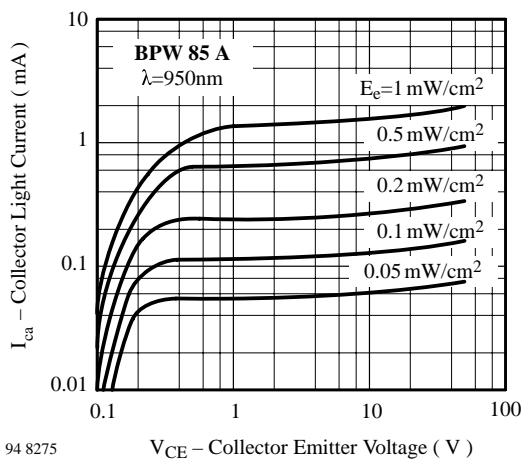

94 8275

Figure 5. Collector Light Current vs. Collector Emitter Voltage

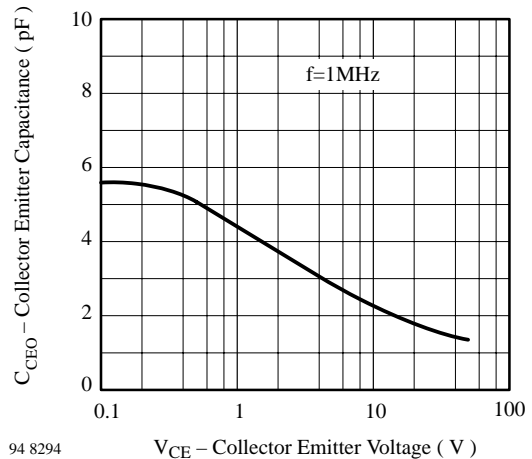

94 8294

Figure 8. Collector Emitter Capacitance vs. Collector Emitter Voltage

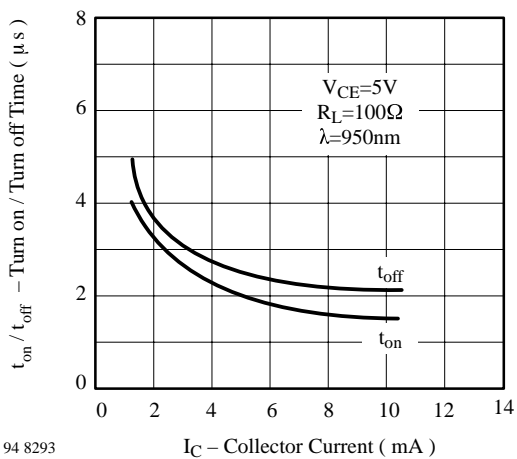

94 8293

Figure 9. Turn On/Turn Off Time vs. Collector Current

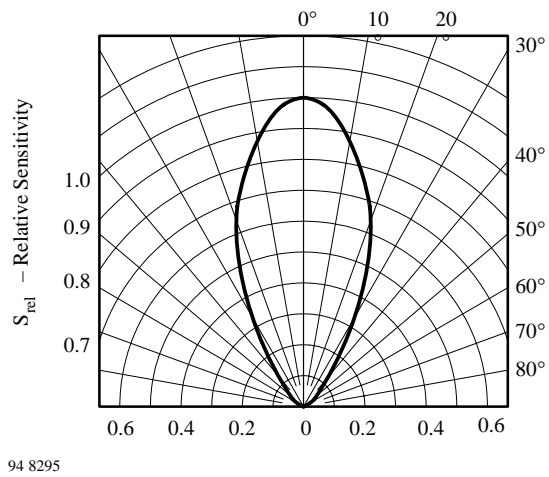

94 8295

Figure 11. Relative Radiant Sensitivity vs. Angular Displacement

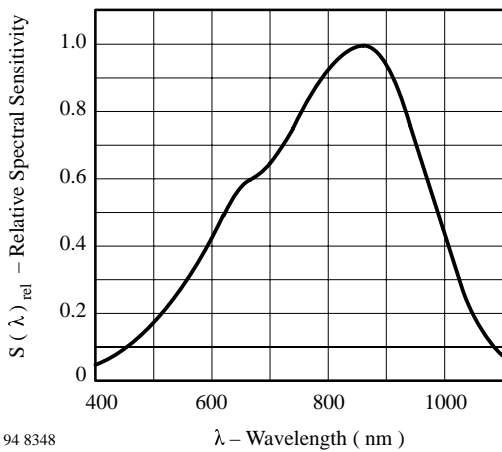

94 8348

Figure 10. Relative Spectral Sensitivity vs. Wavelength

**Dimensions in mm**

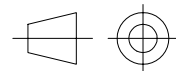
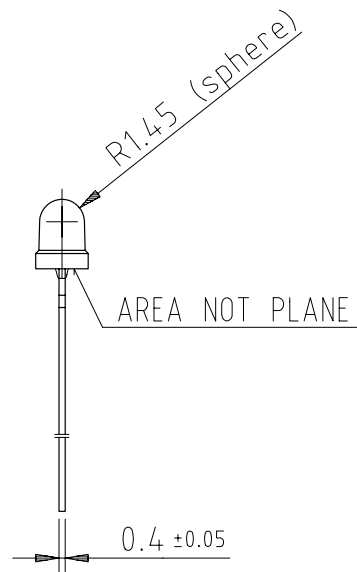
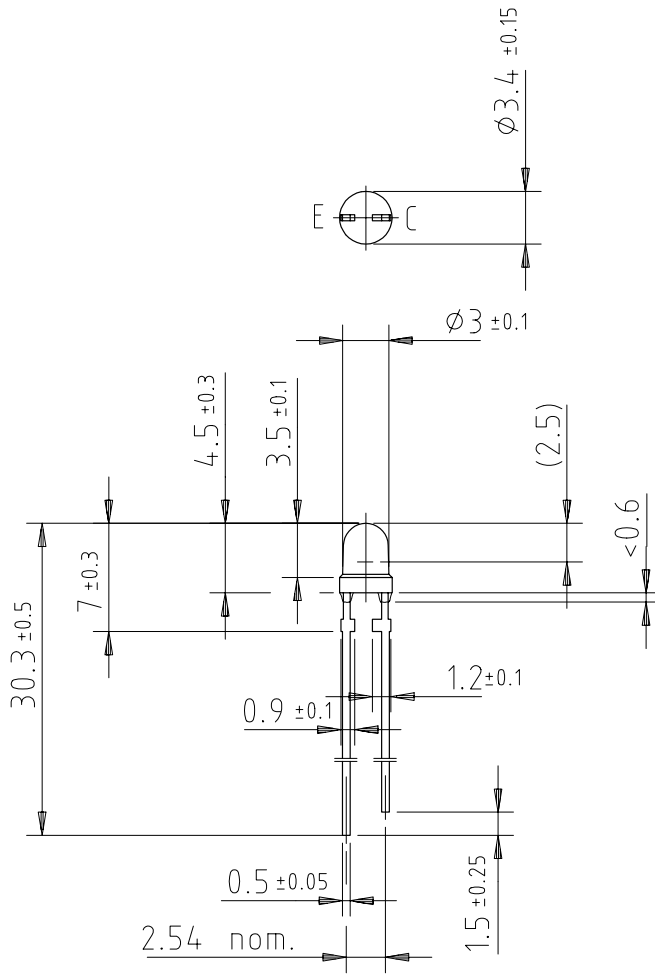

technical drawings  
according to DIN  
specifications

96 12190

**Ozone Depleting Substances Policy Statement**

It is the policy of **Vishay Semiconductor GmbH** to

1. Meet all present and future national and international statutory requirements.
2. Regularly and continuously improve the performance of our products, processes, distribution and operating systems with respect to their impact on the health and safety of our employees and the public, as well as their impact on the environment.

It is particular concern to control or eliminate releases of those substances into the atmosphere which are known as ozone depleting substances (ODSs).

The Montreal Protocol (1987) and its London Amendments (1990) intend to severely restrict the use of ODSs and forbid their use within the next ten years. Various national and international initiatives are pressing for an earlier ban on these substances.

**Vishay Semiconductor GmbH** has been able to use its policy of continuous improvements to eliminate the use of ODSs listed in the following documents.

1. Annex A, B and list of transitional substances of the Montreal Protocol and the London Amendments respectively
2. Class I and II ozone depleting substances in the Clean Air Act Amendments of 1990 by the Environmental Protection Agency (EPA) in the USA
3. Council Decision 88/540/EEC and 91/690/EEC Annex A, B and C (transitional substances) respectively.

**Vishay Semiconductor GmbH** can certify that our semiconductors are not manufactured with ozone depleting substances and do not contain such substances.

**We reserve the right to make changes to improve technical design and may do so without further notice.**

Parameters can vary in different applications. All operating parameters must be validated for each customer application by the customer. Should the buyer use Vishay-Telefunken products for any unintended or unauthorized application, the buyer shall indemnify Vishay-Telefunken against all claims, costs, damages, and expenses, arising out of, directly or indirectly, any claim of personal damage, injury or death associated with such unintended or unauthorized use.

Vishay Semiconductor GmbH, P.O.B. 3535, D-74025 Heilbronn, Germany  
Telephone: 49 (0) 7131 67 2831, Fax number: 49 (0) 7131 67 2423