

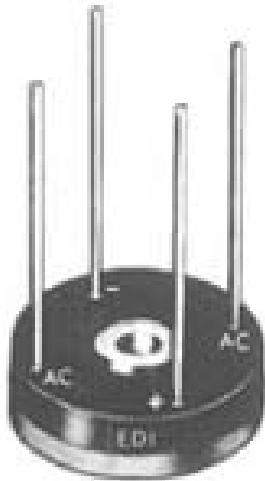

BRUS2 BRUS2F

MINIBRIDGE®

50 ns. ULTRA-FAST RECOVERY
 SINGLE-PHASE, FULL-WAVE BRIDGES
 HEAT SINK • CHASSIS • P.C. BOARD MOUNTING



BRUS2
 9 Amps. Wire Leads

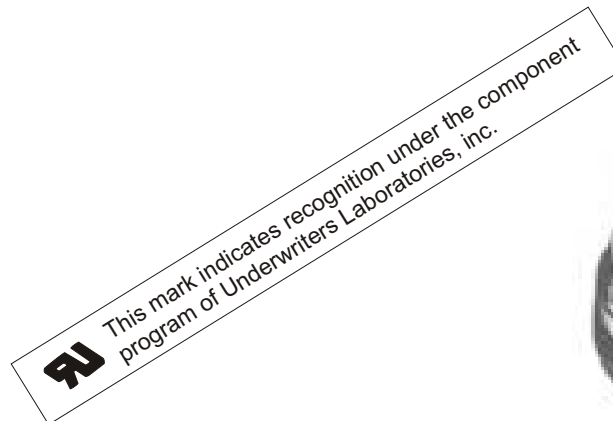

BRUS 2F
 10.5 Amps. Quick-connects

PRV/Leg	50V	100V	200V	400V	600V
9.0 AMP SERIES	BRUS205	BRUS210	BRUS220	BRUS240	BRUS260
10.5AMP SERIES	BRUS205F	BRUS210F	BRUS220F	BRUS240F	BRUS260F

ELECTRICAL CHARACTERISTICS PER LEG (at T _A =25 °C Unless Otherwise Specified)	BRUS2	BRUS2F	UNITS
Average Output Current I _F (Av.) T _c 60 °C (Fig.1)	9.0	10.5	Amps
Max. Forward Voltage Drop, V _F @I _F = 2.0	1.3	1.3	Volts
Max.DC Reverse Current @ PRV and 25°C, I _R	10	10	μA
Max.DC Reverse Current @ PRV and 100°C, I _R	200	200	μA
Max. Reverse Recovery Time, T _{rr} (Fig.4)	50	50	Nanosec.
Max. Peak Surge Current, I _{FSM} (8.3ms)	125	125	Amps
Storage Temperature Range, T _{STG}	-55 to+150		°C
Thermal Resistance (Total Bridge), R _{θj-c}	5.5 typ.	4.5 typ.	°C/W

EDI reserves the right to change these specifications at any time without notice.

BRUS2 BRUS2F

**FIG.1
CURRENT DERATING**

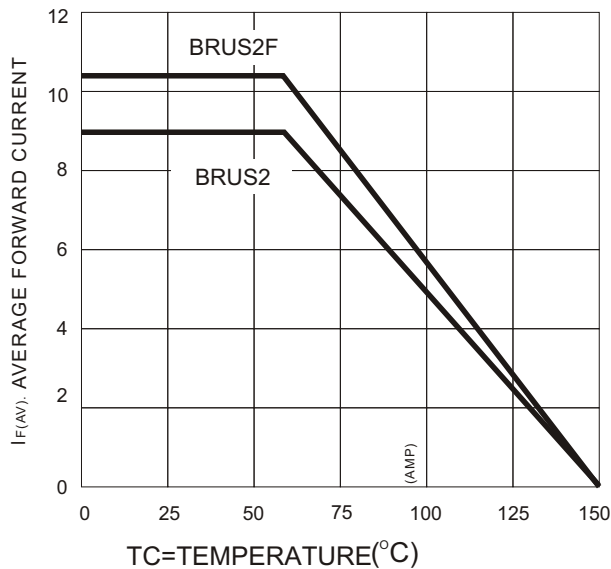

**FIG.2
NON-REPETITIVE SURGE CURRENT**

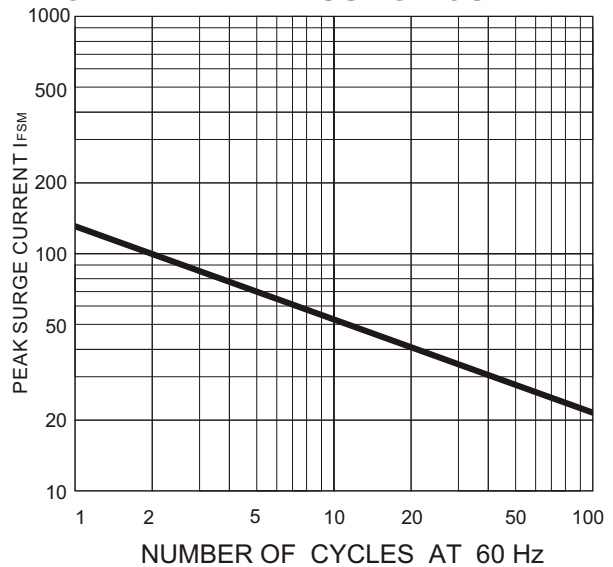

**FIG.3
TEST CIRCUIT**

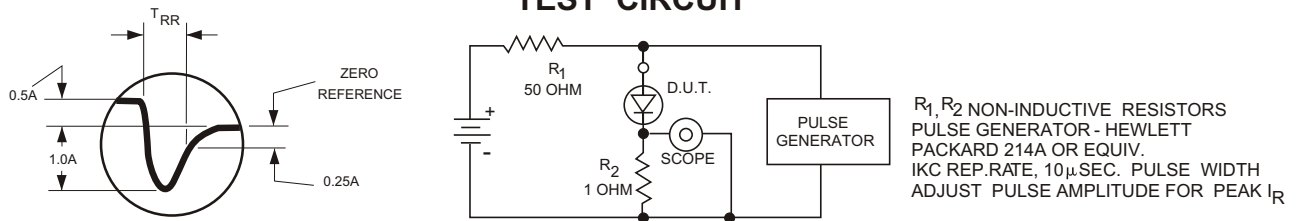

BRUS2-F SERIES MECH. OUTLINE

BRUS2 SERIES MECH. OUTLINE

Dielectric test voltage 1500 volts rms, max. 50-60Hz

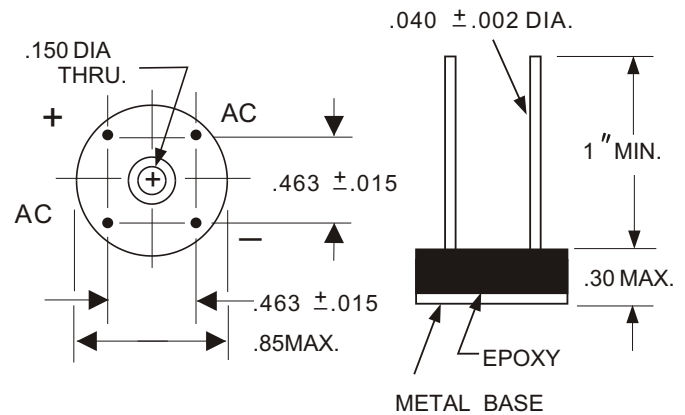
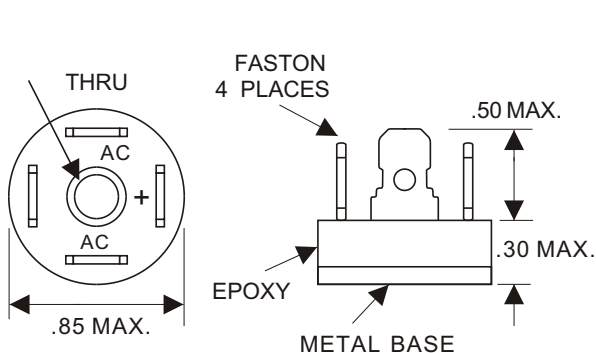

NOTE: A thin film of silicone thermal compound is recommended between the Minibridge[®] case and mounting surface for improved thermal conduction.

ELECTRONIC DEVICES, INC. DESIGNERS AND MANUFACTURERS OF SOLID STATE DEVICES SINCE 1951.

21 GRAY OAKS AVENUE * YONKERS, NEW YORK 10710 914-965-4400 * FAX 914-965-5531 * 1-800-678-0828

e-mail:sales@edidiodes.com * website: http://www.edidiodes.com