

IGBT Power Module

Preliminary data

- Half-bridge
- Including fast free-wheeling diodes
- Enlarged diode area
- Package with insulated metal base plate
- $R_{G\ on,min} = 5.6\ \Omega$

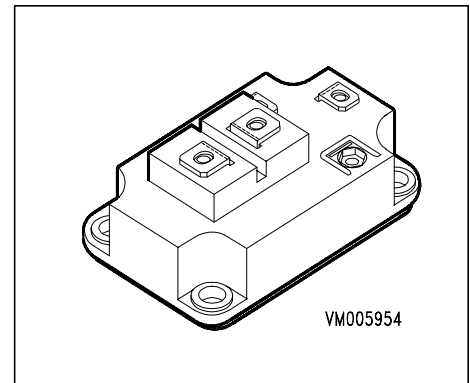

Type	V_{CE}	I_C	Package	Ordering Code
BSM300GA170DN2 E3166	1700V	440A	SINGLE SWITCH 1	C67070-A2710-A67

Maximum Ratings

Parameter	Symbol	Values	Unit
Collector-emitter voltage	V_{CE}	1700	V
Collector-gate voltage	V_{CGR}	1700	
$R_{GE} = 20\ k\Omega$			
Gate-emitter voltage	V_{GE}	± 20	
DC collector current	I_C	440	A
$T_C = 25\ ^\circ C$			
$T_C = 80\ ^\circ C$		300	
Pulsed collector current, $t_p = 1\ ms$	I_{Cpuls}	880	
$T_C = 25\ ^\circ C$			
$T_C = 80\ ^\circ C$		600	
Power dissipation per IGBT	P_{tot}	2500	W
$T_C = 25\ ^\circ C$			
Chip temperature	T_j	+ 150	$^\circ C$
Storage temperature	T_{stg}	-55 ... + 150	
Thermal resistance, chip case	R_{thJC}	≤ 0.05	K/W
Diode thermal resistance, chip case	R_{thJCD}	≤ 0.1	
Insulation test voltage, $t = 1\ min.$	V_{is}	4000	Vac
Creepage distance	-	20	mm
Clearance	-	11	
DIN humidity category, DIN 40 040	-	F	-
IEC climatic category, DIN IEC 68-1	-	55 / 150 / 56	

Electrical Characteristics, at $T_j = 25\text{ °C}$, unless otherwise specified

Parameter	Symbol	Values			Unit
		min.	typ.	max.	

Static Characteristics

Gate threshold voltage $V_{GE} = V_{CE}, I_C = 20\text{ mA}$	$V_{GE(th)}$	4.8	5.5	6.2	V
Collector-emitter saturation voltage $V_{GE} = 15\text{ V}, I_C = 300\text{ A}, T_j = 25\text{ °C}$ $V_{GE} = 15\text{ V}, I_C = 300\text{ A}, T_j = 125\text{ °C}$	$V_{CE(sat)}$	- -	3.4 4.6	3.9 5.3	
Zero gate voltage collector current $V_{CE} = 1700\text{ V}, V_{GE} = 0\text{ V}, T_j = 25\text{ °C}$ $V_{CE} = 1700\text{ V}, V_{GE} = 0\text{ V}, T_j = 125\text{ °C}$	I_{CES}	- -	2 8	3 -	mA
Gate-emitter leakage current $V_{GE} = 20\text{ V}, V_{CE} = 0\text{ V}$	I_{GES}	-	-	400	nA

AC Characteristics

Transconductance $V_{CE} = 20\text{ V}, I_C = 300\text{ A}$	g_{fs}	108	-	-	S
Input capacitance $V_{CE} = 25\text{ V}, V_{GE} = 0\text{ V}, f = 1\text{ MHz}$	C_{iss}	-	44	-	nF
Output capacitance $V_{CE} = 25\text{ V}, V_{GE} = 0\text{ V}, f = 1\text{ MHz}$	C_{oss}	-	3.5	-	
Reverse transfer capacitance $V_{CE} = 25\text{ V}, V_{GE} = 0\text{ V}, f = 1\text{ MHz}$	C_{rss}	-	1	-	

Electrical Characteristics, at $T_j = 25\text{ °C}$, unless otherwise specified

Parameter	Symbol	Values			Unit
		min.	typ.	max.	

Switching Characteristics, Inductive Load at $T_j = 125\text{ °C}$

Turn-on delay time $V_{CC} = 1200\text{ V}$, $V_{GE} = 15\text{ V}$, $I_C = 300\text{ A}$ $R_{Gon} = 5.6\ \Omega$	$t_{d(on)}$	-	600	1200	ns
Rise time $V_{CC} = 1200\text{ V}$, $V_{GE} = 15\text{ V}$, $I_C = 300\text{ A}$ $R_{Gon} = 5.6\ \Omega$	t_r	-	200	400	
Turn-off delay time $V_{CC} = 1200\text{ V}$, $V_{GE} = -15\text{ V}$, $I_C = 300\text{ A}$ $R_{Goff} = 5.6\ \Omega$	$t_{d(off)}$	-	1280	1900	
Fall time $V_{CC} = 1200\text{ V}$, $V_{GE} = -15\text{ V}$, $I_C = 300\text{ A}$ $R_{Goff} = 5.6\ \Omega$	t_f	-	110	160	

Free-Wheel Diode

Diode forward voltage $I_F = 300\text{ A}$, $V_{GE} = 0\text{ V}$, $T_j = 25\text{ °C}$ $I_F = 300\text{ A}$, $V_{GE} = 0\text{ V}$, $T_j = 125\text{ °C}$	V_F	-	2 1.8	2.5 -	V
Reverse recovery time $I_F = 300\text{ A}$, $V_R = -1200\text{ V}$, $V_{GE} = 0\text{ V}$ $di_F/dt = -1500\text{ A}/\mu\text{s}$, $T_j = 125\text{ °C}$	t_{rr}	-	1	-	
Reverse recovery charge $I_F = 300\text{ A}$, $V_R = -1200\text{ V}$, $V_{GE} = 0\text{ V}$ $di_F/dt = -1500\text{ A}/\mu\text{s}$ $T_j = 25\text{ °C}$ $T_j = 125\text{ °C}$	Q_{rr}	-	28 100	- -	μC

Power dissipation

$$P_{\text{tot}} = f(T_C)$$

parameter: $T_j \leq 150^\circ\text{C}$

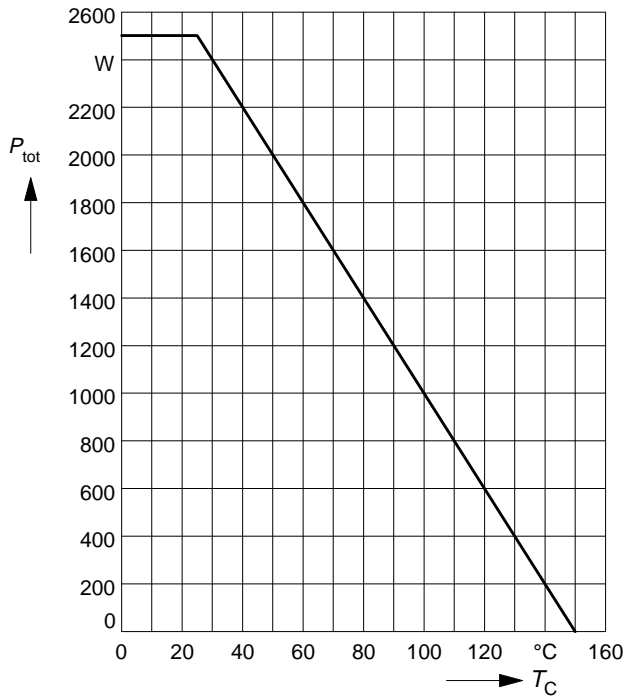

Safe operating area

$$I_C = f(V_{\text{CE}})$$

parameter: $D = 0, T_C = 25^\circ\text{C}, T_j \leq 150^\circ\text{C}$

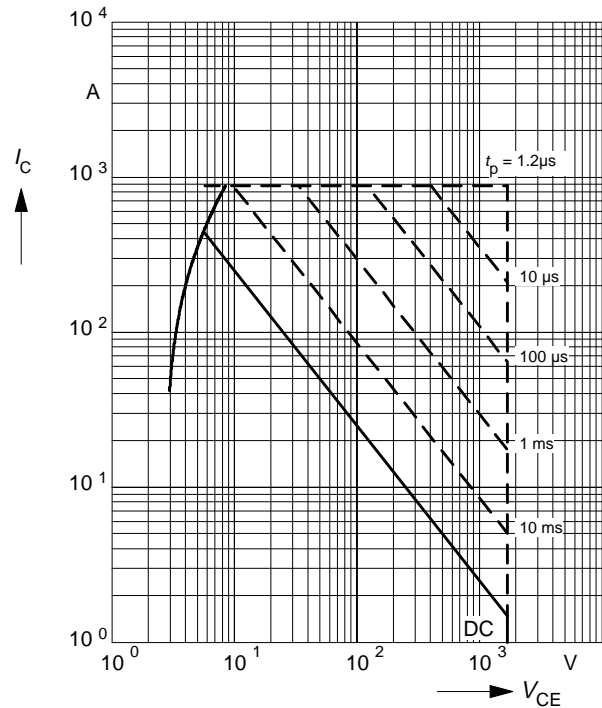

Collector current

$$I_C = f(T_C)$$

parameter: $V_{\text{GE}} \geq 15\text{ V}, T_j \leq 150^\circ\text{C}$

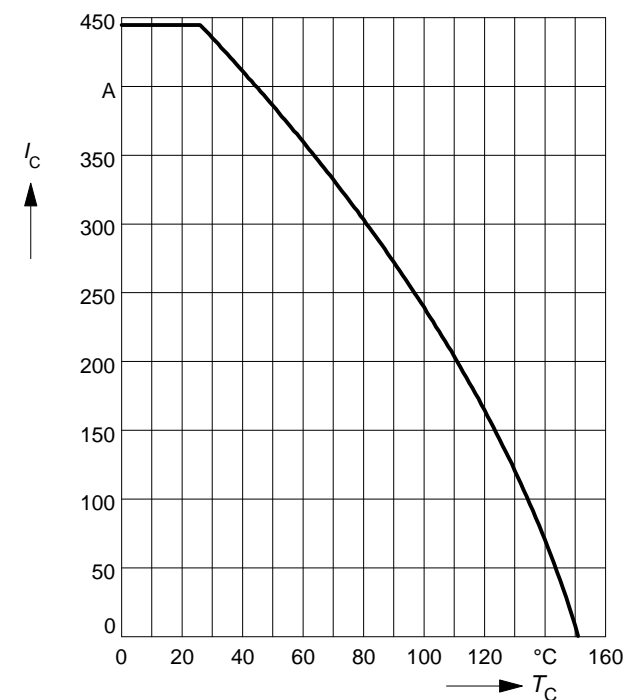

Transient thermal impedance IGBT

$$Z_{\text{thJC}} = f(t_p)$$

parameter: $D = t_p / T$

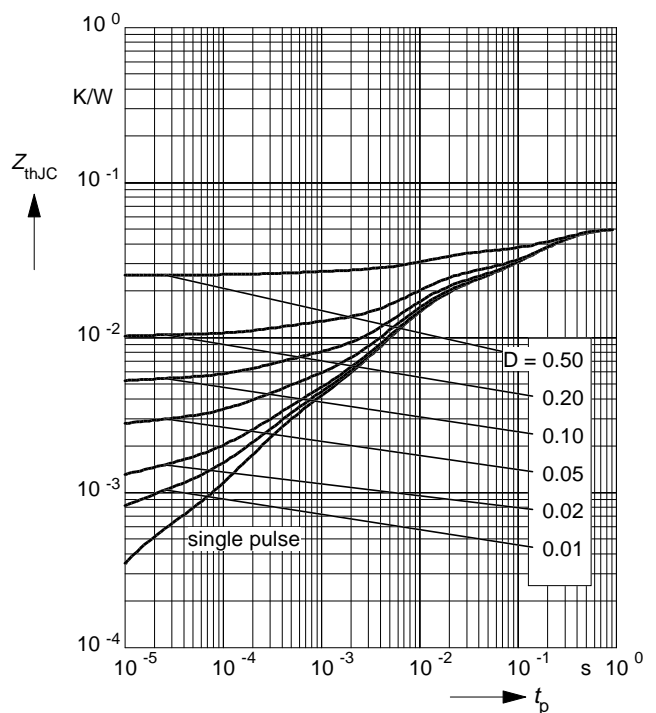

Typ. output characteristics

$$I_C = f(V_{CE})$$

parameter: $t_p = 80 \mu s$, $T_j = 25 \text{ }^\circ\text{C}$

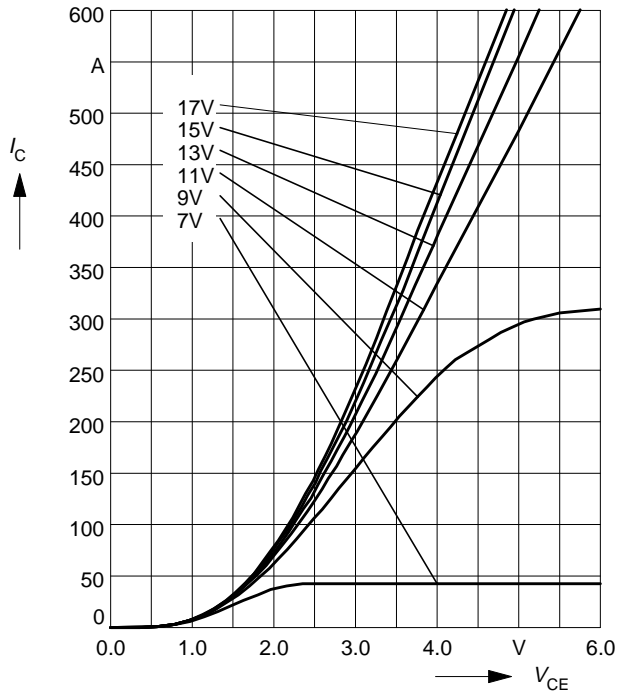

Typ. output characteristics

$$I_C = f(V_{CE})$$

parameter: $t_p = 80 \mu s$, $T_j = 125 \text{ }^\circ\text{C}$

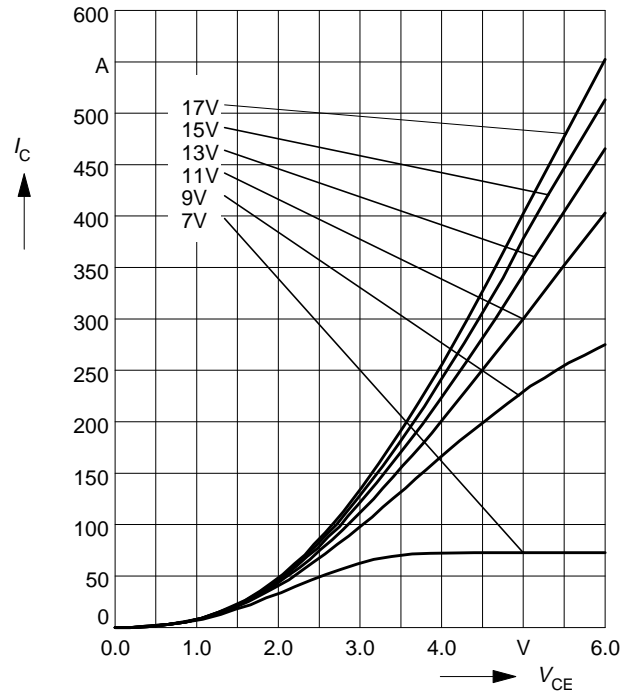

Typ. transfer characteristics

$$I_C = f(V_{GE})$$

parameter: $t_p = 80 \mu s$, $V_{CE} = 20 \text{ V}$

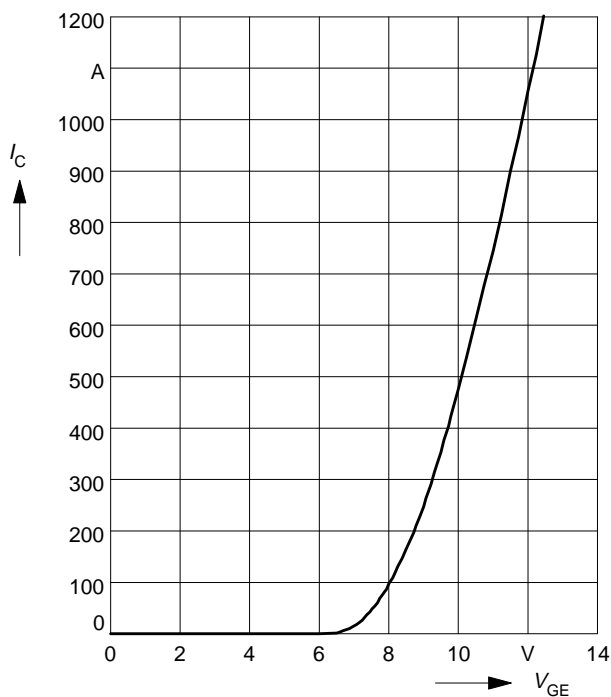

Typ. gate charge

$$V_{GE} = f(Q_{Gate})$$

parameter: $I_{C\ puls} = 300\text{ A}$

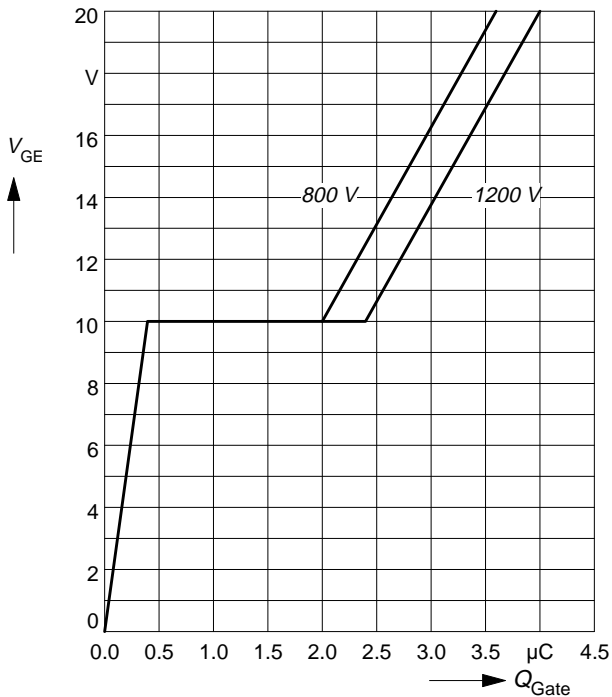

Typ. capacitances

$$C = f(V_{CE})$$

parameter: $V_{GE} = 0, f = 1\text{ MHz}$

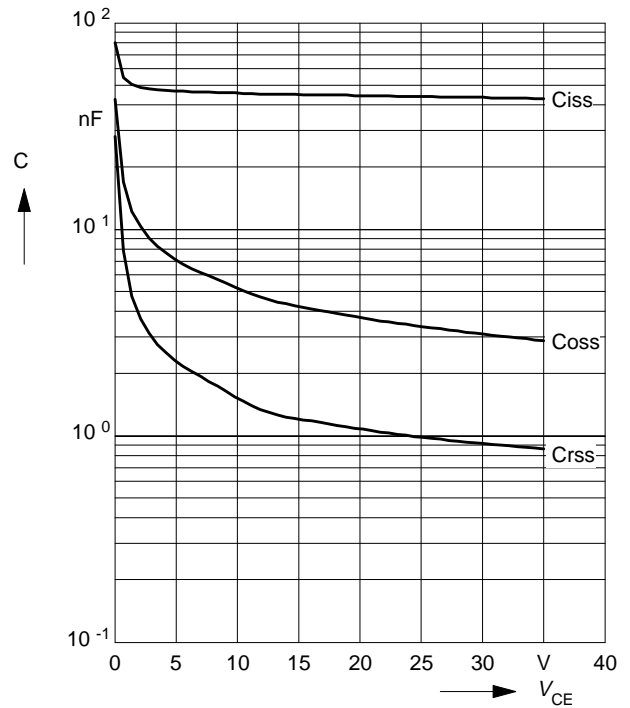

Reverse biased safe operating area

$$I_{C\ puls} = f(V_{CE}), T_j = 150^\circ\text{C}$$

parameter: $V_{GE} = 15\text{ V}$

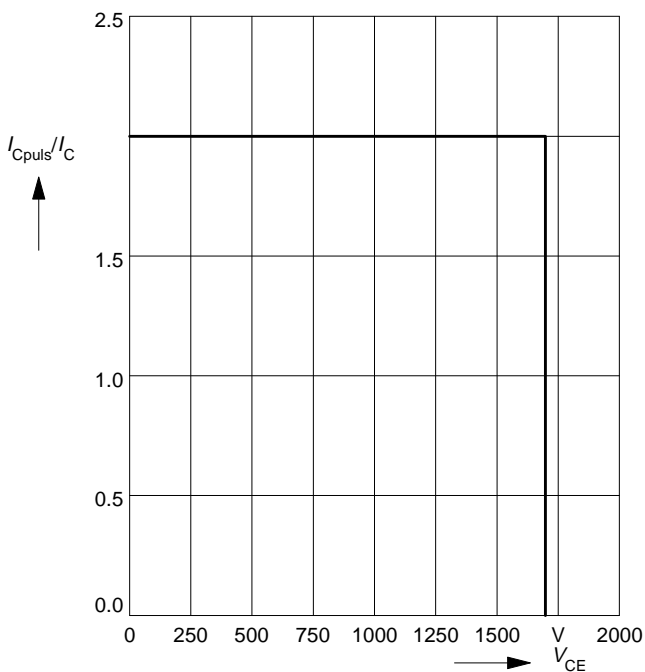

Short circuit safe operating area

$$I_{C\ sc} = f(V_{CE}), T_j = 150^\circ\text{C}$$

parameter: $V_{GE} = \pm 15\text{ V}, t_{SC} \leq 10\ \mu\text{s}, L < 20\text{ nH}$

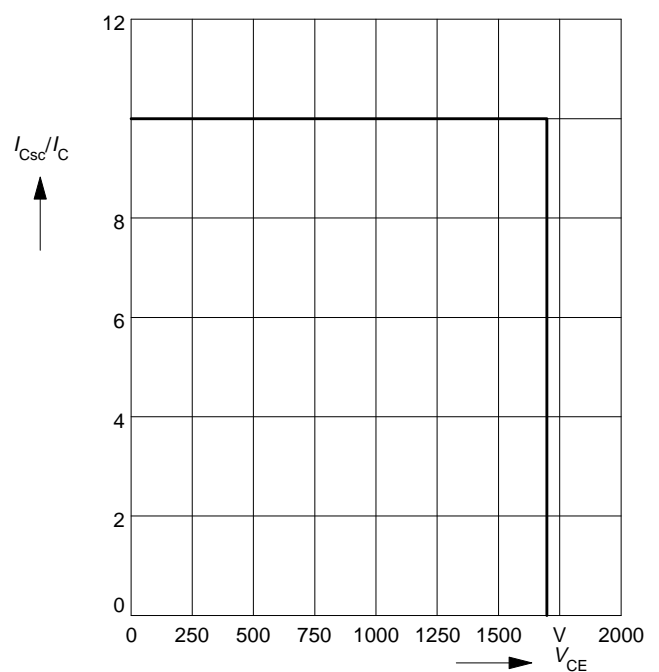

Typ. switching time

$t = f(I_C)$, inductive load, $T_j = 125^\circ\text{C}$
 par.: $V_{CE} = 1200\text{ V}$, $V_{GE} = \pm 15\text{ V}$, $R_G = 5.6\ \Omega$

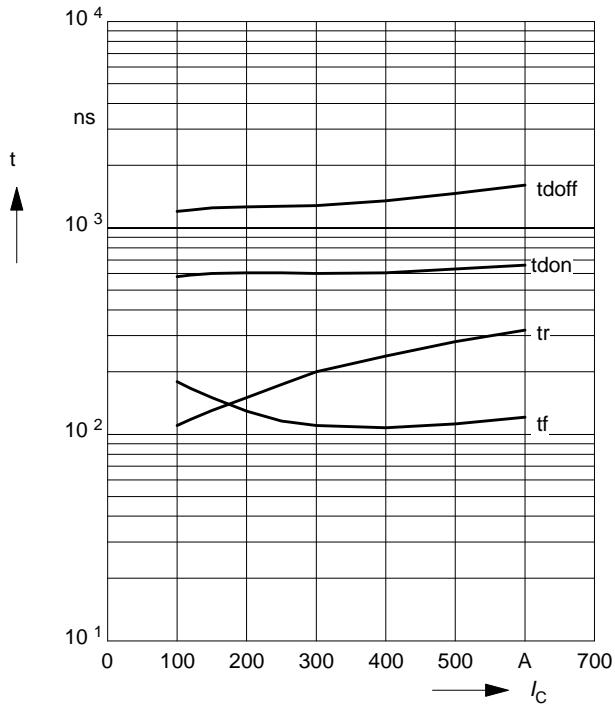

Typ. switching time

$t = f(R_G)$, inductive load, $T_j = 125^\circ\text{C}$
 par.: $V_{CE} = 1200\text{ V}$, $V_{GE} = \pm 15\text{ V}$, $I_C = 300\text{ A}$

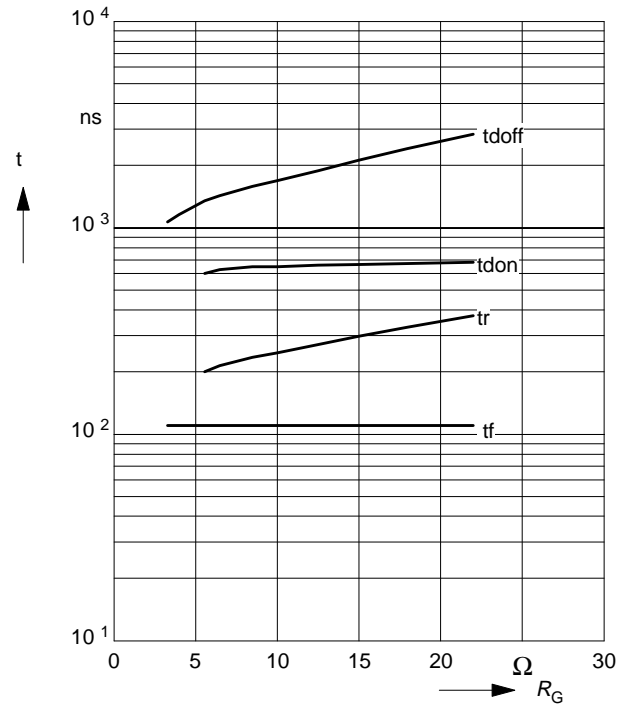

Typ. switching losses

$E = f(I_C)$, inductive load, $T_j = 125^\circ\text{C}$
 par.: $V_{CE} = 1200\text{ V}$, $V_{GE} = \pm 15\text{ V}$, $R_G = 5.6\ \Omega$

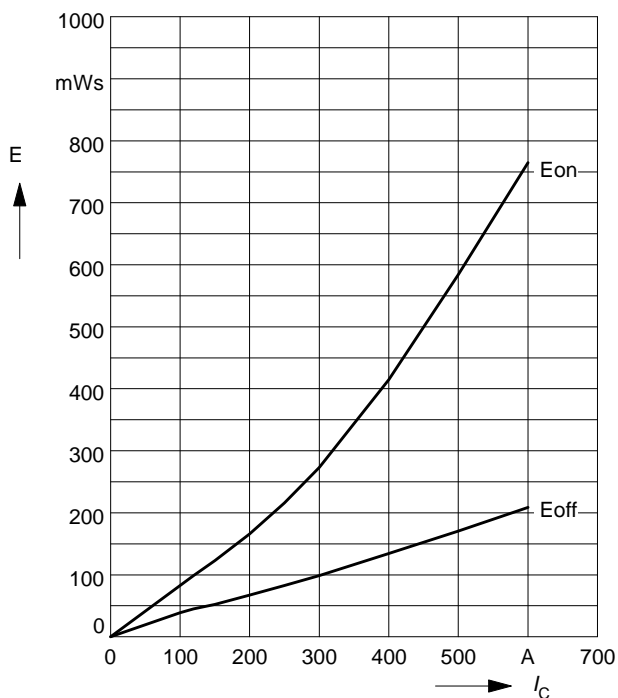

Typ. switching losses

$E = f(R_G)$, inductive load, $T_j = 125^\circ\text{C}$
 par.: $V_{CE} = 1200\text{ V}$, $V_{GE} = \pm 15\text{ V}$, $I_C = 300\text{ A}$

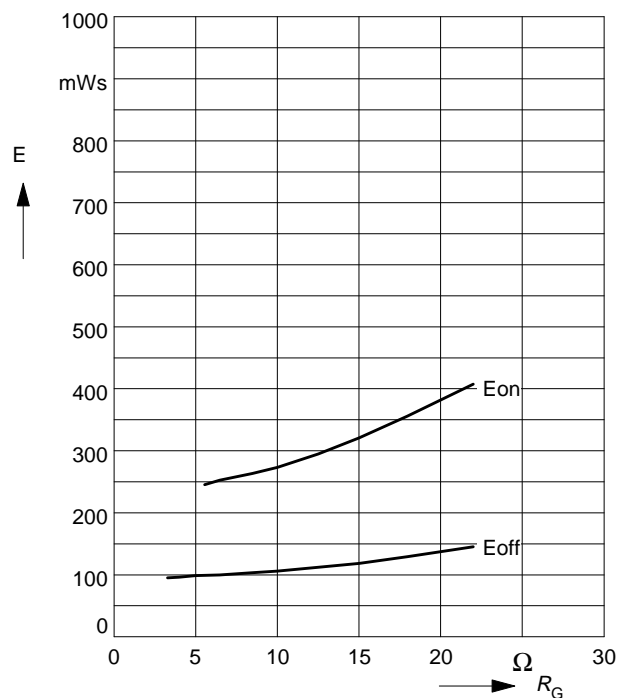

Forward characteristics of fast recovery reverse diode $I_F = f(V_F)$
 parameter: T_j

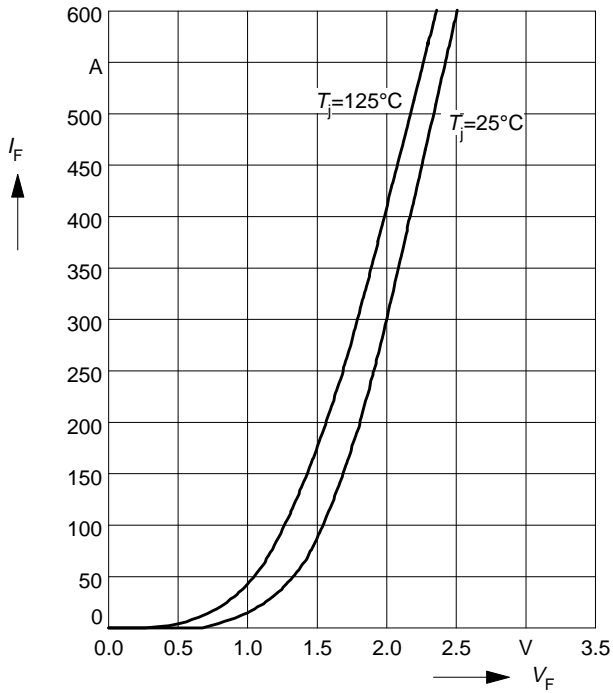

Transient thermal impedance Diode
 $Z_{thJC} = f(t_p)$
 parameter: $D = t_p / T$

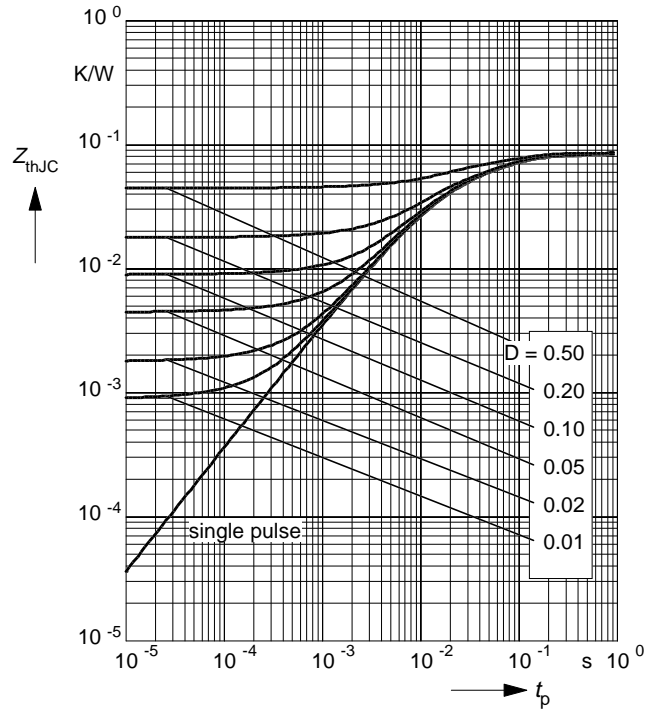

Circuit Diagram

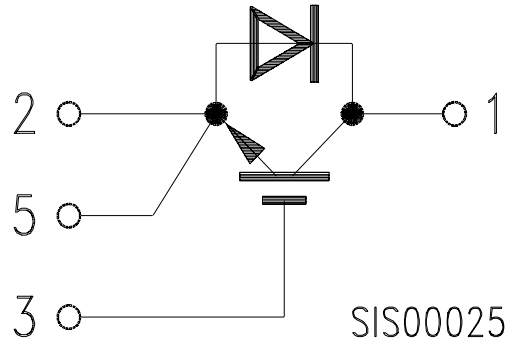

Package Outlines

Dimensions in mm

Weight: 420 g

