

PNP Silicon Darlington Transistors

- High collector current
- Low collector-emitter saturation voltage
- Complementary types: BSP50 ... BSP52 (NPN)

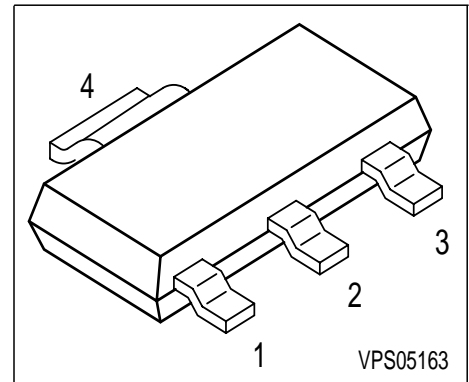

Type	Marking	Pin Configuration				Package
BSP60	BSP 60	1 = B	2 = C	3 = E	4 = C	SOT223
BSP61	BSP 61	1 = B	2 = C	3 = E	4 = C	SOT223
BSP62	BSP 62	1 = B	2 = C	3 = E	4 = C	SOT223

Maximum Ratings

Parameter	Symbol	BSP60	BSP61	BSP62	Unit
Collector-emitter voltage	V_{CEO}	45	60	80	V
Collector-base voltage	V_{CBO}	60	80	90	
Emitter-base voltage	V_{EBO}	5	5	5	
DC collector current	I_C	1			A
Peak collector current	I_{CM}	2			
Base current	I_B	100			mA
Total power dissipation, $T_S = 124\text{ °C}$	P_{tot}	1.5			W
Junction temperature	T_j	150			°C
Storage temperature	T_{stg}	-65 ... 150			

Thermal Resistance

Junction - soldering point ¹⁾	R_{thJS}	≤17	K/W
--	------------	-----	-----

¹⁾For calculation of R_{thJA} please refer to Application Note Thermal Resistance

Electrical Characteristics at $T_A = 25^\circ\text{C}$, unless otherwise specified

Parameter	Symbol	Values			Unit
		min.	typ.	max.	
DC Characteristics					
Collector-emitter breakdown voltage $I_C = 10\text{ mA}, I_B = 0$	$V_{(BR)CEO}$				V
BSP60		45	-	-	
BSP61		60	-	-	
		BSP62	80	-	-
Collector-base breakdown voltage $I_C = 100\ \mu\text{A}, I_E = 0$	$V_{(BR)CBO}$				V
BSP60		60	-	-	
BSP61		80	-	-	
		BSP62	90	-	-
Emitter-base breakdown voltage $I_E = 100\ \mu\text{A}, I_C = 0$	$V_{(BR)EBO}$	5	-	-	
Collector-emitter cutoff current $V_{CE} = V_{CE0max}, V_{BE} = 0$	I_{CES}	-	-	10	μA
Emitter cutoff current $V_{EB} = 4\text{ V}, I_C = 0$	I_{EBO}	-	-	10	
DC current gain 1) $I_C = 150\text{ mA}, V_{CE} = 10\text{ V}$ $I_C = 500\text{ mA}, V_{CE} = 10\text{ V}$	h_{FE}				-
		1000	-	-	
		2000	-	-	
Collector-emitter saturation voltage1) $I_C = 500\text{ mA}, I_B = 0.55\text{ mA}$ $I_C = 1\text{ A}, I_B = 1\text{ mA}$	V_{CEsat}				V
		-	-	1.3	
		-	-	1.8	
Base-emitter saturation voltage 1) $I_C = 500\text{ mA}, I_B = 0.5\text{ mA}$ $I_C = 1\text{ A}, I_B = 1\text{ mA}$	V_{BEsat}				V
		-	-	1.9	
		-	-	2.2	
AC Characteristics					
Transition frequency $I_C = 100\text{ mA}, V_{CE} = 5\text{ V}, f = 100\text{ MHz}$	f_T	-	200	-	MHz
Turn-on time $I_C = 500\text{ mA}, I_{B1} = I_{B2} = 0.5\text{ mA}$	$t_{(on)}$	-	400	-	ns
Turn-off time $I_C = 500\text{ mA}, I_{B1} = I_{B2} = 0.5\text{ mA}$	$t_{(off)}$	-	1500	-	

 1) Pulse test: $t \leq 300\ \mu\text{s}$, $D = 2\%$

Switching time test circuit

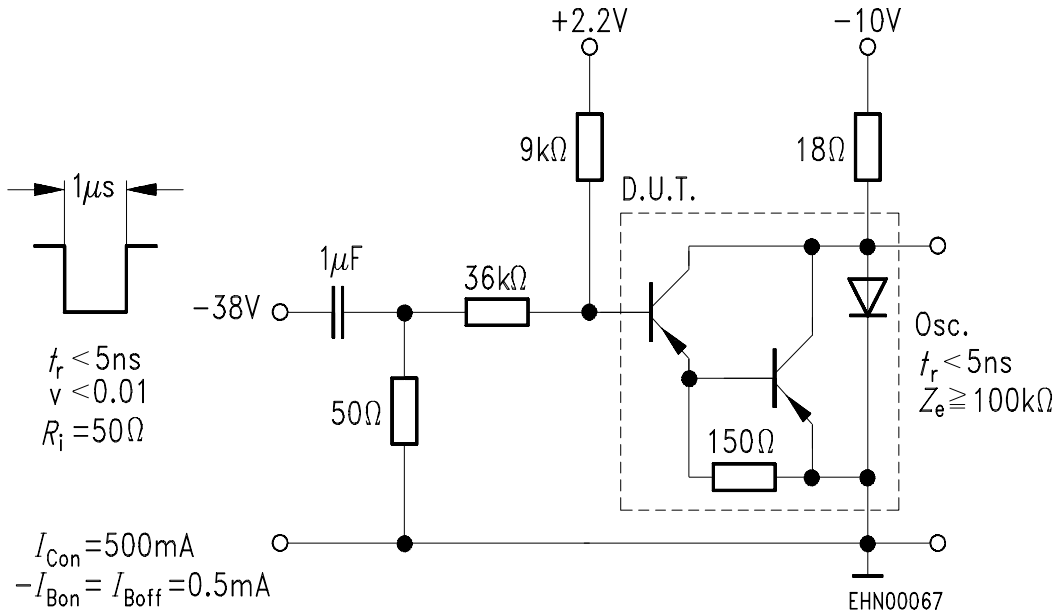

Switching time waveform

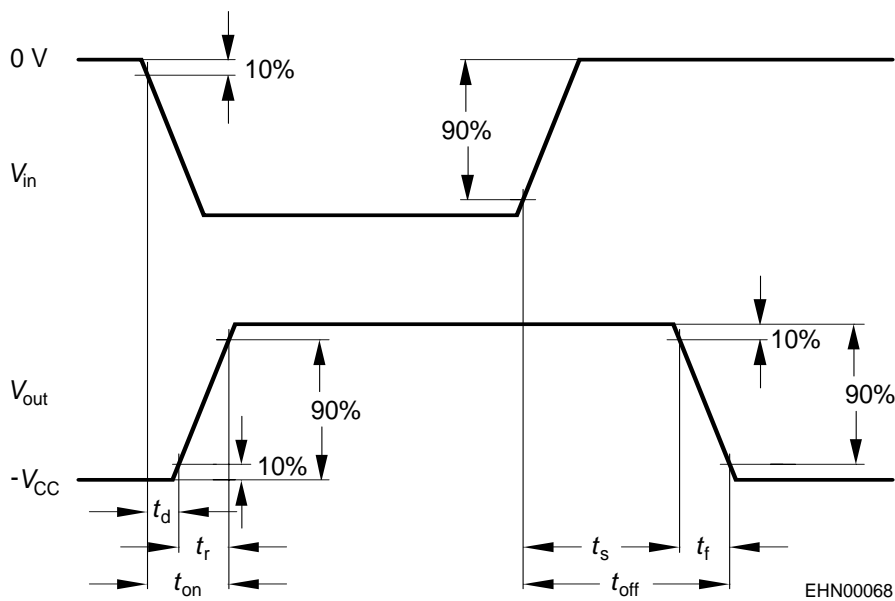

1) Pulse test: $t \leq 300\mu\text{s}$, $D = 2\%$

Total power dissipation $P_{tot} = f(T_S)$

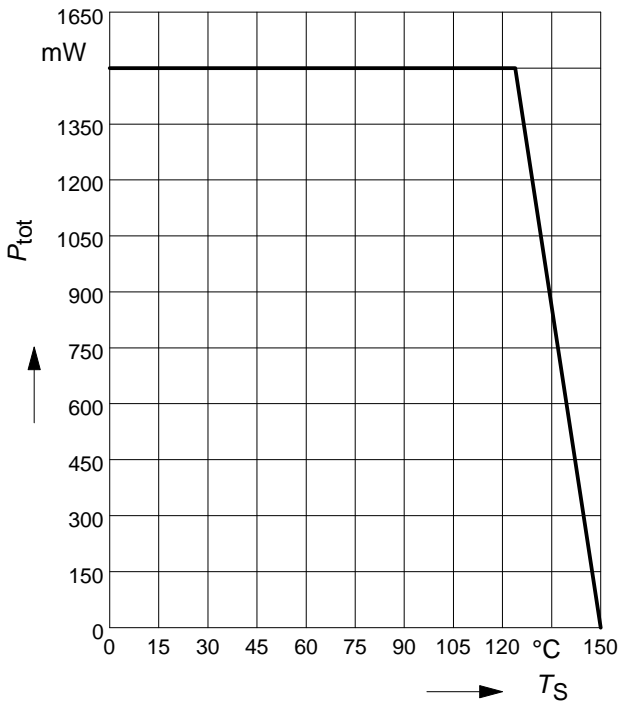

External resistance $R_{BE} = f(T_A)$**

$V_{CB} = V_{CEmax}$

** R_{BEmax} for thermal stability

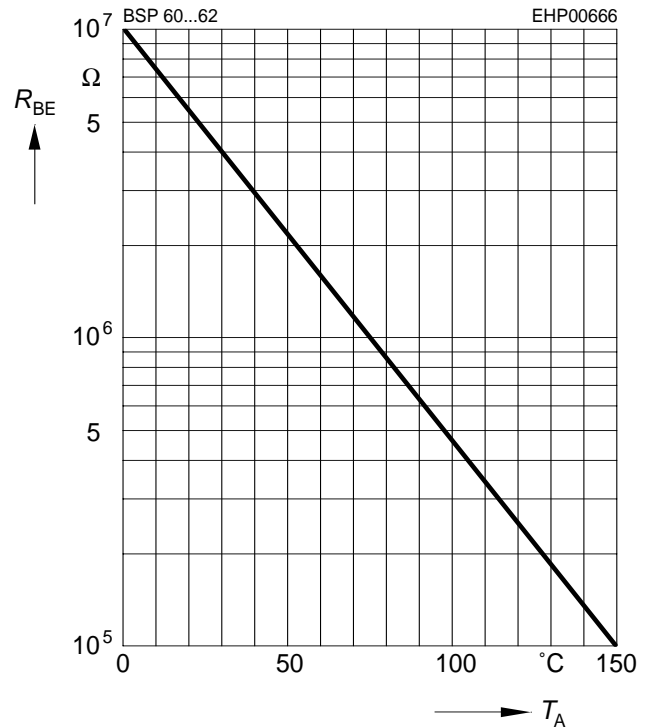

Permissible pulse load

$P_{totmax} / P_{totDC} = f(t_p)$

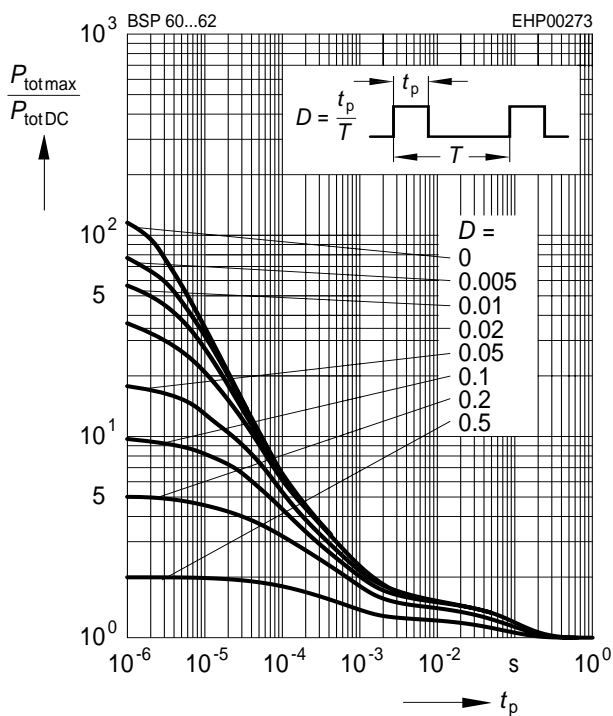

DC current gain $h_{FE} = f(I_C)$

$V_{CE} = 10V$

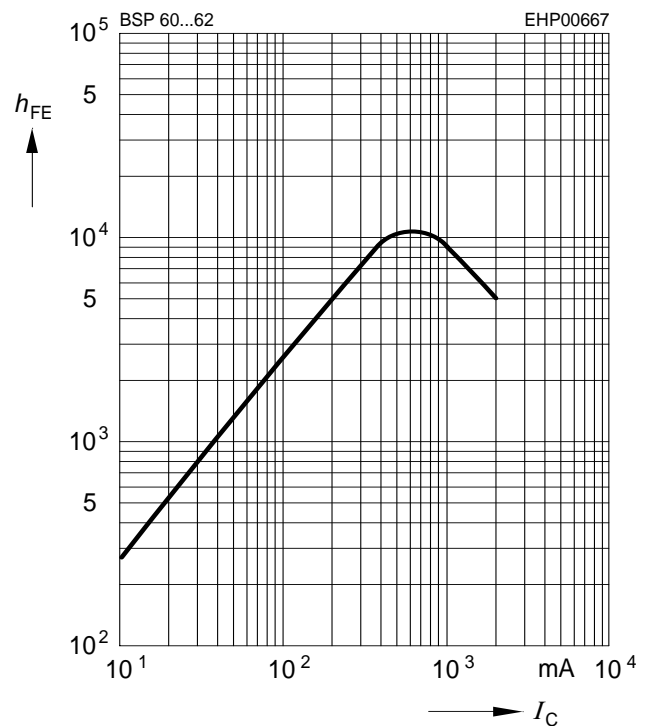

Collector-emitter saturation voltage

$I_C = f(V_{CEsat}), I_B$ - parameter

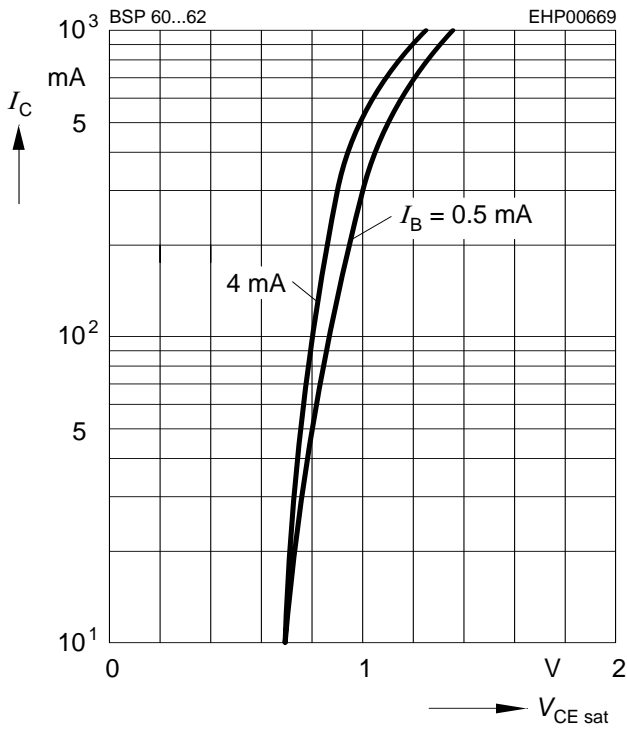

Base-emitter saturation voltage

$I_C = f(V_{BEsat}), I_B$ - parameter

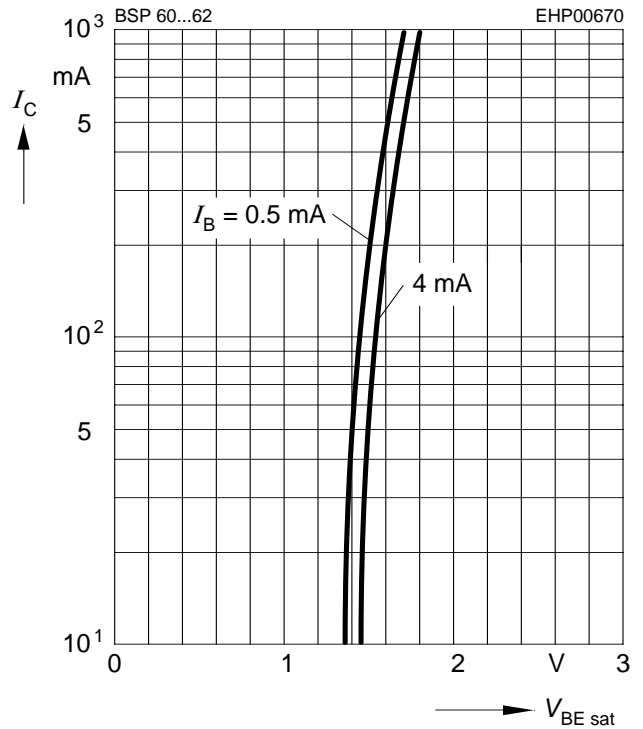

Transition frequency $f_T = f(I_C)$

$V_{CE} = 10V, f = 100MHz$

