

UTC BT150

SCRs

DESCRIPTION

Passivated thyristors in a plastic envelope, intended for use in applications requiring high bidirectional blocking voltage capability and high thermal cycling performance. Typical applications include motor control, industrial and domestic lighting, heating and static switching.

SYMBOL

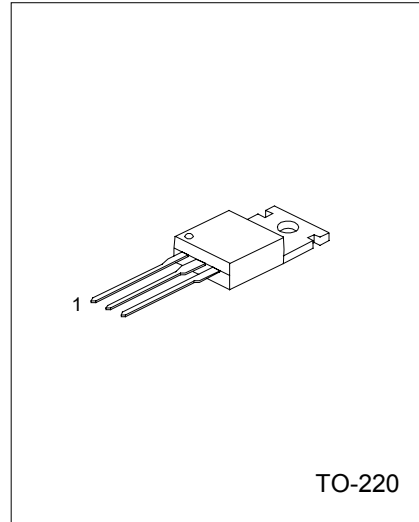
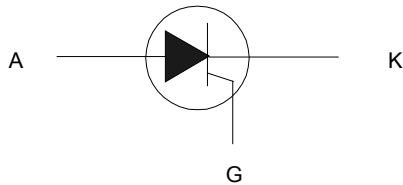

1: CATHODE 2: ANODE 3: GATE

ABSOLUTE MAXIMUM RATINGS.

| PARAMETER | SYMBOL | RATING | UNIT |
|--|-----------------------|---------------------|------------------------|
| Repetitive peak off-state voltages BT150-500 BT150-650 BT150-800 | V_{DRM} , V_{RRM} | 500* 650* 800 | V |
| Average on-state current (half sine wave; $T_{mb} \leq 113^\circ\text{C}$) | $I_{T(AV)}$ | 2.5 | A |
| RMS on-state current (all conduction angles) | $I_{T(RMS)}$ | 4 | A |
| Non-repetitive peak on-state current (half sine wave; $T_j = 25^\circ\text{C}$ prior to surge) $t = 10$ ms $t = 8.3$ ms | I_{TSM} | 35 38 | A |
| I^2t for fusing ($t = 10$ ms) | I^2t | 6.1 | A^2s |
| Repetitive rate of rise of on-state current after triggering ($I_{TM} = 10$ A; $I_G = 50$ mA; $dI_G/dt = 50$ mA/ms) | dI_T/dt | 50 | $\text{A}/\mu\text{s}$ |
| Peak gate current | I_{GM} | 2 | A |
| Peak gate voltage | V_{GM} | 5 | V |
| Peak reverse gate voltage | V_{RGM} | 5 | V |
| Peak gate power (over any 20 ms period) | P_{GM} | 5 | W |
| Average gate power | $P_{G(AV)}$ | 0.5 | W |
| Storage temperature | T_{stg} | -40~150 | $^\circ\text{C}$ |
| Operating junction temperature | T_j | 125** | $^\circ\text{C}$ |

*Although not recommended, off-state voltages up to 800V may be applied without damage, but the thyristor may switch to the on-state. The rate of rise of current should not exceed $15\text{A}/\mu\text{s}$.

** Note: operation above 110°C may require the use of a gate to cathode resistor of $1\text{k}\Omega$ or less.

UTC BT150

THERMAL RESISTANCES

| PARAMETER | SYMBOL | MIN | TYP | MAX | UNIT |
|--|----------------|-----|-----|-----|------|
| Thermal resistance Junction to mounting base | $R_{th\ j-mb}$ | | | 2.5 | K/W |
| Thermal resistance Junction to ambient In free air | $R_{th\ j-a}$ | | 60 | | K/W |

STATIC CHARACTERISTICS ($T_j=25^\circ\text{C}$, unless otherwise stated)

| PARAMETER | SYMBOL | CONDITIONS | MIN | TYP | MAX | UNIT |
|---------------------------|------------|--|-----|------------|-----|------|
| Gate trigger current | I_{GT} | $V_D = 12\text{ V}; I_T = 0.1\text{ A}$ | | 15 | 200 | mA |
| Latching current | I_L | $V_D = 12\text{ V}; I_{GT} = 0.1\text{ A}$ | | 0.17 | 10 | mA |
| Holding current | I_H | $V_D = 12\text{ V}; I_{GT} = 0.1\text{ A}$ | | 0.10 | 6 | mA |
| On-state voltage | V_T | $I_T = 5\text{ A}$ | | 1.23 | 1.8 | V |
| Gate trigger voltage | V_{GT} | $V_D = 12\text{ V}; I_T = 0.1\text{ A}$ $V_D = V_{DRM(max)}; I_T = 0.1\text{ A}; T_j = 110^\circ\text{C}$ | 0.1 | 0.4 0.2 | 1.5 | V |
| Off-state leakage current | I_D, I_R | $V_D = V_{DRM(max)}; V_R = V_{RRM(max)};$ $T_j = 125^\circ\text{C}$ | | 0.1 | 0.5 | mA |

DYNAMIC CHARACTERISTICS ($T_j=25^\circ\text{C}$, unless otherwise stated)

| PARAMETER | SYMBOL | CONDITIONS | MIN | TYP | MAX | UNIT |
|--|-----------|---|-----|-----|-----|------------------|
| Critical rate of rise of off-state voltage | dV_D/dt | $V_{DM} = 67\% V_{DRM(max)}; T_j = 125^\circ\text{C};$ exponential waveform; $R_{GK} = 100\ \Omega$ | | 50 | | V/ μs |
| Gate controlled turn-on time | t_{gt} | $I_{TM} = 10\text{ A}; V_D = V_{DRM(max)}; I_G = 5\text{ mA};$ $dI_G/dt = 0.2\text{ A}/\mu\text{s}$ | | 2 | | μs |
| Circuit commutated Turn-off time | t_q | $V_D = 67\% V_{DRM(max)}; T_j = 125^\circ\text{C};$ $I_{TM} = 8\text{ A}; V_R = 10\text{ V}; dI_{TM}/dt = 10\text{ A}/\mu\text{s};$ $dV_D/dt = 2\text{ V}/\mu\text{s}; R_{GK} = 1\text{ k}\Omega$ | | 100 | | μs |

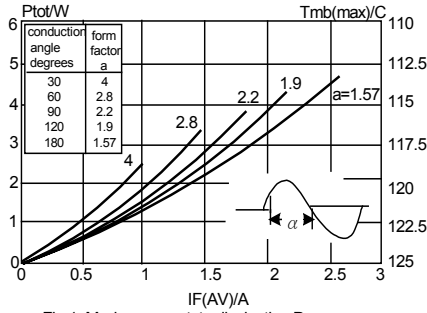

Fig. 1. Maximum on-state dissipation, P_{tot} , versus average on-state current, $I_{T(AV)}$ where $a = \text{form factor} = I_{T(RMS)} / I_{T(AV)}$

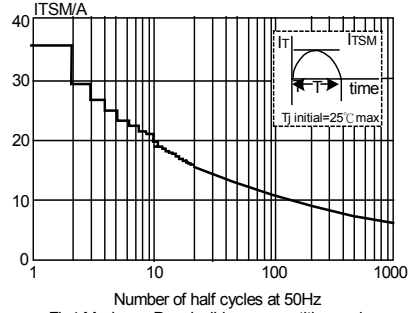

Fig. 4. Maximum Permissible non-repetitive peak on-state current I_{TSM} , versus number of cycles, for sinusoidal currents, $f=50\text{Hz}$.

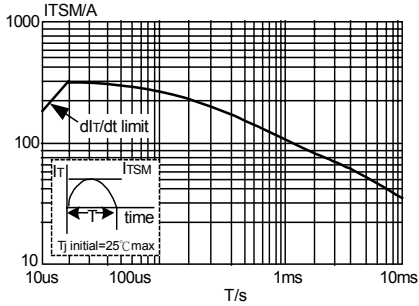

Fig. 2. Maximum Permissible non-repetitive peak on-state Current I_{TSM} , versus pulse width t_p for sinusoidal currents, $t_p = 10\text{ms}$

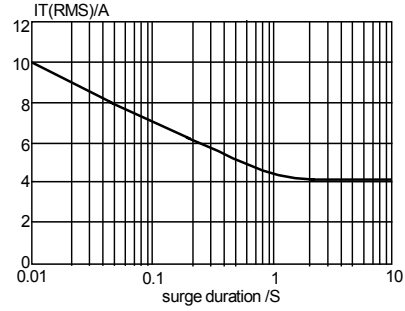

Fig. 5. Maximum permissible repetitive rms on-state current $I_{T(RMS)}$, versus surge duration, for sinusoidal currents, $f=50\text{Hz}$; $T_{mb} \leq 113^\circ\text{C}$

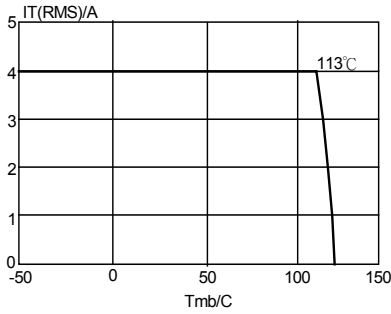

Fig. 3. Maximum permissible rms current $I_{T(RMS)}$, versus mounting base temperature T_{mb}

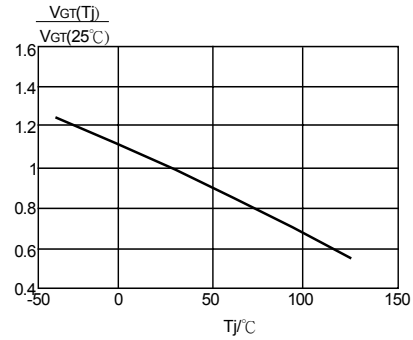

Fig. 6. Normalised gate trigger voltage $V_{Gt}(T_j) / V_{Gt}(25^\circ\text{C})$, versus junction temperature T_j

UTC BT150

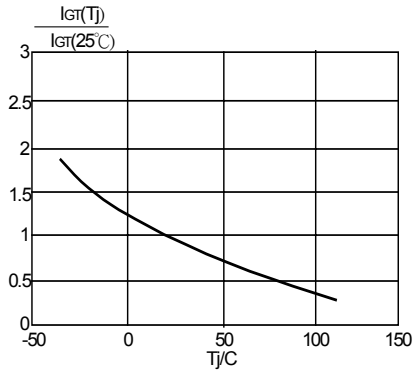

Fig. 7. Normalised gate trigger Current $I_{gr}(T_j)/I_{gr}(25^\circ\text{C})$, versus junction temperature T_j

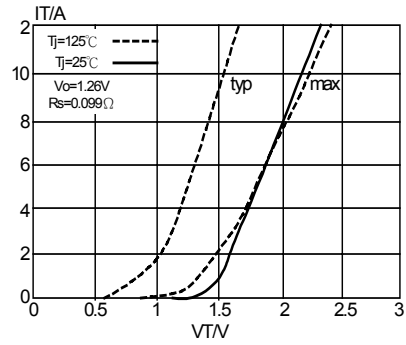

Fig. 10. Typical and maximum on-state characteristic.

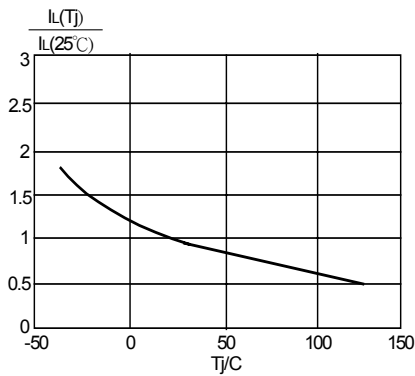

Fig. 8. Normalised latching Current $I_l(T_j)/I_l(25^\circ\text{C})$, versus junction temperature T_j

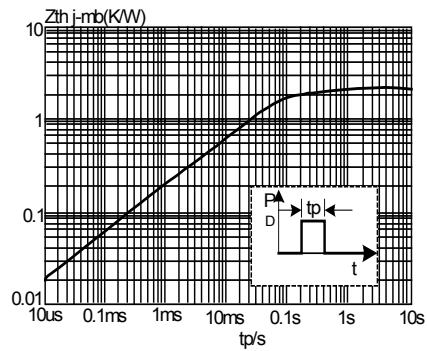

Fig. 11. Transient thermal impedance Z_{thj-mb} , versus pulse width t_p .

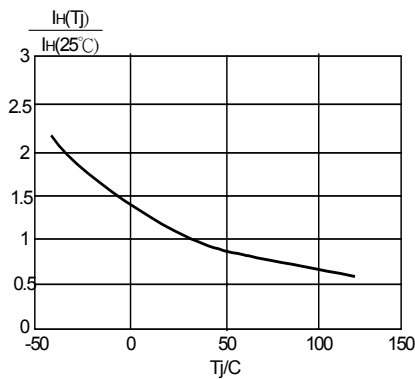

Fig. 9. Normalised holding current $I_h(T_j)/I_h(25^\circ\text{C})$, versus junction temperature T_j

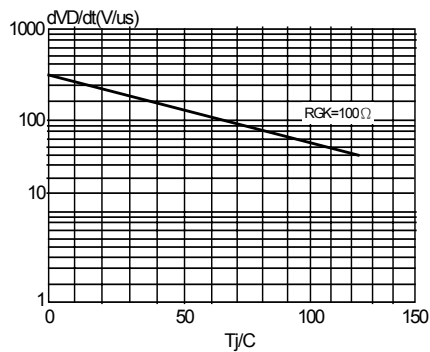

Fig. 12. Typical, critical rate of rise of off-state voltage, dV_d/dt versus junction temperature T_j .

UTC assumes no responsibility for equipment failures that result from using products at values that exceed, even momentarily, rated values (such as maximum ratings, operating condition ranges, or other parameters) listed in products specifications of any and all UTC products described or contained herein. UTC products are not designed for use in life support appliances, devices or systems where malfunction of these products can be reasonably expected to result in personal injury. Reproduction in whole or in part is prohibited without the prior written consent of the copyright owner. The information presented in this document does not form part of any quotation or contract, is believed to be accurate and reliable and may be changed without notice.