

Sensitive Gate Triacs

Features

- ◆ Repetitive Peak Off-State Voltage : 600V
- ◆ R.M.S On-State Current ($I_{T(RMS)}= 6 A$)
- ◆ High Commutation dv/dt
- ◆ Sensitive Gate Triggering 4 Mode
- ◆ Non-isolated Type

General Description

This device is sensitive gate triac suitable for direct coupling to TTL, HTL, CMOS and application such as various logic functions, AC switching applications, phase control application such as fan speed, light controllers and home appliance equipment.

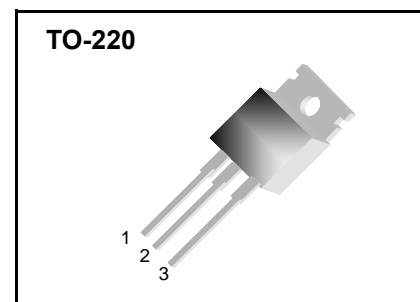
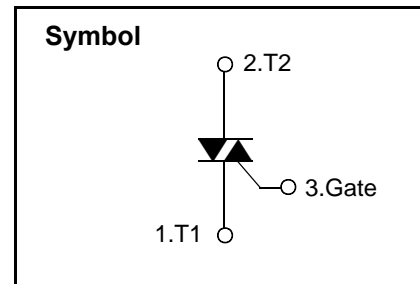

Absolute Maximum Ratings ($T_J = 25^{\circ}C$ unless otherwise specified)

Symbol	Parameter	Condition	Ratings	Units
V_{DRM}	Repetitive Peak Off-State Voltage	Sine wave, 50 to 60 Hz, Gate open	600	V
$I_{T(RMS)}$	R.M.S On-State Current	$T_C = 101^{\circ}C$, Full Sine wave	6.0	A
I_{TSM}	Surge On-State Current	One Cycle, 50Hz/60Hz, Peak, Non-Repetitive	60/66	A
I^2t	I^2t for Fusing	$t_p = 10ms$	18	A^2s
P_{GM}	Peak Gate Power Dissipation	$T_C = 101^{\circ}C$, Pulse width $\leq 1.0\mu s$	3.0	W
$P_{G(AV)}$	Average Gate Power Dissipation	Over any 20ms period	0.3	W
I_{GM}	Peak Gate Current	$t_p = 20\mu s, T_J = 125^{\circ}C$	2.0	A
V_{GM}	Peak Gate Voltage	$t_p = 20\mu s, T_J = 125^{\circ}C$	10	V
T_J	Operating Junction Temperature		- 40 ~ 125	$^{\circ}C$
T_{STG}	Storage Temperature		- 40 ~ 150	$^{\circ}C$

BT236-D

Electrical Characteristics

Symbol	Items		Conditions	Ratings			Unit
				Min.	Typ.	Max.	
I_{DRM}	Repetitive Peak Off-State Current		$V_D = V_{DRM}$, Single Phase, Half Wave $T_J = 125\text{ }^\circ\text{C}$	—	—	1.0	mA
V_{TM}	Peak On-State Voltage		$I_T = 8\text{ A}$, Inst. Measurement	—	—	1.6	V
I_{GT1}^+	I	Gate Trigger Current	$V_D = 6\text{ V}$, $R_L = 10\text{ }\Omega$	—	—	5	mA
I_{GT1}^-	II			—	—	5	
I_{GT3}^-	III			—	—	5	
I_{GT3}^+	IV			—	8	12	
V_{GT1}^+	I	Gate Trigger Voltage	$V_D = 6\text{ V}$, $R_L = 10\text{ }\Omega$	—	—	1.4	V
V_{GT1}^-	II			—	—	1.4	
V_{GT3}^-	III			—	—	1.4	
V_{GT3}^+	IV			—	1.6	2.0	
V_{GD}	Non-Trigger Gate Voltage		$T_J = 125\text{ }^\circ\text{C}$, $V_D = 1/2 V_{DRM}$	0.2	—	—	V
$(dv/dt)_c$	Critical Rate of Rise Off-State Voltage at Commutation		$T_J = 125\text{ }^\circ\text{C}$, $[di/dt]_c = -0.5\text{ A/ms}$, $V_D = 2/3 V_{DRM}$	5	—	—	V/ μs
I_H	Holding Current			—	—	10	mA
$R_{th(j-c)}$	Thermal Impedance		Junction to case	—	—	2.8	$^\circ\text{C/W}$
$R_{th(j-a)}$	Thermal Impedance		Junction to Ambient	—	—	60	$^\circ\text{C/W}$

※ Notes :

1. Pulse Width $\leq 300\mu\text{s}$, Duty cycle $\leq 2\%$



Fig 1. Gate Characteristics

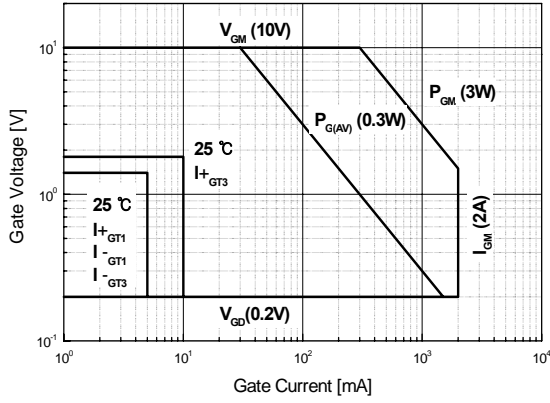

Fig 2. On-State Voltage

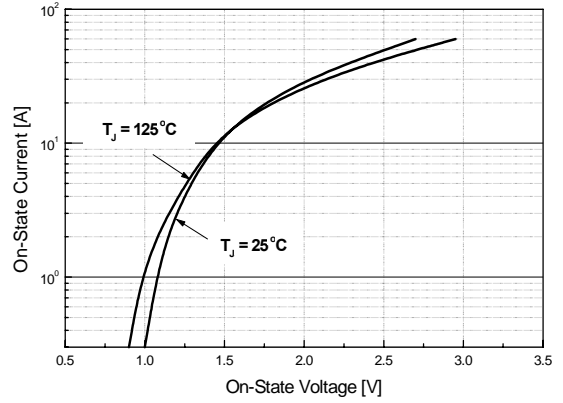

Fig 3. On State Current vs. Maximum Power Dissipation

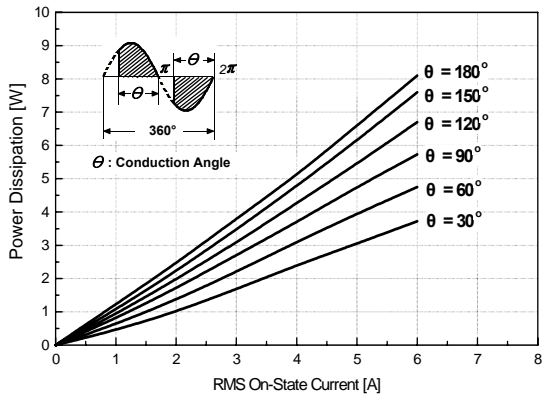

Fig 4. On State Current vs. Allowable Case Temperature

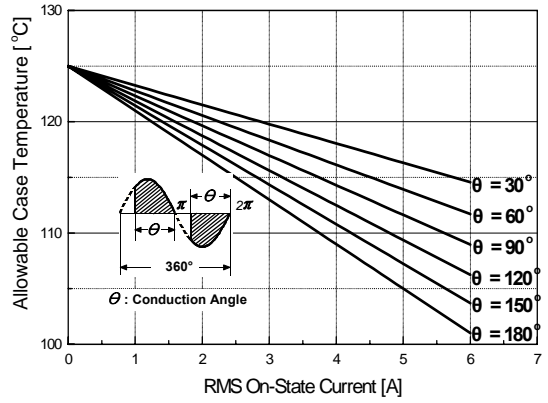

Fig 5. Surge On-State Current Rating (Non-Repetitive)

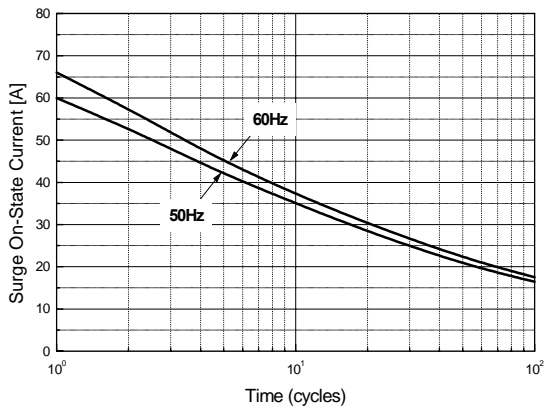
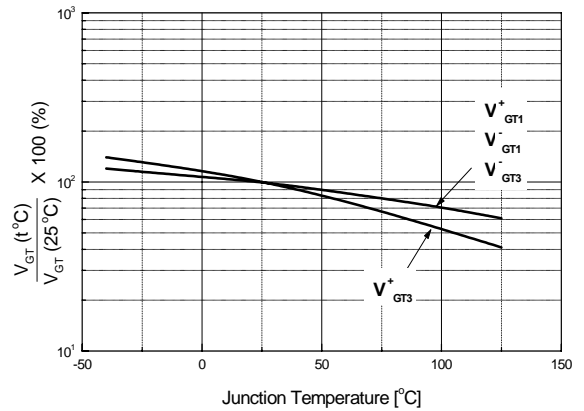

Fig 6. Gate Trigger Voltage vs. Junction Temperature



BT236-D

Fig 7. Gate Trigger Current vs. Junction Temperature

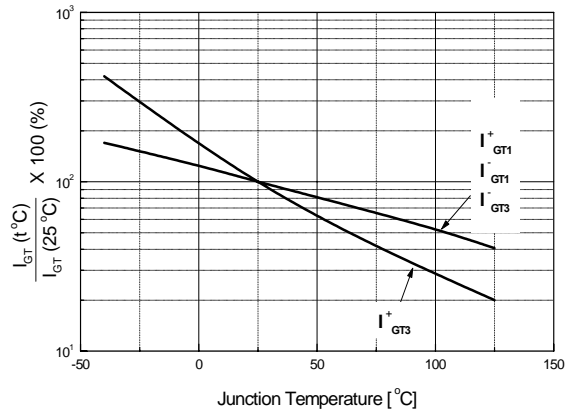

Fig 8. Transient Thermal Impedance

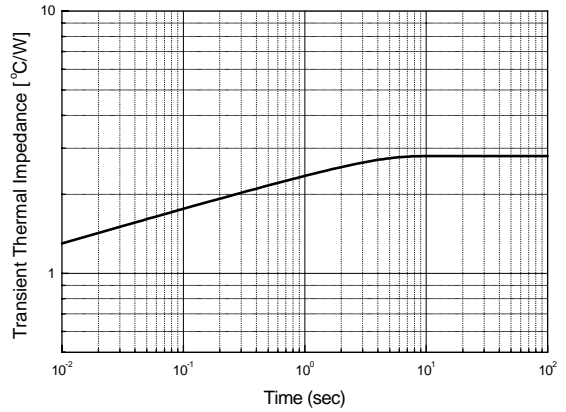
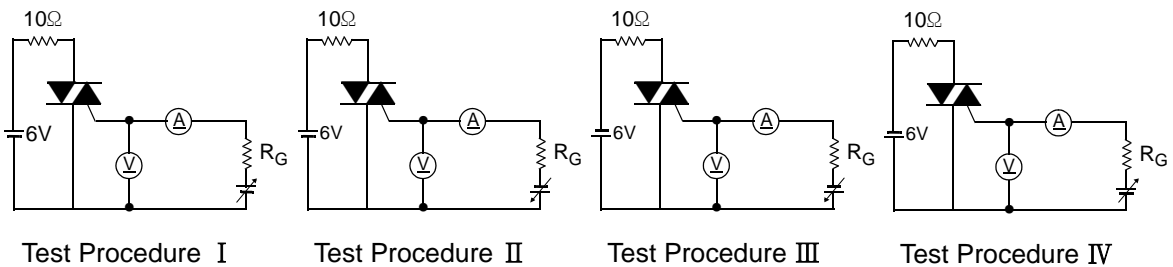

Fig 9. Gate Trigger Characteristics Test Circuit



TO-220 Package Dimension

Dim.	mm			Inch		
	Min.	Typ.	Max.	Min.	Typ.	Max.
A	9.7		10.1	0.382		0.398
B	6.3		6.7	0.248		0.264
C	9.0		9.47	0.354		0.373
D	12.8		13.3	0.504		0.524
E	1.2		1.4	0.047		0.055
F		1.7			0.067	
G		2.5			0.098	
H	3.0		3.4	0.118		0.134
I	1.25		1.4	0.049		0.055
J	2.4		2.7	0.094		0.106
K	5.0		5.15	0.197		0.203
L	2.2		2.6	0.087		0.102
M	1.25		1.55	0.049		0.061
N	0.45		0.6	0.018		0.024
O	0.6		1.0	0.024		0.039
ϕ		3.6			0.142	

