



BTA04/BTB04 Series/T4 Series 4A TRIACs

DESCRIPTION:

High current density due to double mesa technology; Glass Passivation.

BTA04/BTB04 series triacs is suitable for general purpose AC switching. They can be used as an ON/OFF Function in applications such as static relays, heating regulation, induction motor starting circuits... or for phase control operation light dimmers, motor speed controllers.

T4×× Series are 3 Quadrants triacs, They are specially recommended for use on inductive loads.

The T0-220AB ins Family are 2500V RMS insulating voltage.

MAIN FEATURES

Symbol	Value	Unit
$I_{T(RMS)}$	4	A
V_{DRM}/V_{RRM}	600 and 800	V
$I_{GT}(Q1)$	5 to 35	mA

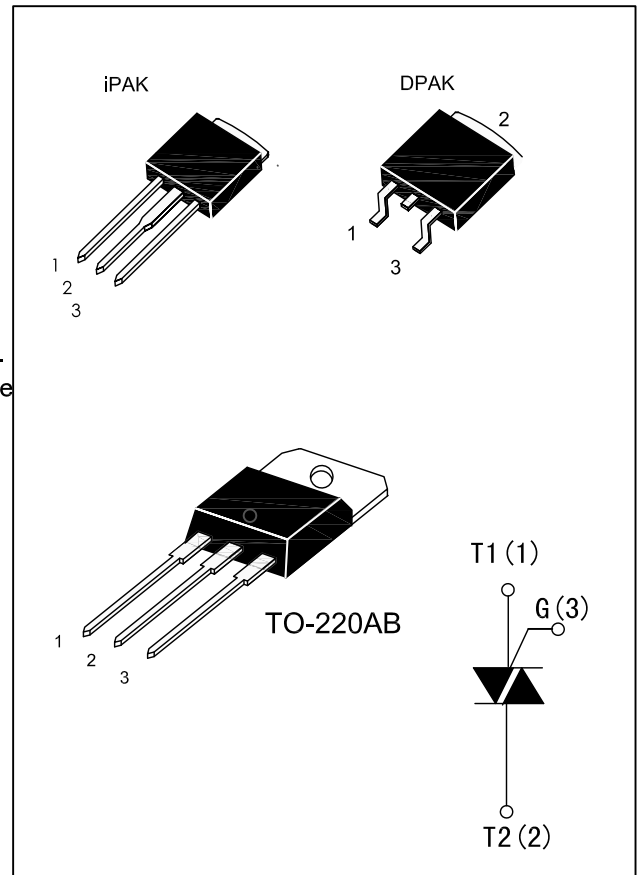

ABSOLUTE MAXIMUM RATINGS

Parameter		Symbol	Value	Unit
Storage junction temperature range		Tstg	-40 to +150	°C
Operating junction temperature range		Tj	-40 to +125	°C
Repetitive Peak Off-state Voltage	Tj=25°C	VDRM	600and800	V
Repetitive Peak Reverse Voltage	Tj=25°C	VRRM	600and800	
Non repetitive Surge Peak Off-state Voltage	tp=10ms, Tj=25°C	VDSM	700and900	V
Non repetitive Peak Reverse Voltage		VRSM	700and900	
RMS on-state current (full sine wave)	iPAK/DPAK/TO-220AB Tc=105°C	IT(RMS)	4	A
	TO-220AB ins Tc=100°C			
Non repetitive surge peak on-state current (full cycle, Tj=25°C)	f = 60 Hz t=16.7ms	ITSM	38	A
	f = 50 Hz t=20ms		35	
I²t Value for fusing	tp=10ms	I²t	6	A²s
Critical rate of rise of on-state current IG=2×IGT, tr≤100 ns, f=120Hz, Tj=125°C		di /dt	50	A/μs
Peak gate current	tp=20us, Tj=125°C	IGM	4	A
Average gate power dissipation	Tj=125°C	PG(AV)	1	W

ELECTRICAL CHARACTERISTICS($T_j=25^\circ\text{C}$ unless otherwise specified)

● BTA04/JBTB04 Series

Symbol	Test Condition	Quadrant		BTA04/BTB04				Unit
				T	D	S	A	
IGT	$V_D=12\text{V}$ $R_L=33\Omega$	I-II-III IV	MAX.	5 5	5 10	10 10	10 25	mA
VGT		ALL	MAX.	1.5				V
VGD	$V_D=V_{DRM}$ $R_L=3.3\text{K}\Omega$ $T_j=125^\circ\text{C}$	ALL	MIN.	0.2				V
IL	$I_G=1.2I_{GT}$	I-III-IV	MAX.	10	10	20	20	mA
		II	MAX.	20	20	40	40	mA
IH	$I_T=500\text{mA}$		MAX.	15	15	25	25	mA
dV/dt	$V_D=67\%V_{DRM}$ gate open $T_j=125^\circ\text{C}$		MIN.	10	10	10	10	V/ μs
(dV/dt)c	$(dI/dt)_c=1.8\text{A/ms}$ $T_j=125^\circ\text{C}$		MIN.	1	1	5	5	V/ μs

● T4 Series

Symbol	Test Condition	Quadrant		T4			Unit
				T405	T410	T435	
IGT	$V_D=12\text{V}$ $R_L=33\Omega$	I-II-III	MAX.	5	10	35	mA
VGT		I-II-III	MAX.	1.3			V
VGD	$V_D=V_{DRM}$ $R_L=3.3\text{K}\Omega$ $T_j=125^\circ\text{C}$	I-II-III	MIN.	0.2			V
IL	$I_G=1.2I_{GT}$	I-III	MAX.	10	25	50	mA
		II	MAX.	15	30	60	mA
IH	$I_T=500\text{mA}$		MAX.	10	15	35	mA
dV/dt	$V_D=67\%V_{DRM}$ gate open $T_j=125^\circ\text{C}$		MIN.	20	40	400	V/ μs
(dI/dt)c	$(dV/dt)_c=0.1\text{V}/\mu\text{s}$ $T_j=125^\circ\text{C}$		MIN.	1.8	2.7	---	A/ms
	$(dV/dt)_c=10\text{V}/\mu\text{s}$ $T_j=125^\circ\text{C}$			0.9	2.0	---	
	Without snubber $T_j=125^\circ\text{C}$			---	---	2.5	

STATIC CHARACTERISTICS

Symbol	Parameter		Value(MAX.)	Unit
V _{TM}	I _{TM} =5.5A, t _p =380μs	T _j =25°C	1.6	V
I _{DRM} I _{RRM}	V _D =V _{DRM} V _R =V _{RRM}	T _j =25°C	5	μA
		T _j =125°C	1	mA

THERMAL RESISTANCES

Symbol	Parameter		Value	Unit
R _{th} (J -C)	Junction to Case(AC)	iAPK/DPAK/TO-220AB	2.6	°C/W
		TO-220AB ins	4.0	

ORDERING INFORMATION

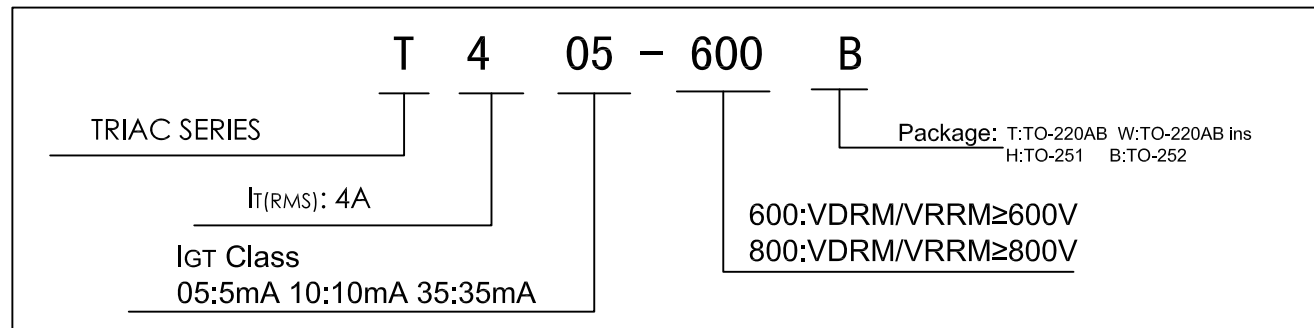
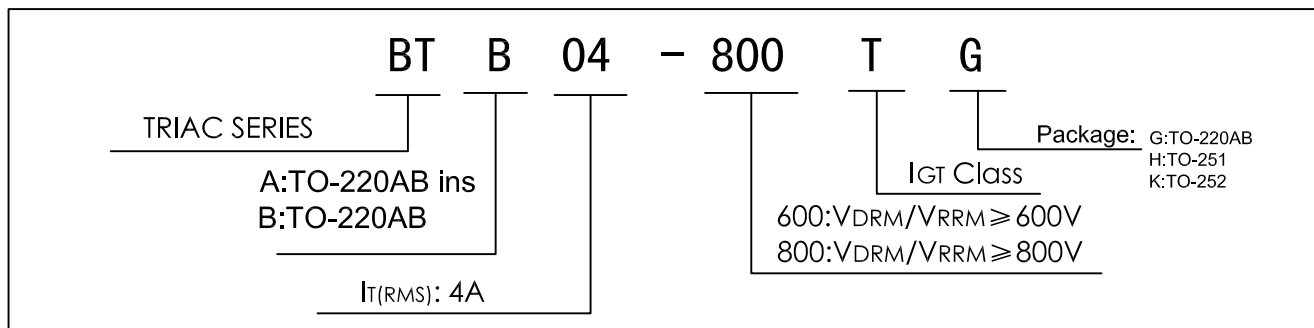

PACKAGE MECHANICAL DATA

iPAK

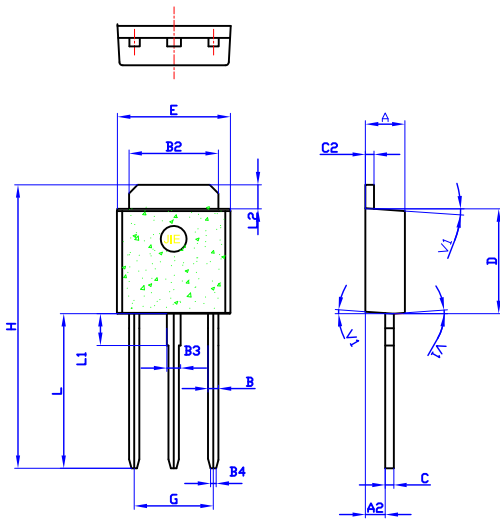

Ref.	Dimensions					
	Millimeters			Inches		
	Min.	Typ.	Max.	Min.	Typ.	Max.
A	2.2		2.4	0.086		0.095
A2	0.9		1.1	0.035		0.043
B	0.55		0.65	0.021		0.026
B2	5.1		5.4	0.200		0.212
B3	0.76		0.85	0.030		0.033
B4		0.32			0.013	
C	0.45		0.62	0.017		0.024
C2	0.48		0.62	0.019		0.024
D	6		6.2	0.236		0.244
E	6.4		6.7	0.252		0.264
G	4.4		4.7	0.173		0.185
H	16.0		16.7	0.630		0.658
L	8.9		9.4	0.350		0.370
L1	1.8		1.9	0.071		0.075
L2	1.37		1.5	0.054		0.059
V1		4°			4°	

DPAK

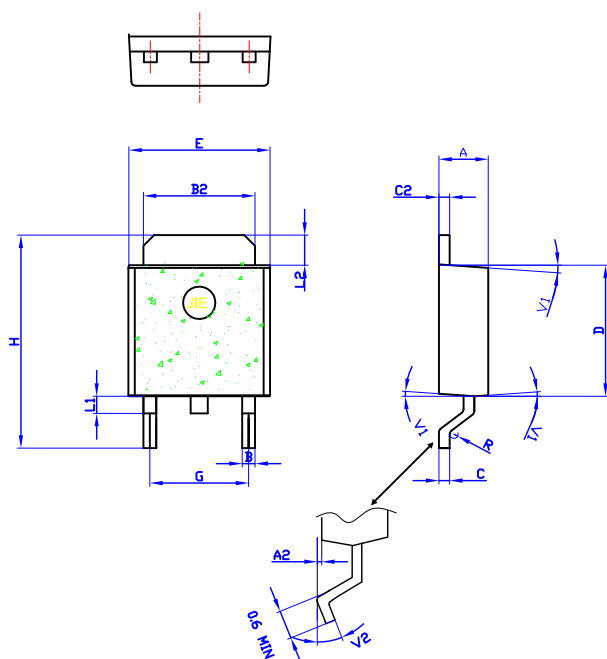

Ref.	Dimensions					
	Millimeters			Inches		
	Min.	Typ.	Max.	Min.	Typ.	Max.
A	2.2		2.4	0.086		0.095
A2	0.03		0.23	0.001		0.009
B	0.55		0.65	0.021		0.026
B2	5.1		5.4	0.200		0.212
C	0.45		0.62	0.017		0.024
C2	0.48		0.62	0.019		0.024
D	6		6.2	0.236		0.244
E	6.4		6.7	0.252		0.264
G	4.40		4.70	0.173		0.185
H	9.35		10.1	0.368		0.397
L1		0.8			0.031	
L2	1.37		1.5	0.054		0.059
V1		4°			4°	
V2	0°		8°	0°		8°

PACKAGE MECHANICAL DATA

TO-220AB

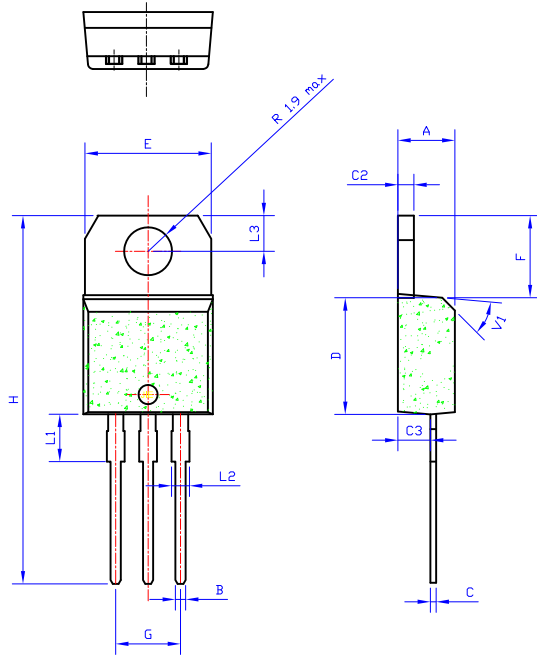

Ref.	Dimensions					
	Millimeters			Inches		
	Min.	Typ.	Max.	Min.	Typ.	Max.
A	4.4		4.6	0.173		1.181
B	0.61		0.88	0.024		0.034
C	0.46		0.70	0.018		0.027
C2	1.23		1.32	0.048		0.051
C3	2.4		2.72	0.094		0.107
D	8.6		9.7	0.338		0.382
E	9.8		10.4	0.386		0.409
F	6.2		6.6	0.244		0.259
G	4.8		5.4	0.189		0.213
H	28.0		29.8	11.0		11.7
L1		3.75			0.147	
L2	1.14		1.7	0.044		0.066
L3	2.65		2.95	0.104		0.116
V1		40°			40°	

FIG.1: Maximum power dissipation versus RMS on-state current(full cycle)

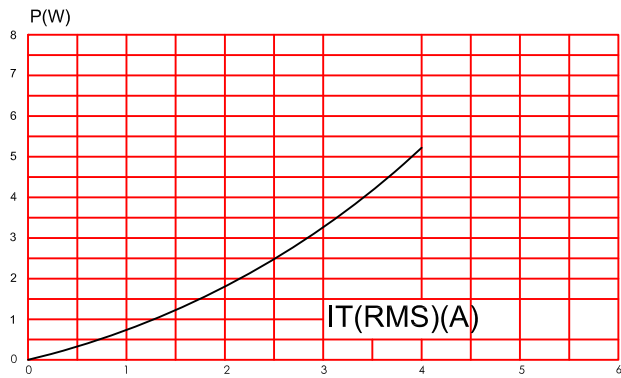

FIG.2: RMS on-state current versus case temperature(full cycle)

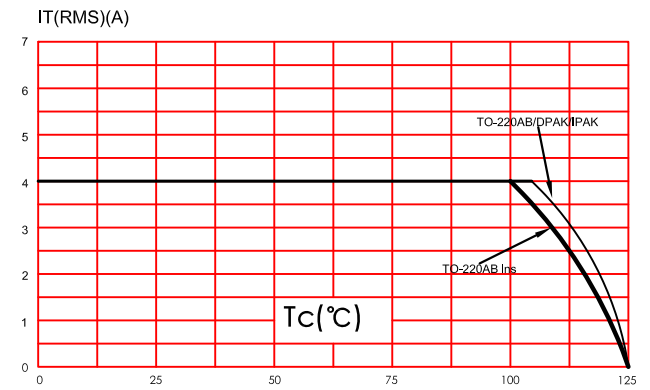

FIG.3: On-state characteristics (maximum values)

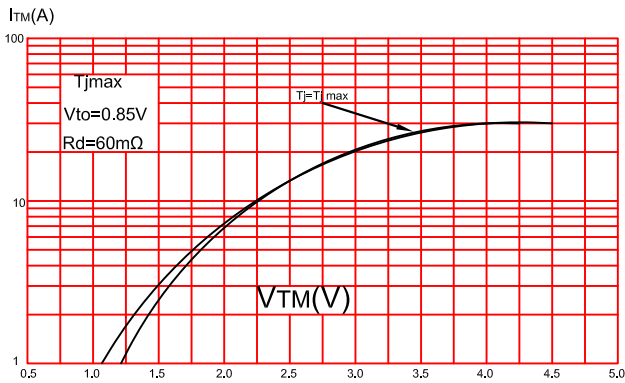

FIG.4: Surge peak on-state current versus number of cycles

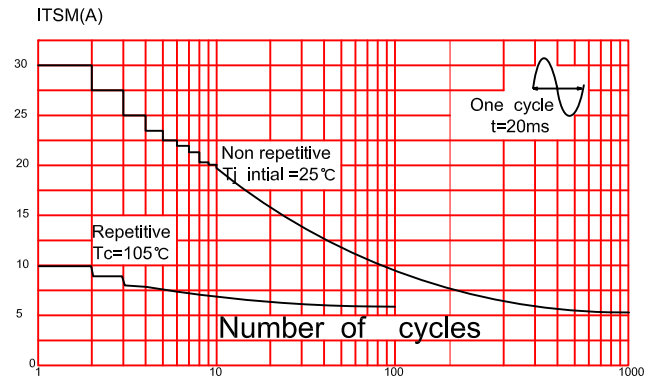

FIG.5: Non-repetitive surge peak on-state current for a sinusoidal pulse with width $t_p < 10\text{ms}$.

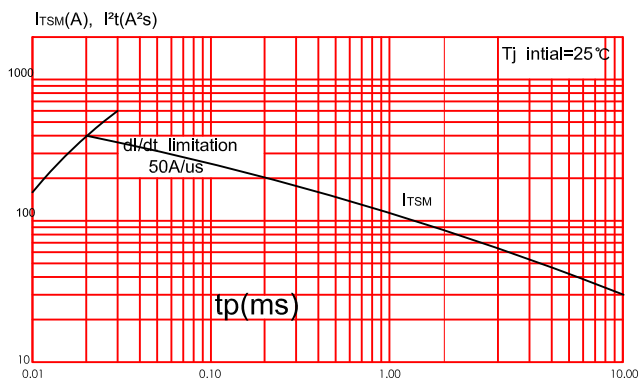

FIG.6: Relative variations of gate trigger current, holding current and latching current versus junction temperature(typical values)

