

CMOS LDO Regulator Series for Portable Equipments

Versatile Package

FULL CMOS LDO Regulator

BUxxUC3WG series

●General Description

BUxxUC3WG series is high-performance FULL CMOS regulator with 300-mA output, which is mounted on versatile package SSOP5 (2.9 mm × 2.8 mm × 1.25 mm). It has excellent noise characteristics and load responsiveness characteristics despite its low circuit current consumption of 50μA. It is most appropriate for various applications such as power supplies for logic IC, RF, and camera modules ROHM's.

●Features

- High accuracy detection
- low current consumption
- Compatible with small ceramic capacitor (Cin=Co=1.0uF)
- With built-in output discharge circuit
- High ripple rejection
- ON/OFF control of output voltage
- With built-in over current protection circuit and thermal shutdown circuit
- Package SSOP5 is similar to SOT-23-5 (JEDEC)
- Low dropout voltage

●Key Specifications

- Output voltage: 1.0V to 3.3V
- Accuracy output voltage: ±1.0% (±25mV)
- Low current consumption: 50μA
- Operating temperature range: -40°C to +85°C

●Applications

Battery-powered portable equipment, etc.

●Package

SSOP5: 2.90mm x 2.80mm x 1.25mm



●Typical Application Circuit

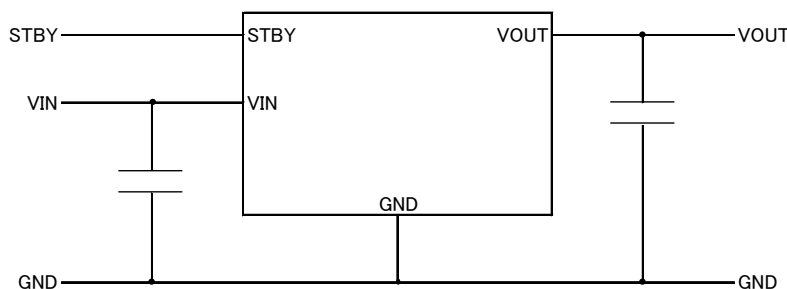
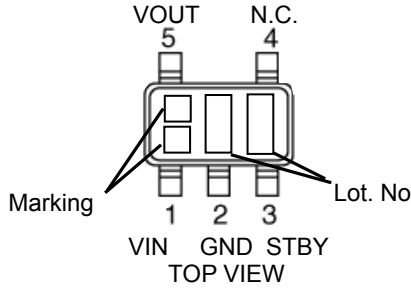

Figure 1. Application Circuit

● Connection Diagram
SSOP5



● Pin Descriptions

SSOP5		
PIN No.	Symbol	Function
1	VIN	Power Supply Voltage
2	GND	Grounding
3	STBY	ON/OFF control of output voltage (High: ON, Low: OFF)
4	N.C.	Unconnected Terminal
5	VOUT	Output Voltage

● Ordering Information

B U x x U C 3 W G - x x

Part Number	Output Voltage 10 : 1.0V ↓ 33 : 3.3V	Low Dropout Voltage Maximum Output Current 300mA	with switch	Package G : SSOP5	Packaging and forming specification Embossed tape and reel TR : The pin number 1 is the upper right TL : The pin number 1 is the lower left
-------------	---	--	-------------	----------------------	--

SSOP5

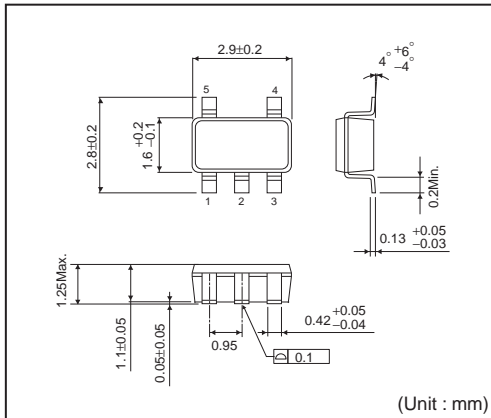

< Tape and Reel Information >

Tape	Embossed carrier tape
Quantity	3000pcs
Direction of feed	TR [The direction is the 1pin of product is at the upper right when you hold reel on the left hand and you pull out the tape on the right hand]

< Tape and Reel Information >

Tape	Embossed carrier tape
Quantity	3000pcs
Direction of feed	TL [The direction is the 1pin of product is at the lower left when you hold reel on the left hand and you pull out the tape on the right hand]

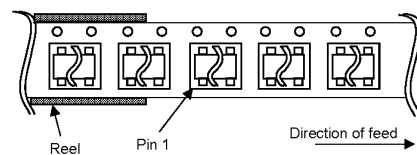
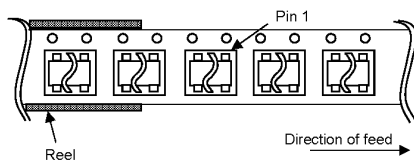

●Lineup

Marking	Q0	Q2	Q8	R6	Y0	Y6	Y7
Output Voltage	1.0V	1.1V	1.8V	2.5V	2.8V	3.2V	3.3V
Part Number	BU10	BU11	BU18	BU25	BU28	BU32	BU33

●Absolute Maximum Ratings (Ta=25°C)

PARAMETER	Symbol	Limit	Unit
Power Supply Voltage	VMAX	-0.3 ~ +6.0	V
Power Dissipation	Pd	540(*1)	mW
Maximum junction temperature	TjMAX	+125	°C
Operating Temperature Range	Topr	-40 ~ +85	°C
Storage Temperature Range	Tstg	-55 ~ +125	°C

(*1)Pd deleted at 5.4mW/°C at temperatures above Ta=25°C, mounted on 70×70×1.6 mm glass-epoxy PCB.

●RECOMMENDED OPERATING RANGE (not to exceed Pd)

PARAMETER	Symbol	Limit	Unit
Power Supply Voltage	VIN	1.7~5.5	V
Maximum Output Current	IMAX	300	mA

●OPERATING CONDITIONS

PARAMETER	Symbol	MIN.	TYP.	MAX.	Unit	CONDITION
Input Capacitor	Cin	0.47(*2)	1.0	-	μF	Ceramic capacitor recommended
Output Capacitor	Co	0.47(*2)	1.0	-	μF	

(*2)Make sure that the output capacitor value is not kept lower than this specified level across a variety of temperature and DC bias characteristic.

●Electrical Characteristics

(Ta=25°C, VIN=VOUT+1.0V (*3), STBY=VIN, Cin=1.0μF, Co=1.0μF, unless otherwise noted.)

PARAMETER	Symbol	Limit			Unit	Conditions	
		MIN.	TYP.	MAX.			
Overall Device							
Output Voltage	VOUT	VOUT×0.99	VOUT	VOUT×1.01	V	IOUT=10 μ A, VOUT ≥ 2.5V	
		VOUT-25mV		VOUT+25mV		IOUT=10 μ A, VOUT < 2.5V	
Operating Current	IIN	-	50	90	μ A	IOUT=0mA	
Operating Current (STBY)	ISTBY	-	-	1.0	μ A	STBY=0V	
Ripple Rejection Ratio	RR	45	70	-	dB	VRR=-20dBv, fRR=1kHz, IOUT=10mA, VIN=3.6V	
Dropout Voltage	VSAT	-	470	700	mV	1.0V ≤ VOUT < 1.2V (IOUT=300mA)	
		-	350	500	mV	1.2V ≤ VOUT < 1.5V (IOUT=300mA)	
		-	280	380	mV	1.5V ≤ VOUT < 1.7V (IOUT=300mA)	
		-	250	320	mV	1.7V ≤ VOUT < 2.1V (IOUT=300mA)	
		-	220	260	mV	2.1V ≤ VOUT < 2.5V (IOUT=300mA)	
		-	200	220	mV	2.5V ≤ VOUT (IOUT=300mA)	
Line Regulation	VDL	-	2	20	mV	VIN=VOUT+1.0V to 5.5V(*4), IOUT=10μA	
Load Regulation	VDLO	-	25	45	mV	IOUT=0.01mA to 300mA	
Over-current Protection (OCP)							
Limit Current	ILMAX	370	550	-	mA	Vo=VOUT*0.95	
Short Current	ISHORT	50	150	300	mA	Vo=0V	
Standby Block							
Discharge Resistor	RDSC	20	50	80	Ω	VIN=5.5V, STBY=0V, VOUT=2.6V	
STBY Pin Pull-down Current	ISTB	0.1	0.9	8.0	μ A	STBY=1.5V	
STBY Control Voltage	ON	VSTBH	1.2	-	5.5	V	
	OFF	VSTBL	-0.3	-	0.3	V	

○This product is not designed for protection against radioactive rays.

(*3) VIN=2.5V for VOUT ≤ 1.5V

(*4) VIN=2.5V to 3.6V for VOUT ≤ 1.5V

●Block Diagrams

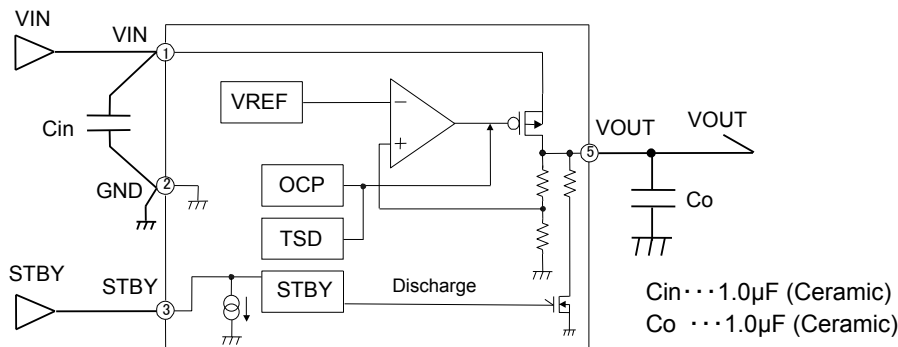

Figure 2. Block Diagrams

● Reference data **BU10UC3WG** (Ta=25°C unless otherwise specified.)

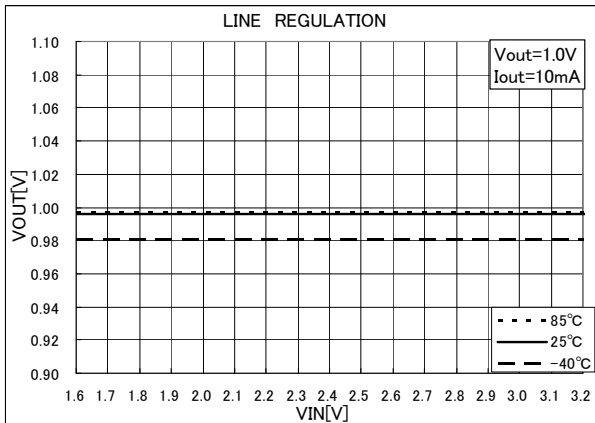

Figure 3.

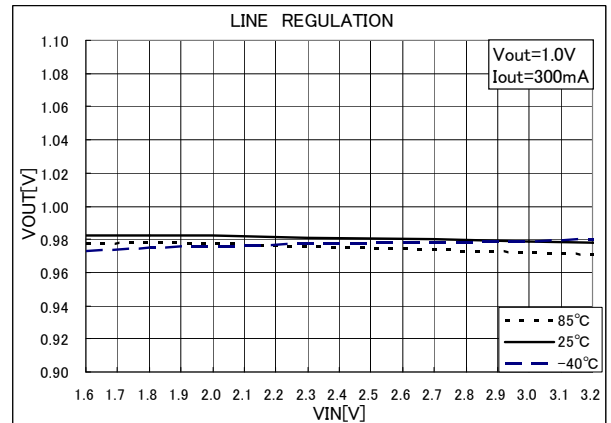

Figure 4.

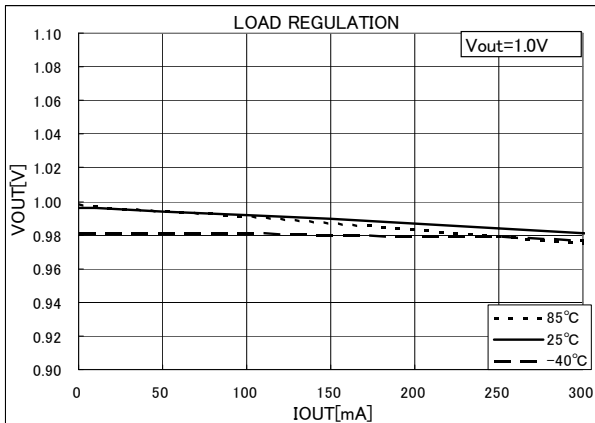

Figure 5.

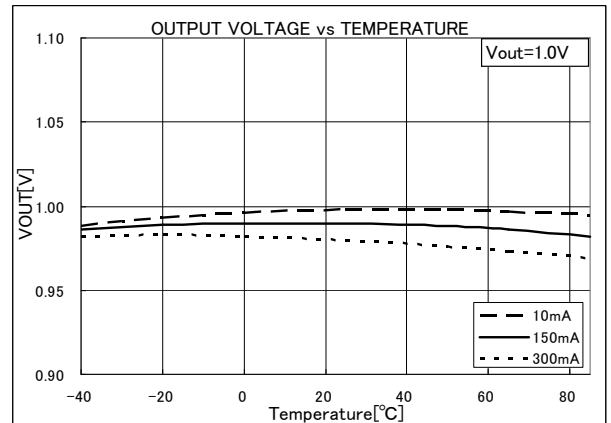

Figure 6.

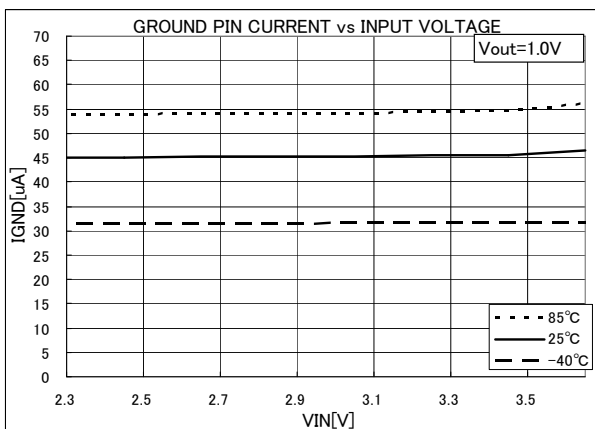

Figure 7.

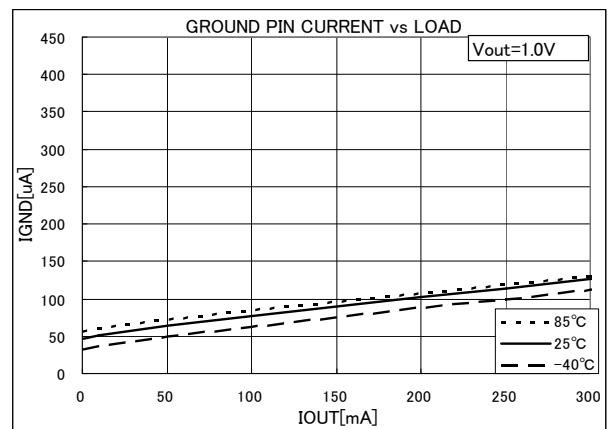

Figure 8.

● Reference data **BU10UC3WG** (Ta=25°C unless otherwise specified.)

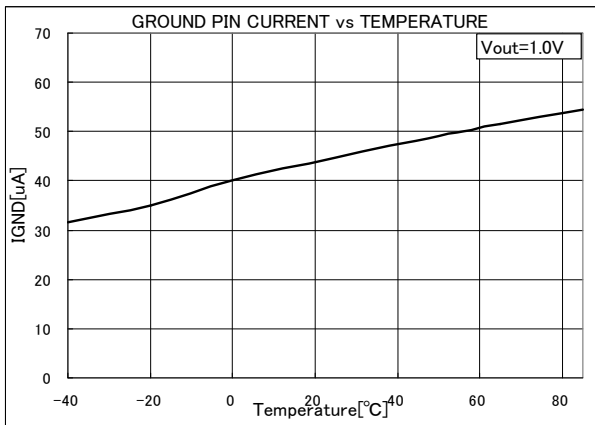

Figure 9.

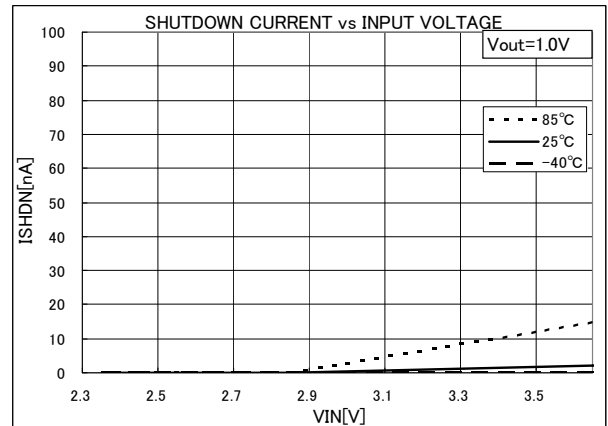

Figure 10.

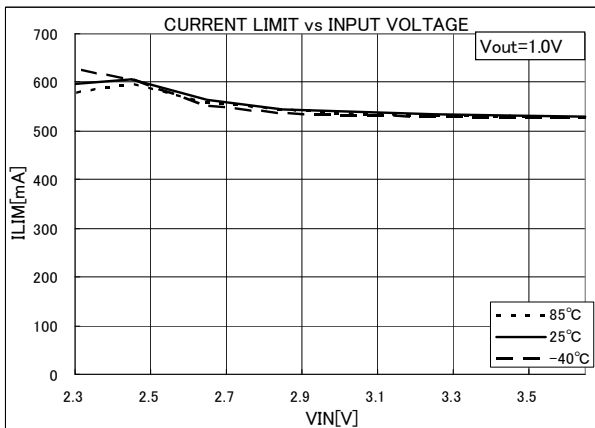

Figure 11.

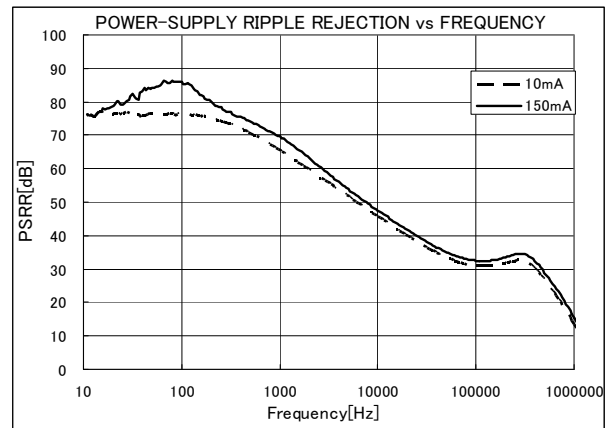

Figure 12.

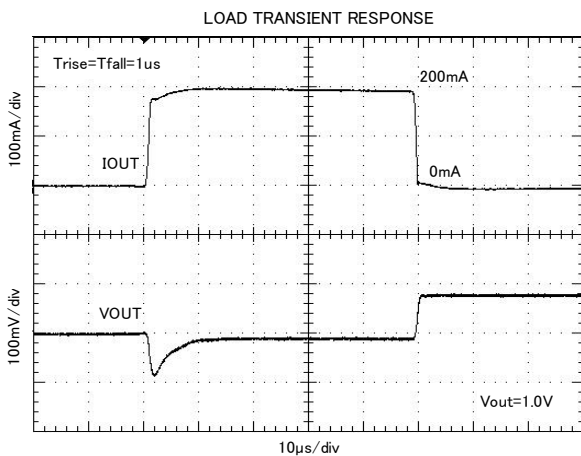

Figure 13.

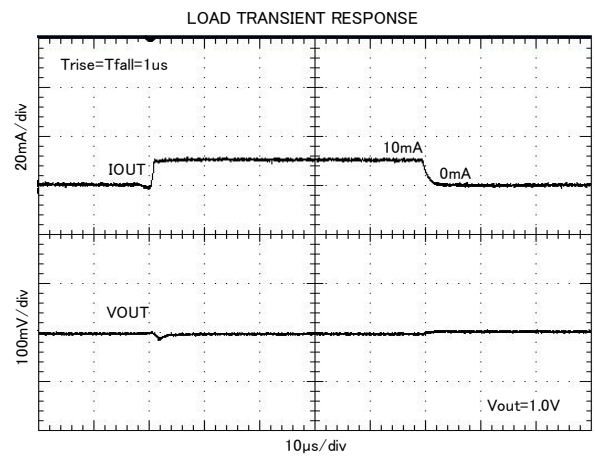

Figure 14.

● Reference data **BU10UC3WG** (Ta=25°C unless otherwise specified.)

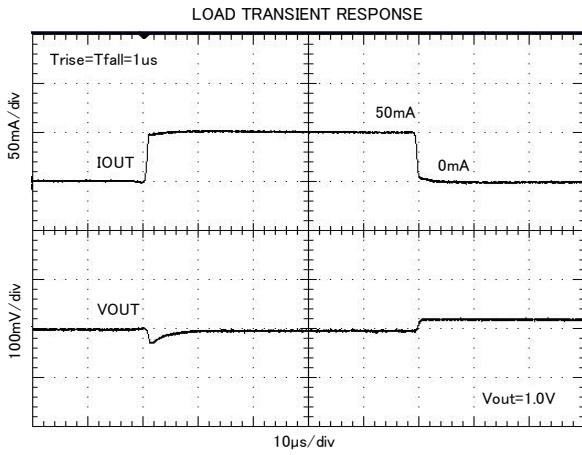

Figure 15.

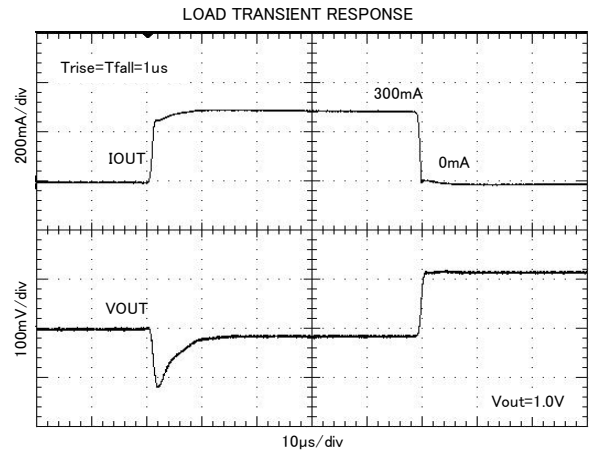

Figure 16.

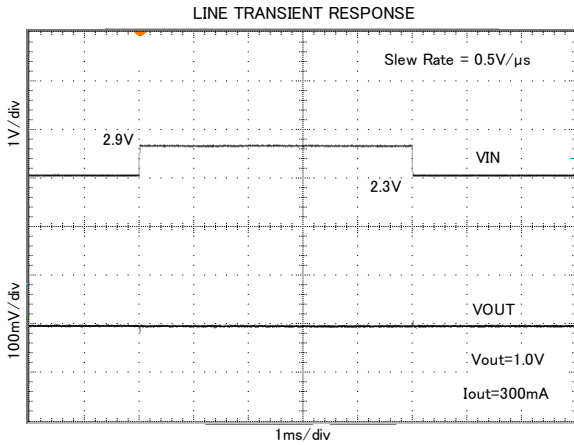

Figure 17.

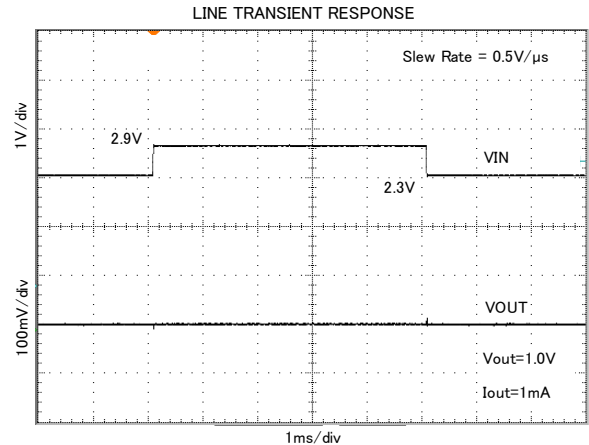

Figure 18.

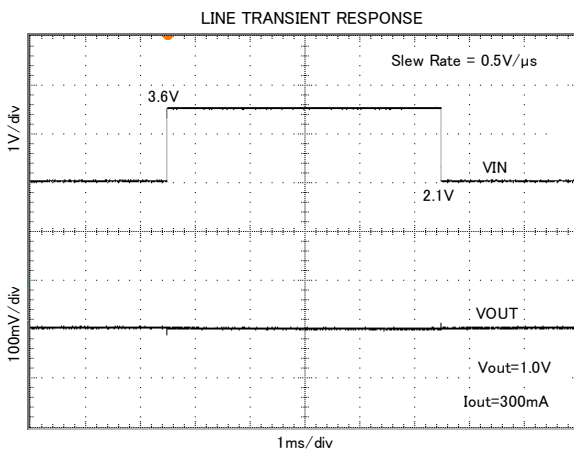

Figure 19.

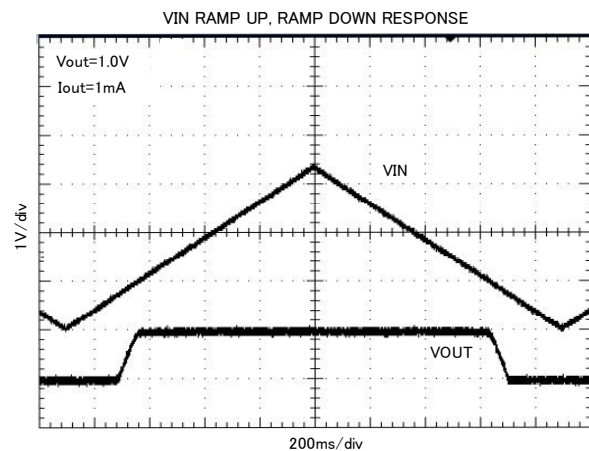

Figure 20.

● Reference data **BU10UC3WG** (Ta=25°C unless otherwise specified.)

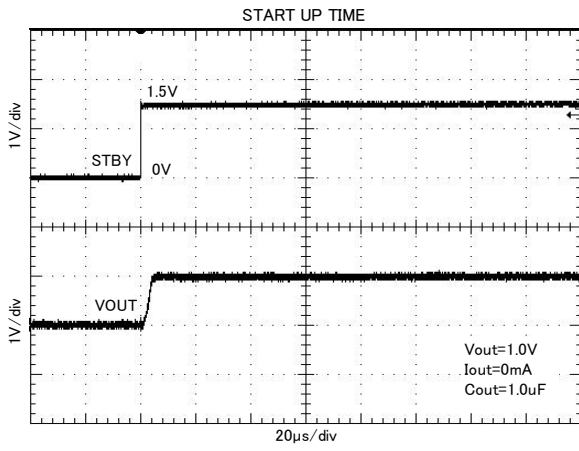

Figure 21.

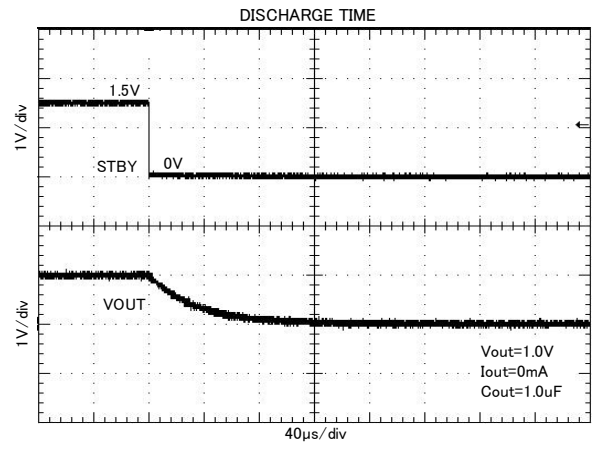

Figure 22.

● Reference data **BU11UC3WG** (Ta=25°C unless otherwise specified.)

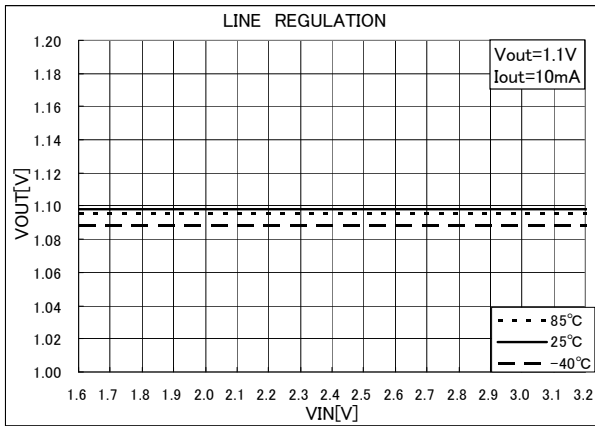

Figure 23.

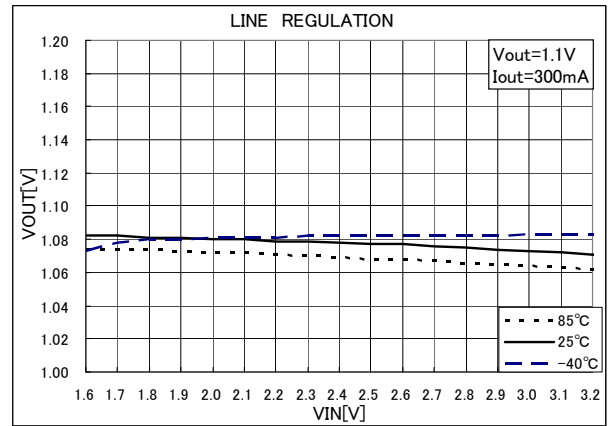

Figure 24.

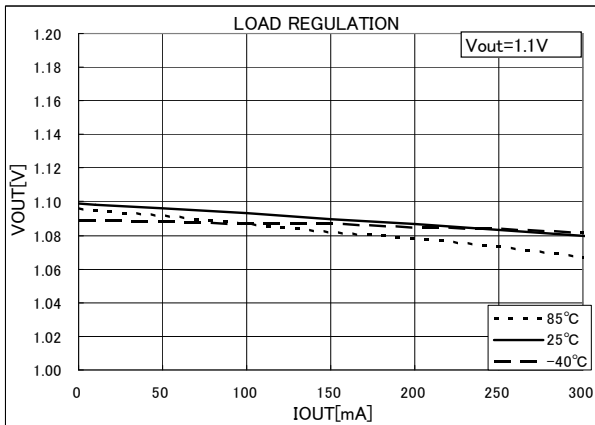

Figure 25.

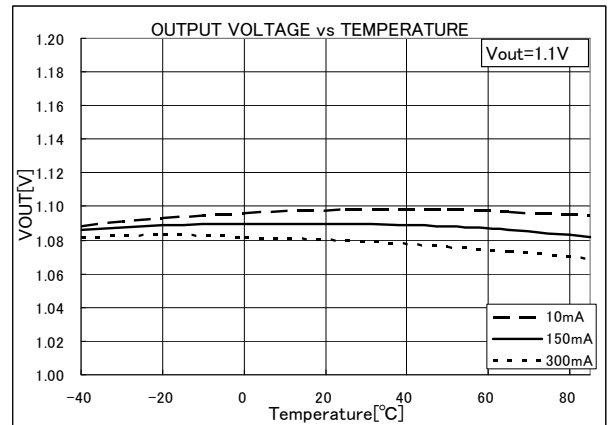

Figure 26.

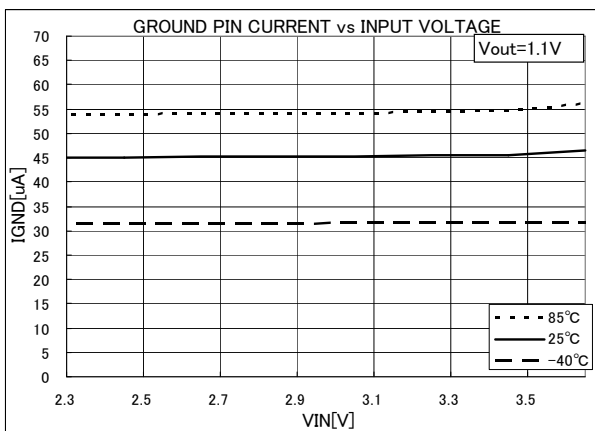

Figure 27.

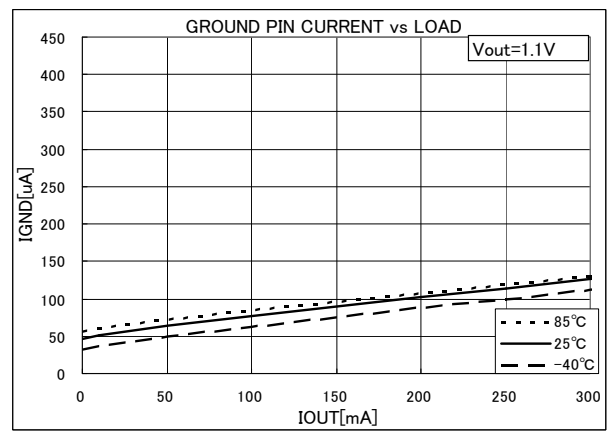

Figure 28.

● Reference data **BU11UC3WG** (Ta=25°C unless otherwise specified.)

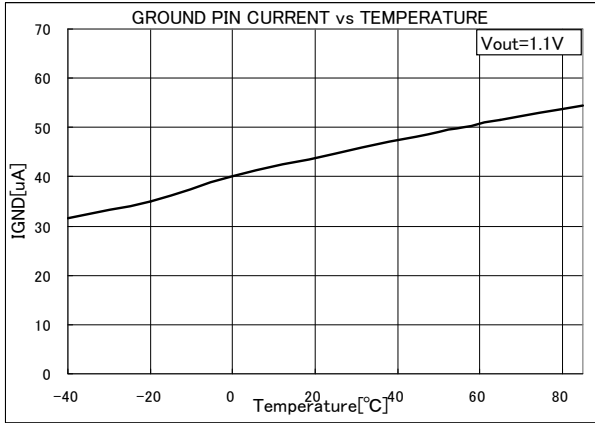

Figure 29.

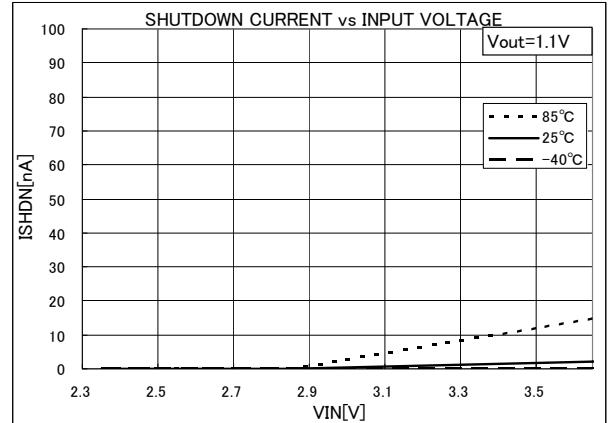

Figure 30.

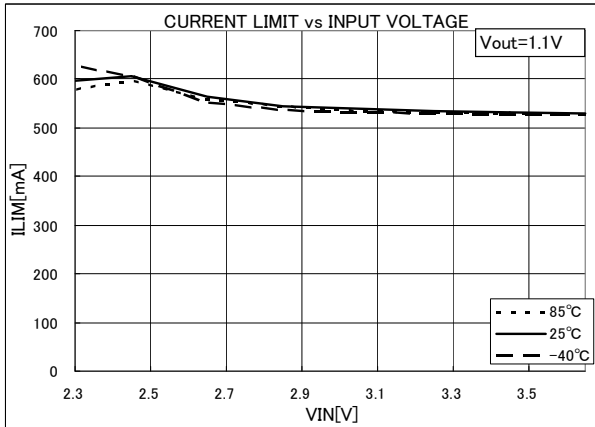

Figure 31.

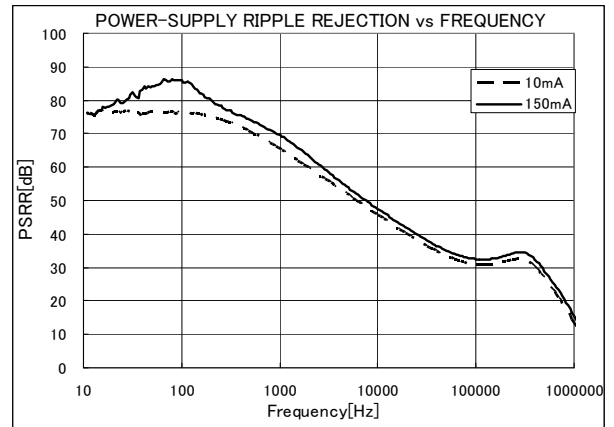

Figure 32.

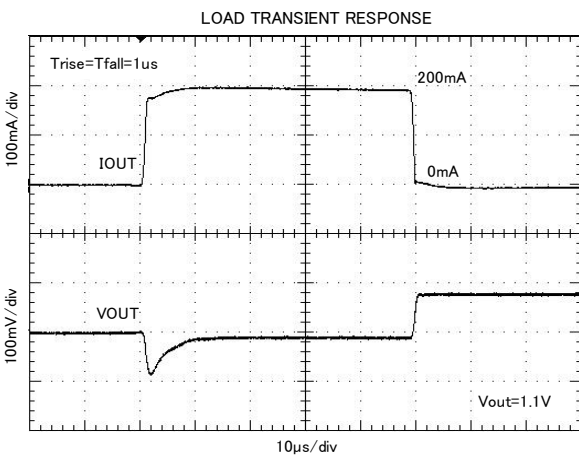

Figure 33.

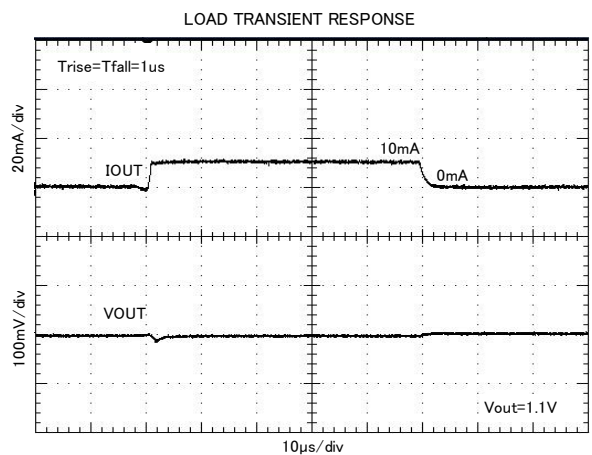

Figure 34.

● Reference data **BU11UC3WG** (Ta=25°C unless otherwise specified.)

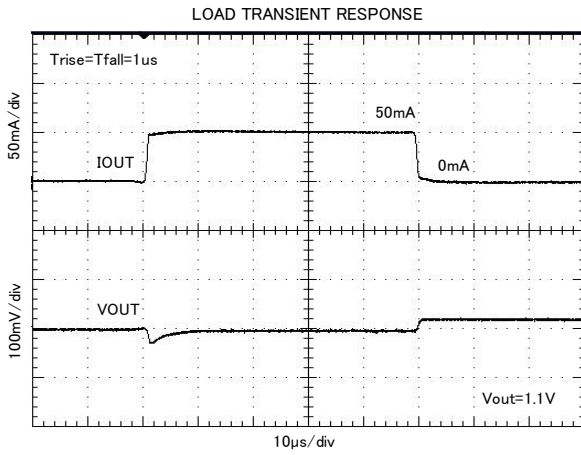

Figure 35.

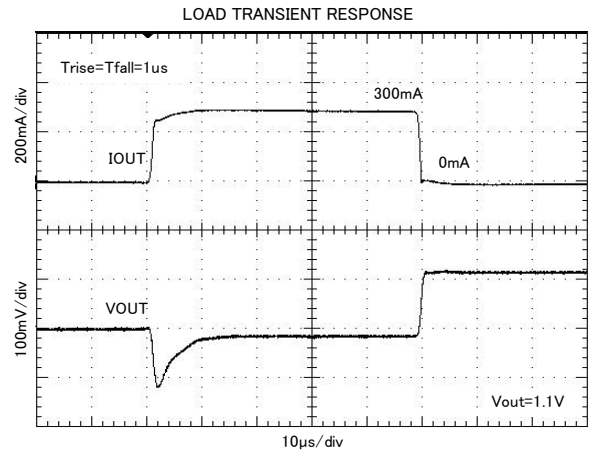

Figure 36.

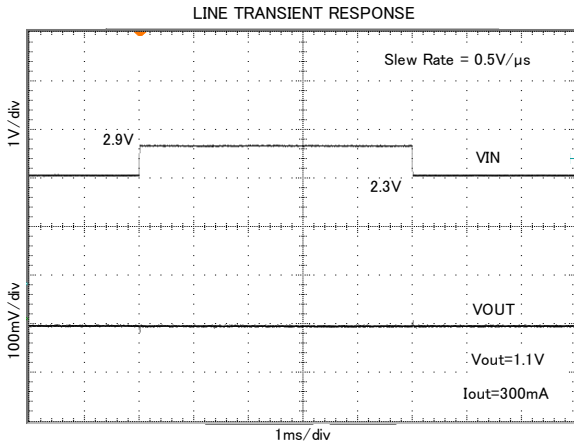

Figure 37.

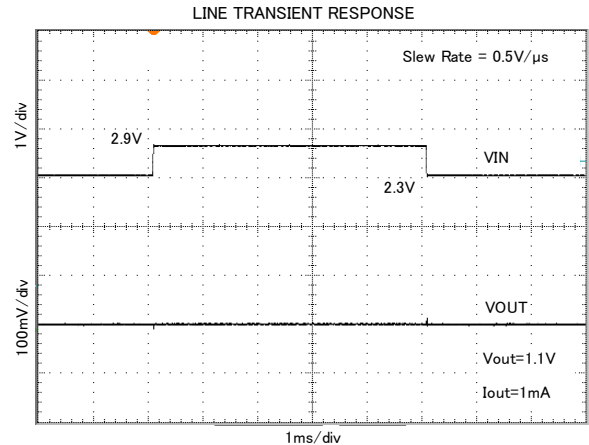

Figure 38.

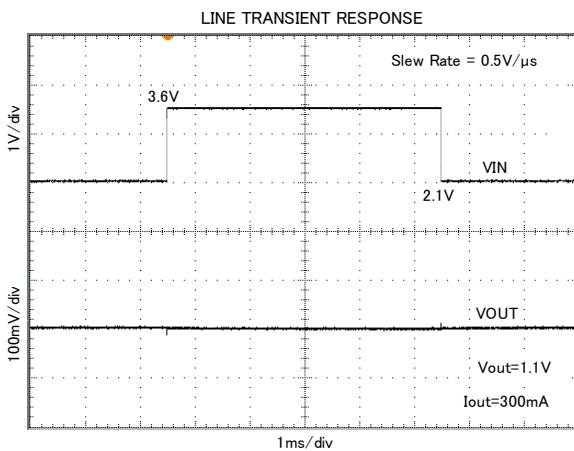

Figure 39.

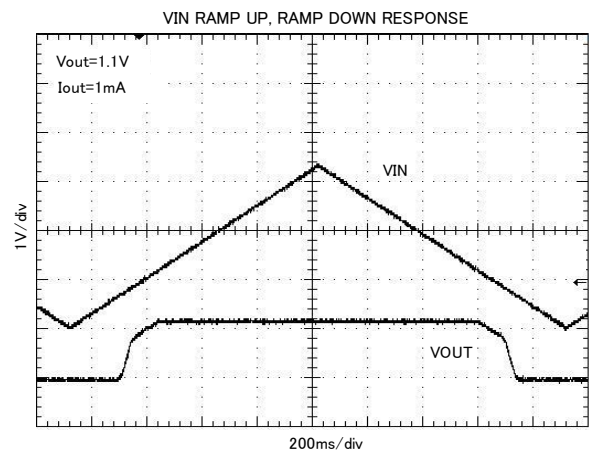

Figure 40.

● Reference data **BU11UC3WG** (Ta=25°C unless otherwise specified)

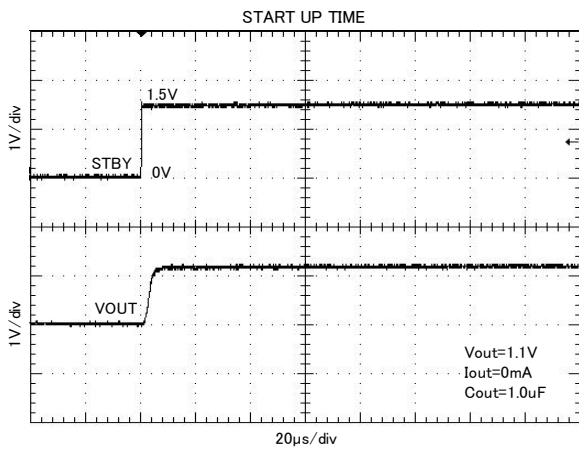

Figure 41.

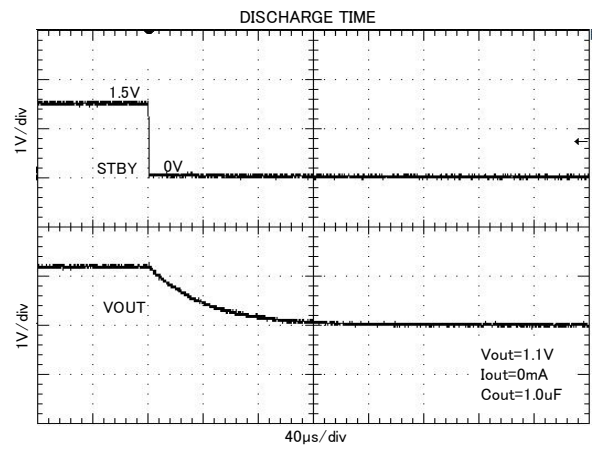

Figure 42.

● Reference data **BU18UC3WG** (Ta=25°C unless otherwise specified.)

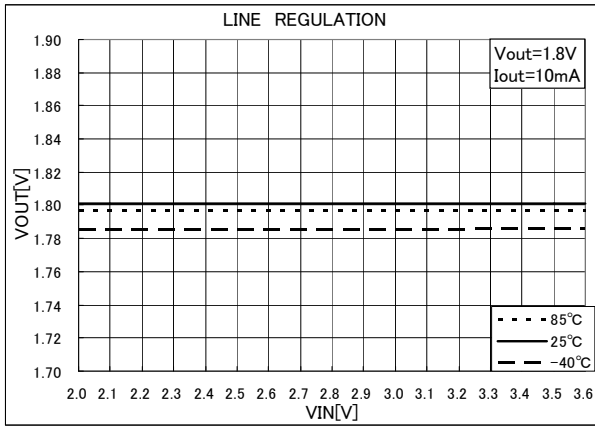

Figure 43.

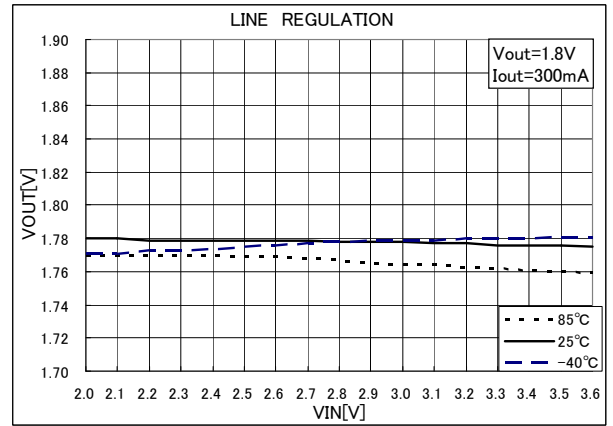

Figure 44.

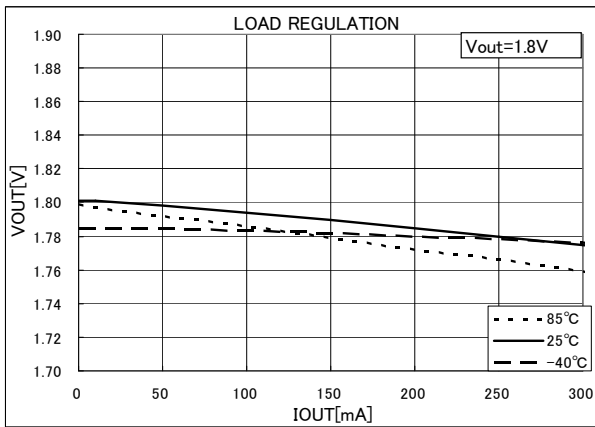

Figure 45.

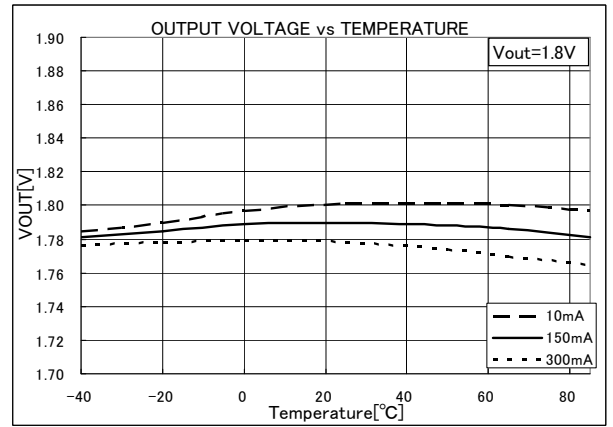

Figure 46.

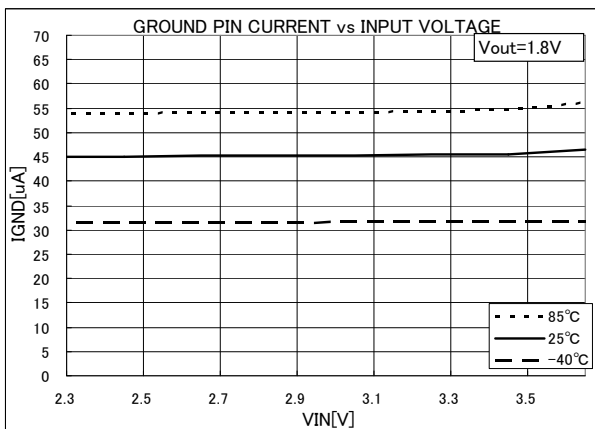

Figure 47.

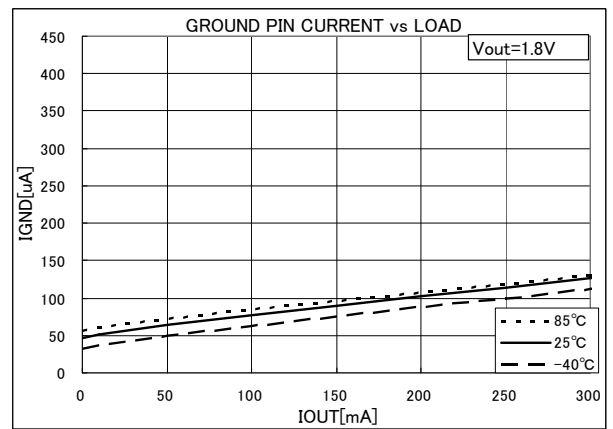

Figure 48.

● Reference data **BU18UC3WG** (Ta=25°C unless otherwise specified.)

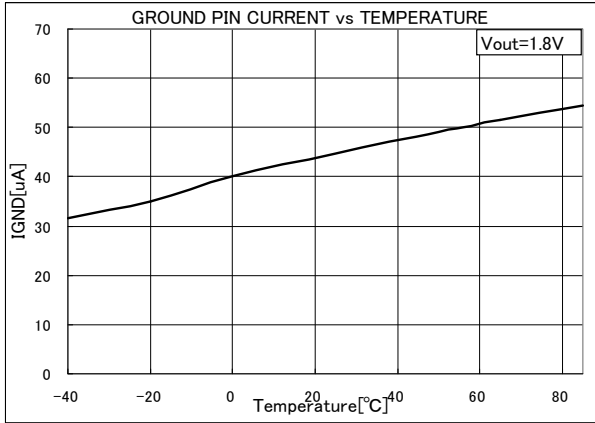

Figure 49.

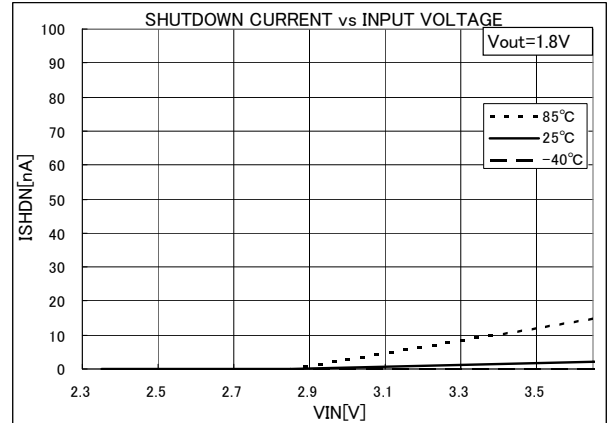

Figure 50.

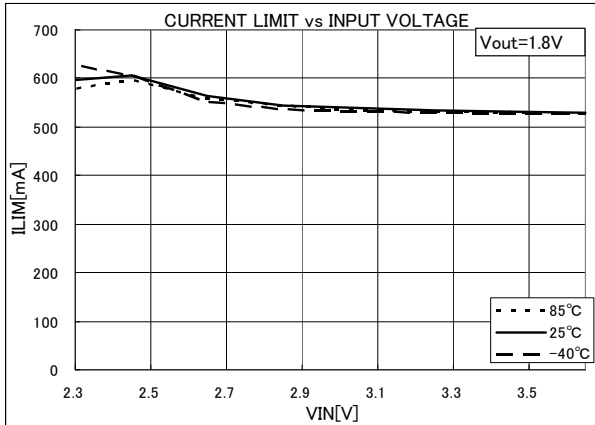

Figure 51.

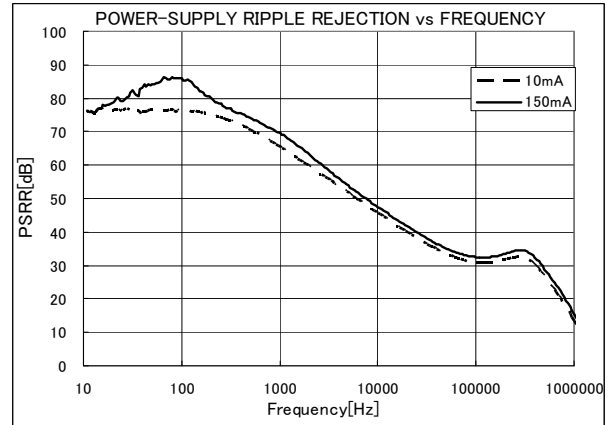

Figure 52.

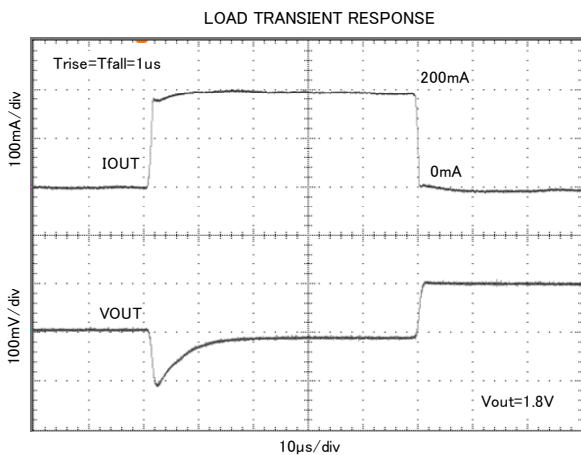

Figure 53.

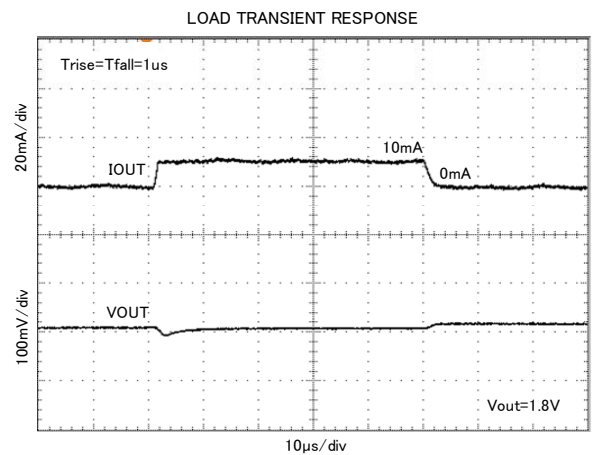

Figure 54.

● Reference data **BU18UC3WG** (Ta=25°C unless otherwise specified.)

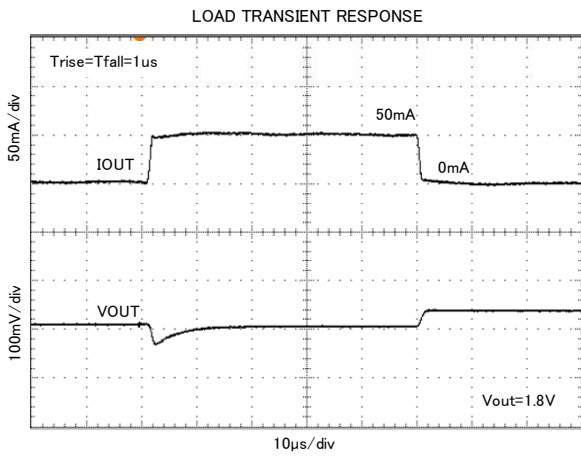

Figure 55.

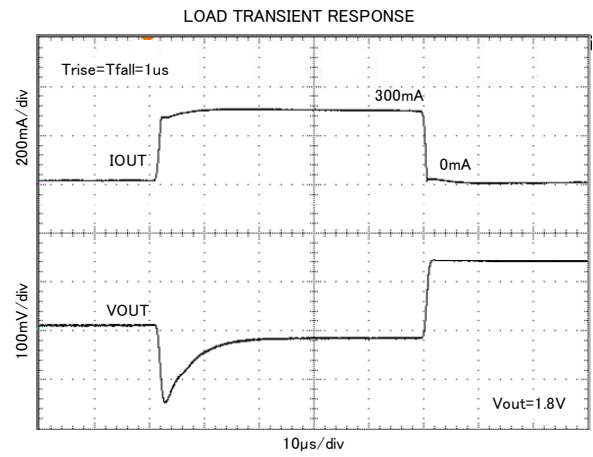

Figure 56.

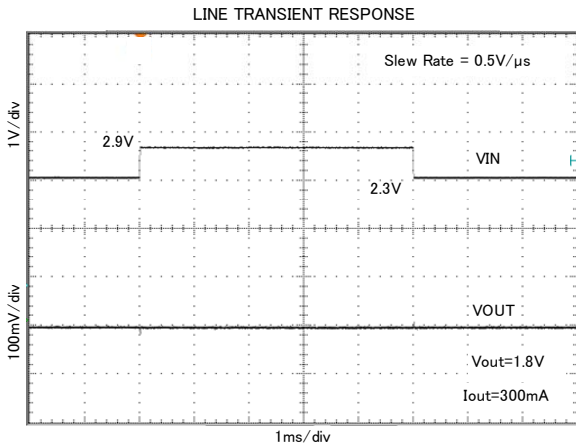

Figure 57.

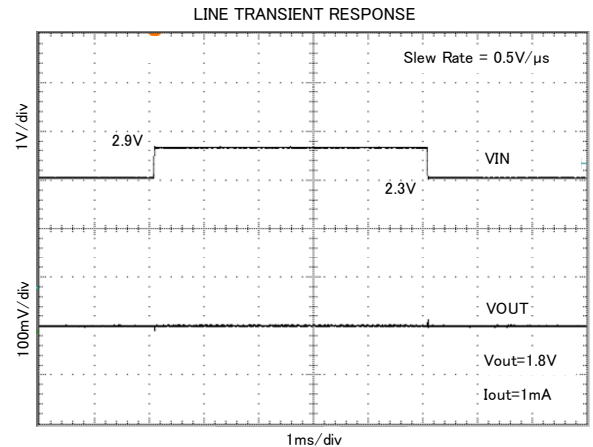

Figure 58.

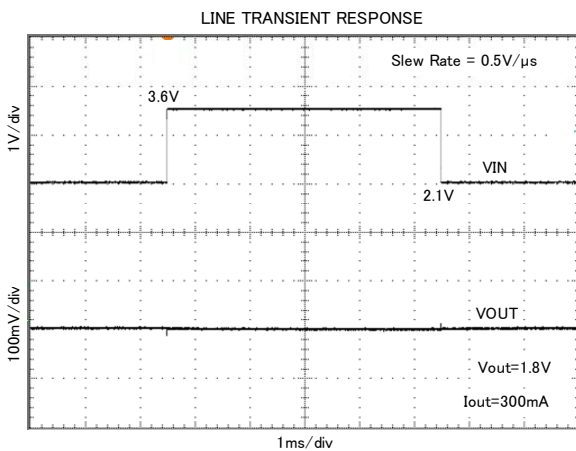

Figure 59.

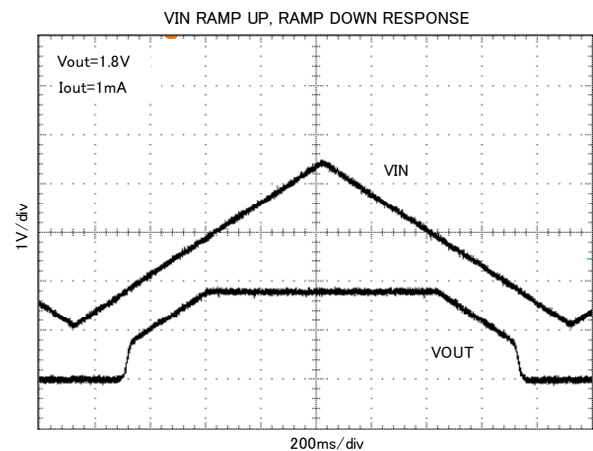

Figure 60.

● Reference data **BU18UC3WG** (Ta=25°C unless otherwise specified.)

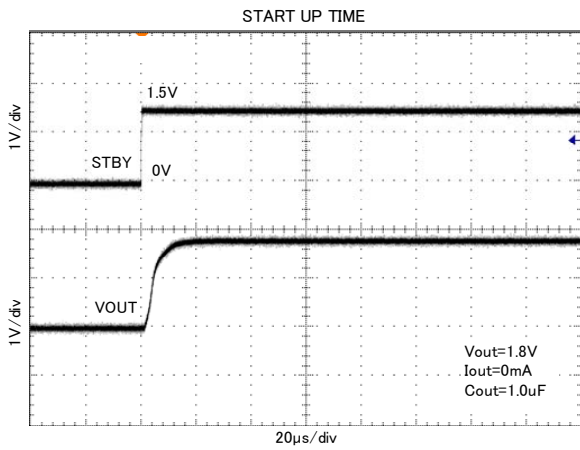

Figure 61.

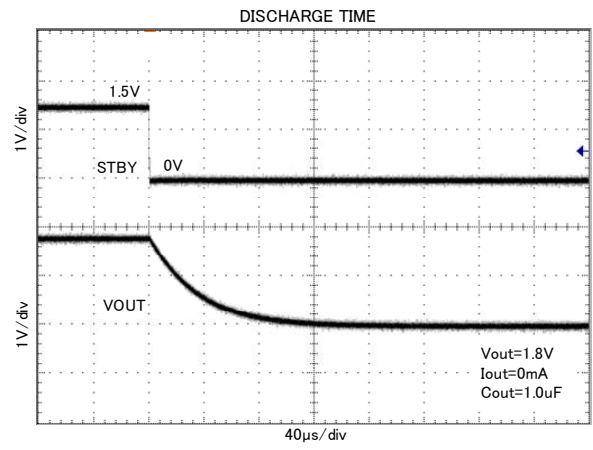

Figure 62.

● Reference data **BU33UC3WG** (Ta=25°C unless otherwise specified.)

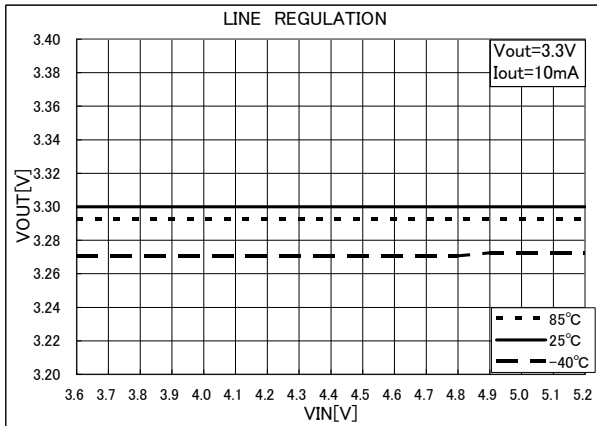

Figure 63.

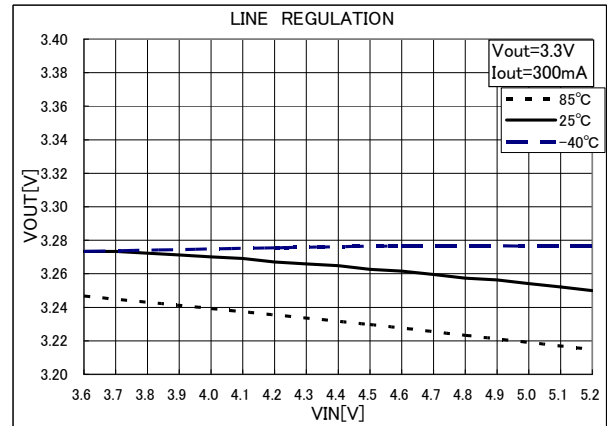

Figure 64.

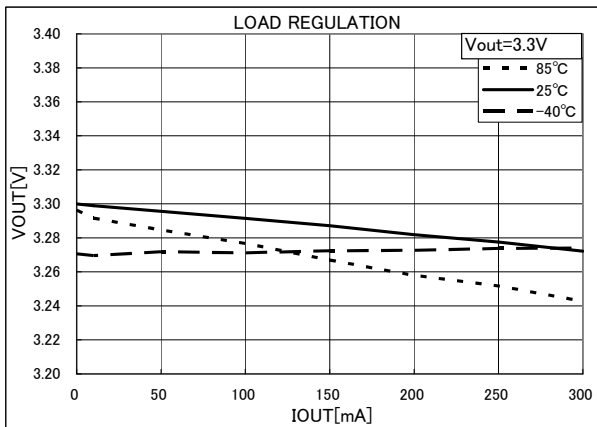

Figure 65.

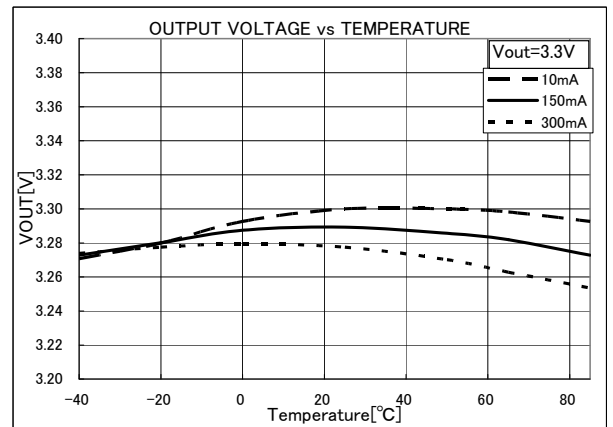

Figure 66.

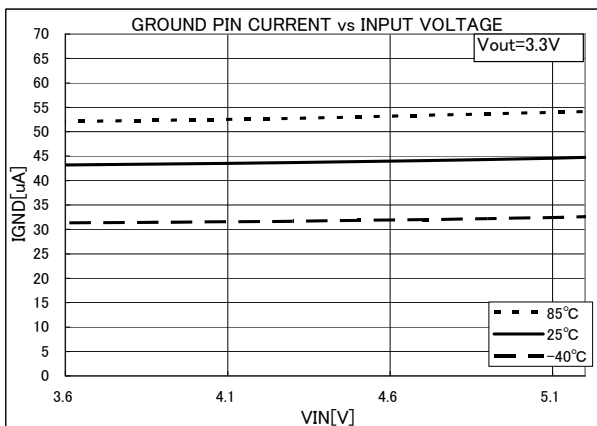

Figure 67.

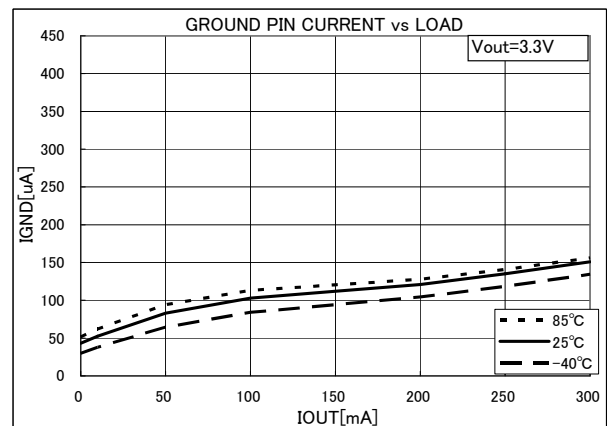

Figure 68.

● Reference data **BU33UC3WG** (Ta=25°C unless otherwise specified.)

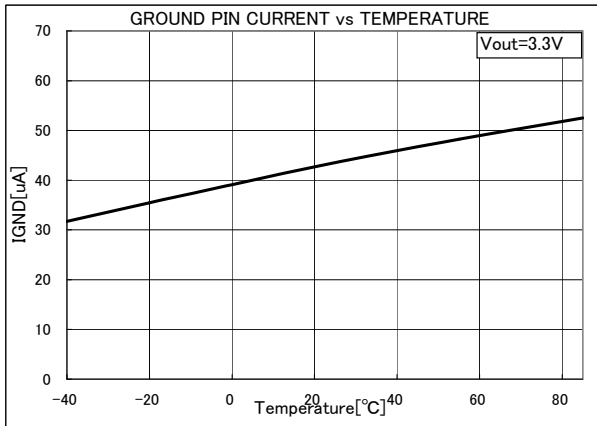

Figure 69.

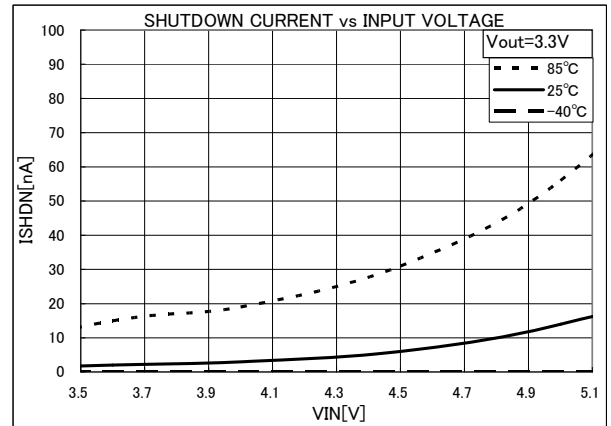

Figure 70.

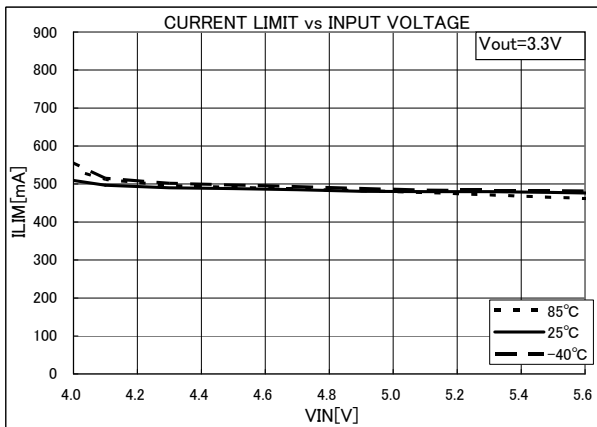

Figure 71.

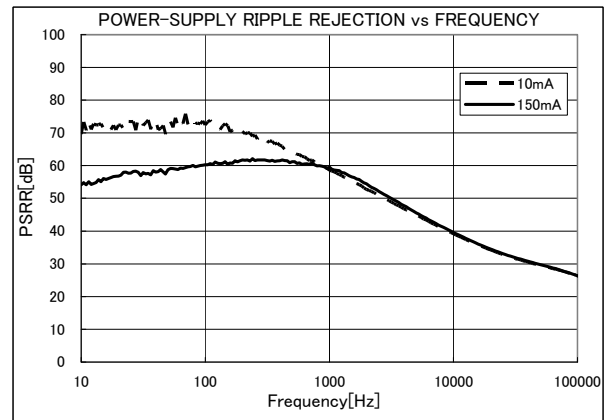

Figure 72.

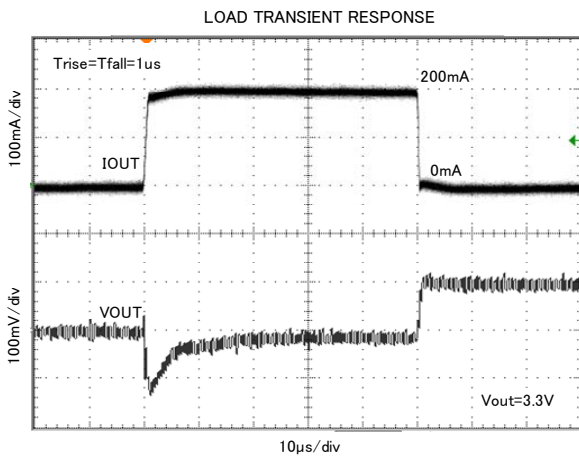

Figure 73.

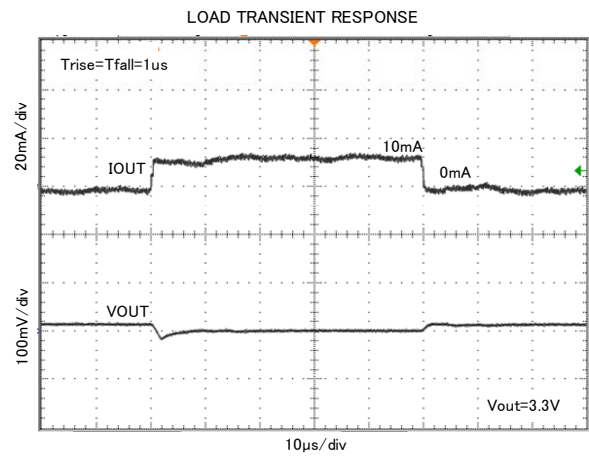

Figure 74.

● Reference data **BU33UC3WG** (Ta=25°C unless otherwise specified.)

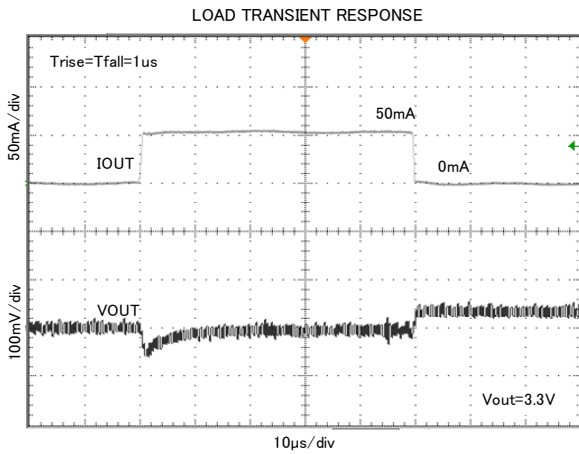

Figure 75.

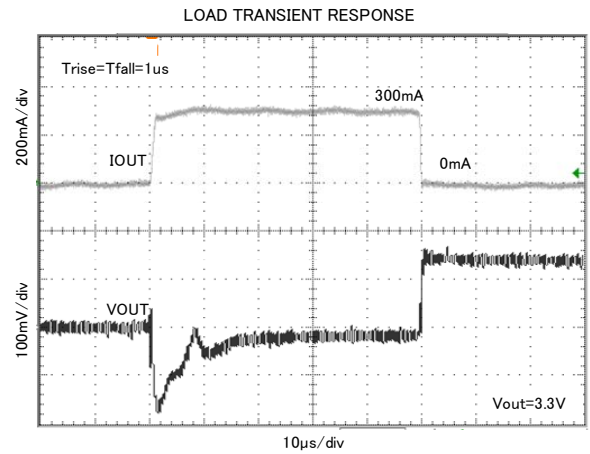

Figure 76.

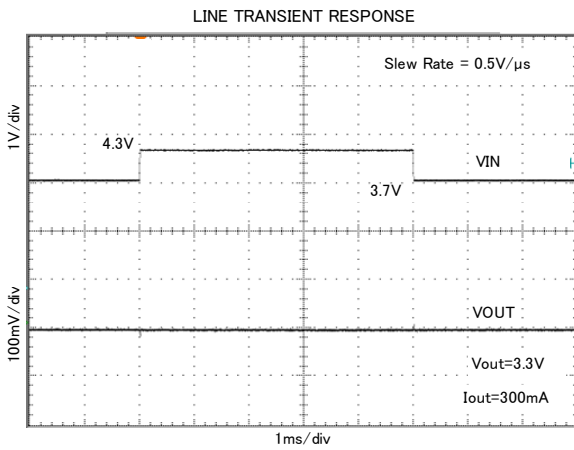

Figure 77.

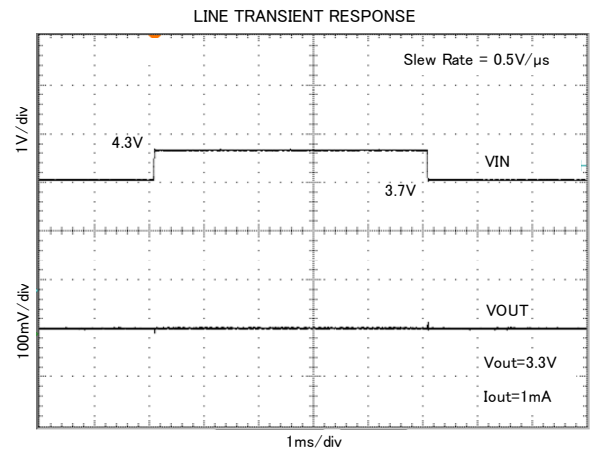

Figure 78.

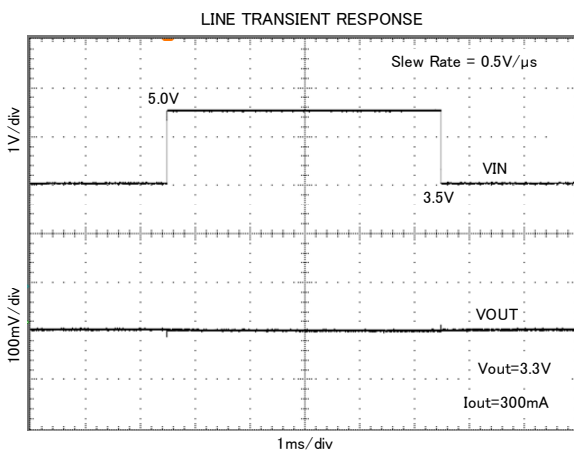

Figure 79.

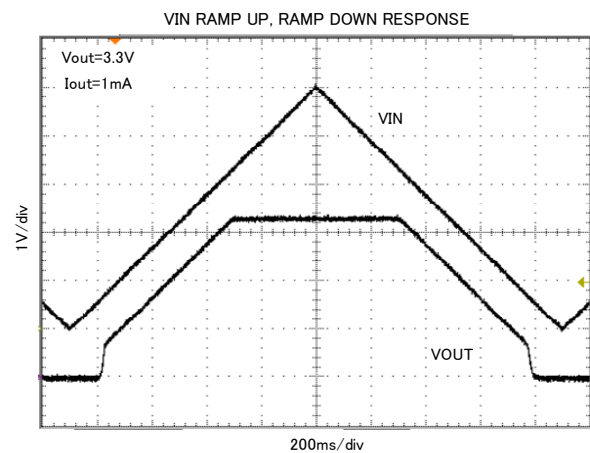

Figure 80.

● Reference data **BU33UC3WG** (Ta=25°C unless otherwise specified.)

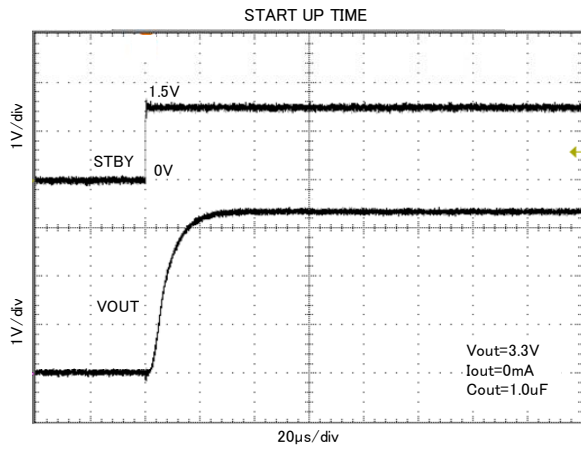

Figure 81.

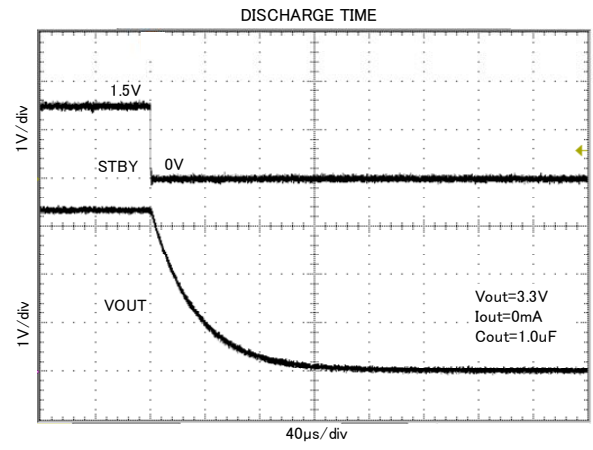

Figure 82.

●About power dissipation (Pd)

As for power dissipation, an approximate estimate of the heat reduction characteristics and internal power consumption of IC are shown, so please use these for reference. Since power dissipation changes substantially depending on the implementation conditions (board size, board thickness, metal wiring rate, number of layers and through holes, etc.), it is recommended to measure Pd on a set board. Exceeding the power dissipation of IC may lead to deterioration of the original IC performance, such as causing operation of the thermal shutdown circuit or reduction in current capability. Therefore, be sure to prepare sufficient margin within power dissipation for usage.

Calculation of the maximum internal power consumption of IC (P_{MAX})

P_{MAX}=(V_{IN}-V_{OUT})×I_{OUT}(MAX.) (V_{IN} : Input voltage V_{OUT} : Output voltage I_{OUT}(MAX) : Maximum output current)

○ Measurement conditions

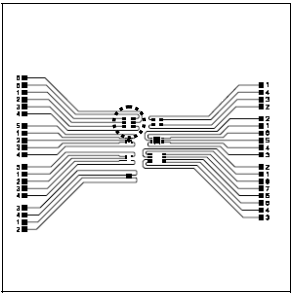
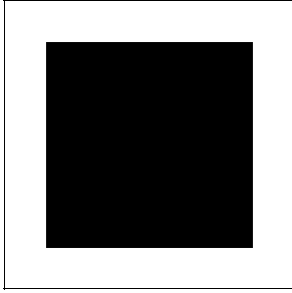
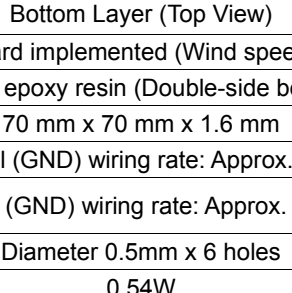
		Standard ROHM Board
Layout of Board for Measurement		
	IC Implementation Position	<p>Top Layer (Top View)</p>  <p>Bottom Layer (Top View)</p> 
Measurement State	With board implemented (Wind speed 0 m/s)	
Board Material	Glass epoxy resin (Double-side board)	
Board Size	70 mm x 70 mm x 1.6 mm	
Wiring Rate	Top layer	Metal (GND) wiring rate: Approx. 0%
	Bottom layer	Metal (GND) wiring rate: Approx. 50%
Through Hole	Diameter 0.5mm x 6 holes	
Power Dissipation	0.54W	
Thermal Resistance	θ _{ja} =185.2°C/W	

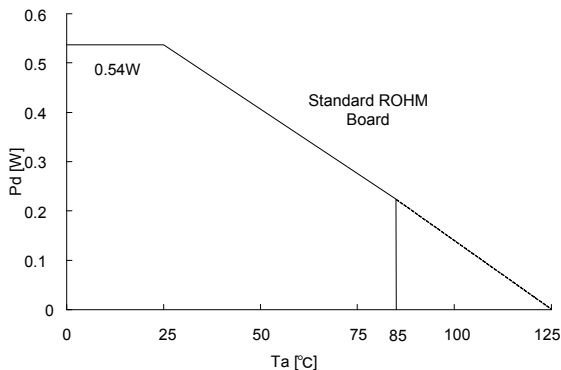

* Please design the margin so that P_{MAX} becomes is than Pd (P_{MAX}<Pd) within the usage temperature range

Figure 83. SSOP5 Power dissipation heat reduction characteristics (Reference)

●Operation Notes

1.) Absolute maximum ratings

Use of the IC in excess of absolute maximum ratings (such as the input voltage or operating temperature range) may result in damage to the IC. Assumptions should not be made regarding the state of the IC (e.g., short mode or open mode) when such damage is suffered. If operational values are expected to exceed the maximum ratings for the device, consider adding protective circuitry (such as fuses) to eliminate the risk of damaging the IC.

2.) GND potential

The potential of the GND pin must be the minimum potential in the system in all operating conditions. Never connect a potential lower than GND to any pin, even if only transiently.

3.) Thermal design

Use a thermal design that allows for a sufficient margin for that package power dissipation rating (Pd) under actual operating conditions.

4.) Inter-pin shorts and mounting errors

Use caution when orienting and positioning the IC for mounting on printed circuit boards. Improper mounting or shorts between pins may result in damage to the IC.

5.) Common impedance

Wiring traces should be as short and wide as possible to minimize common impedance. Bypass capacitors should be used to keep ripple to a minimum.

6.) Voltage of STBY pin

To enable standby mode for all channels, set the STBY pin to 0.3 V or less, and for normal operation, to 1.2 V or more. Setting STBY to a voltage between 0.3 and 1.2 V may cause malfunction and should be avoided. Keep transition time between high and low (or vice versa) to a minimum.

Additionally, if STBY is shorted to VIN, the IC will switch to standby mode and disable the output discharge circuit, causing a temporary voltage to remain on the output pin. If the IC is switched on again while this voltage is present, overshoot may occur on the output. Therefore, in applications where these pins are shorted, the output should always be completely discharged before turning the IC on.

7.) Over-current protection circuit (OCP)

This IC features an integrated over-current and short-protection circuitry on the output to prevent destruction of the IC when the output is shorted. The OCP circuitry is designed only to protect the IC from irregular conditions (such as motor output shorts) and is not designed to be used as an active security device for the application. Therefore, applications should not be designed under the assumption that this circuitry will engage.

8.) Thermal shutdown circuit (TSD)

This IC also features a thermal shutdown circuit that is designed to turn the output off when the junction temperature of the IC exceeds about 150°C. This feature is intended to protect the IC only in the event of thermal overload and is not designed to guarantee operation or act as an active security device for the application. Therefore, applications should not be designed under the assumption that this circuitry will engage.

9.) Input/output capacitor

Capacitors must be connected between the input/output pins and GND for stable operation, and should be physically mounted as close to the IC pins as possible. The input capacitor helps to counteract increases in power supply impedance, and increases stability in applications with long or winding power supply traces. The output capacitance value is directly related to the overall stability and transient response of the regulator, and should be set to the largest possible value for the application to increase these characteristics. During design, keep in mind that in general, ceramic capacitors have a wide range of tolerances, temperature coefficients and DC bias characteristics, and that their capacitance values tend to decrease over time. Confirm these details before choosing appropriate capacitors for your application. (Please refer the technical note, regarding ceramic capacitor of recommendation)

10.) About the equivalent series resistance (ESR) of a ceramic capacitor

Cout=1.0uF Cin=1.0uF Temp=25°C

Capacitors generally have ESR (equivalent series resistance) and it operates stably in the ESR-IOUT area shown on the right. Since ceramic capacitors, tantalum capacitors, electrolytic capacitors, etc. generally have different ESR, please check the ESR of the capacitor to be used and use it within the stability area range shown in the right graph for evaluation of the actual application.

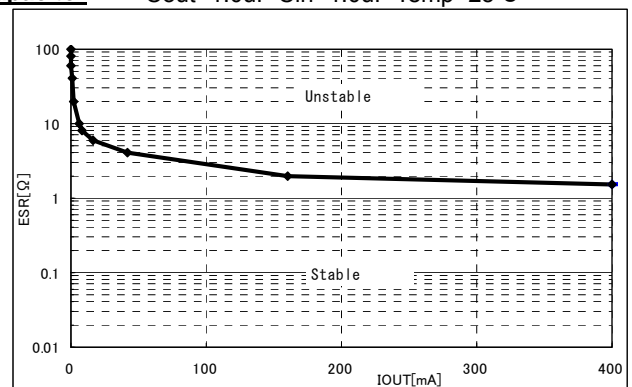

Figure 84. Stable region (example)

●Revision History

Date	Revision	Changes
27.Jun.2013	001	New Release
02.Jul.2013	002	Absolute Maximum Ratings of Power Supply Voltage is changed. Adding reference data.
16.Apr.2014	003	Adding reference data.
23.Jan.2015	004	Line up is changed.
29.Jan.2015	005	Reference data is changed.

Notice

Precaution on using ROHM Products

- Our Products are designed and manufactured for application in ordinary electronic equipments (such as AV equipment, OA equipment, telecommunication equipment, home electronic appliances, amusement equipment, etc.). If you intend to use our Products in devices requiring extremely high reliability (such as medical equipment ^(Note 1), transport equipment, traffic equipment, aircraft/spacecraft, nuclear power controllers, fuel controllers, car equipment including car accessories, safety devices, etc.) and whose malfunction or failure may cause loss of human life, bodily injury or serious damage to property ("Specific Applications"), please consult with the ROHM sales representative in advance. Unless otherwise agreed in writing by ROHM in advance, ROHM shall not be in any way responsible or liable for any damages, expenses or losses incurred by you or third parties arising from the use of any ROHM's Products for Specific Applications.

(Note1) Medical Equipment Classification of the Specific Applications

JAPAN	USA	EU	CHINA
CLASS III	CLASS III	CLASS II b	CLASS III
CLASS IV		CLASS III	

- ROHM designs and manufactures its Products subject to strict quality control system. However, semiconductor products can fail or malfunction at a certain rate. Please be sure to implement, at your own responsibilities, adequate safety measures including but not limited to fail-safe design against the physical injury, damage to any property, which a failure or malfunction of our Products may cause. The following are examples of safety measures:
 - Installation of protection circuits or other protective devices to improve system safety
 - Installation of redundant circuits to reduce the impact of single or multiple circuit failure
- Our Products are designed and manufactured for use under standard conditions and not under any special or extraordinary environments or conditions, as exemplified below. Accordingly, ROHM shall not be in any way responsible or liable for any damages, expenses or losses arising from the use of any ROHM's Products under any special or extraordinary environments or conditions. If you intend to use our Products under any special or extraordinary environments or conditions (as exemplified below), your independent verification and confirmation of product performance, reliability, etc. prior to use, must be necessary:
 - Use of our Products in any types of liquid, including water, oils, chemicals, and organic solvents
 - Use of our Products outdoors or in places where the Products are exposed to direct sunlight or dust
 - Use of our Products in places where the Products are exposed to sea wind or corrosive gases, including Cl₂, H₂S, NH₃, SO₂, and NO₂
 - Use of our Products in places where the Products are exposed to static electricity or electromagnetic waves
 - Use of our Products in proximity to heat-producing components, plastic cords, or other flammable items
 - Sealing or coating our Products with resin or other coating materials
 - Use of our Products without cleaning residue of flux (even if you use no-clean type fluxes, cleaning residue of flux is recommended); or Washing our Products by using water or water-soluble cleaning agents for cleaning residue after soldering
 - Use of the Products in places subject to dew condensation
- The Products are not subject to radiation-proof design.
- Please verify and confirm characteristics of the final or mounted products in using the Products.
- In particular, if a transient load (a large amount of load applied in a short period of time, such as pulse. is applied, confirmation of performance characteristics after on-board mounting is strongly recommended. Avoid applying power exceeding normal rated power; exceeding the power rating under steady-state loading condition may negatively affect product performance and reliability.
- De-rate Power Dissipation (Pd) depending on Ambient temperature (Ta). When used in sealed area, confirm the actual ambient temperature.
- Confirm that operation temperature is within the specified range described in the product specification.
- ROHM shall not be in any way responsible or liable for failure induced under deviant condition from what is defined in this document.

Precaution for Mounting / Circuit board design

- When a highly active halogenous (chlorine, bromine, etc.) flux is used, the residue of flux may negatively affect product performance and reliability.
- In principle, the reflow soldering method must be used on a surface-mount products, the flow soldering method must be used on a through hole mount products. If the flow soldering method is preferred on a surface-mount products, please consult with the ROHM representative in advance.

For details, please refer to ROHM Mounting specification

Precautions Regarding Application Examples and External Circuits

1. If change is made to the constant of an external circuit, please allow a sufficient margin considering variations of the characteristics of the Products and external components, including transient characteristics, as well as static characteristics.
2. You agree that application notes, reference designs, and associated data and information contained in this document are presented only as guidance for Products use. Therefore, in case you use such information, you are solely responsible for it and you must exercise your own independent verification and judgment in the use of such information contained in this document. ROHM shall not be in any way responsible or liable for any damages, expenses or losses incurred by you or third parties arising from the use of such information.

Precaution for Electrostatic

This Product is electrostatic sensitive product, which may be damaged due to electrostatic discharge. Please take proper caution in your manufacturing process and storage so that voltage exceeding the Products maximum rating will not be applied to Products. Please take special care under dry condition (e.g. Grounding of human body / equipment / solder iron, isolation from charged objects, setting of Ionizer, friction prevention and temperature / humidity control).

Precaution for Storage / Transportation

1. Product performance and soldered connections may deteriorate if the Products are stored in the places where:
 - [a] the Products are exposed to sea winds or corrosive gases, including Cl₂, H₂S, NH₃, SO₂, and NO₂
 - [b] the temperature or humidity exceeds those recommended by ROHM
 - [c] the Products are exposed to direct sunshine or condensation
 - [d] the Products are exposed to high Electrostatic
2. Even under ROHM recommended storage condition, solderability of products out of recommended storage time period may be degraded. It is strongly recommended to confirm solderability before using Products of which storage time is exceeding the recommended storage time period.
3. Store / transport cartons in the correct direction, which is indicated on a carton with a symbol. Otherwise bent leads may occur due to excessive stress applied when dropping of a carton.
4. Use Products within the specified time after opening a humidity barrier bag. Baking is required before using Products of which storage time is exceeding the recommended storage time period.

Precaution for Product Label

QR code printed on ROHM Products label is for ROHM's internal use only.

Precaution for Disposition

When disposing Products please dispose them properly using an authorized industry waste company.

Precaution for Foreign Exchange and Foreign Trade act

Since our Products might fall under controlled goods prescribed by the applicable foreign exchange and foreign trade act, please consult with ROHM representative in case of export.

Precaution Regarding Intellectual Property Rights

1. All information and data including but not limited to application example contained in this document is for reference only. ROHM does not warrant that foregoing information or data will not infringe any intellectual property rights or any other rights of any third party regarding such information or data. ROHM shall not be in any way responsible or liable for infringement of any intellectual property rights or other damages arising from use of such information or data.:
2. No license, expressly or implied, is granted hereby under any intellectual property rights or other rights of ROHM or any third parties with respect to the information contained in this document.

Other Precaution

1. This document may not be reprinted or reproduced, in whole or in part, without prior written consent of ROHM.
2. The Products may not be disassembled, converted, modified, reproduced or otherwise changed without prior written consent of ROHM.
3. In no event shall you use in any way whatsoever the Products and the related technical information contained in the Products or this document for any military purposes, including but not limited to, the development of mass-destruction weapons.
4. The proper names of companies or products described in this document are trademarks or registered trademarks of ROHM, its affiliated companies or third parties.

General Precaution

1. Before you use our Products, you are requested to carefully read this document and fully understand its contents. ROHM shall not be in any way responsible or liable for failure, malfunction or accident arising from the use of any ROHM's Products against warning, caution or note contained in this document.
2. All information contained in this document is current as of the issuing date and subject to change without any prior notice. Before purchasing or using ROHM's Products, please confirm the latest information with a ROHM sales representative.
3. The information contained in this document is provided on an "as is" basis and ROHM does not warrant that all information contained in this document is accurate and/or error-free. ROHM shall not be in any way responsible or liable for any damages, expenses or losses incurred by you or third parties resulting from inaccuracy or errors of or concerning such information.