

## IGBT With Antiparallel Diode

### *Preliminary data sheet*

- Low forward voltage drop
- High switching speed
- Low tail current
- Latch-up free
- Including fast free-wheel diode

Former Development ID: BUP 3JKD

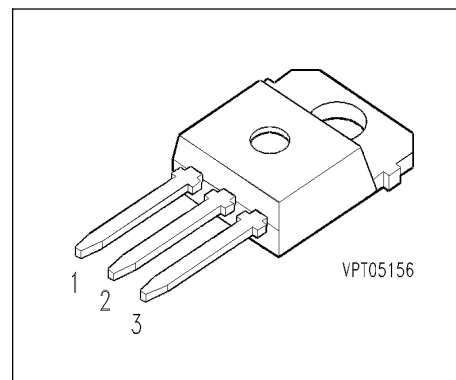

Pin 1	Pin 2	Pin 3
G	C	E

Type	$V_{CE}$	$I_C$	Package	Ordering Code
BUP 311D	1200V	A	TO-218 AB	C67078-A4102

### Maximum Ratings

Parameter	Symbol	Values	Unit
Collector-emitter voltage	$V_{CE}$	1200	V
Collector-gate voltage	$V_{CGR}$	1200	
$R_{GE} = 20 \text{ k}\Omega$			
Gate-emitter voltage	$V_{GE}$	$\pm 20$	
DC collector current	$I_C$	20	A
$T_C = 25 \text{ }^\circ\text{C}$			
$T_C = 100 \text{ }^\circ\text{C}$		12	
Pulsed collector current, $t_p = 1 \text{ ms}$	$I_{Cpuls}$	40	
$T_C = 25 \text{ }^\circ\text{C}$			
Diode forward current	$I_F$	tbd	
$T_C = 100 \text{ }^\circ\text{C}$			
Pulsed diode current, $t_p = 1 \text{ ms}$	$I_{Fpuls}$	tbd	
$T_C = 25 \text{ }^\circ\text{C}$			
Power dissipation	$P_{tot}$	125	W
$T_C = 25 \text{ }^\circ\text{C}$			
Chip or operating temperature	$T_j$	-55 ... + 150	$^\circ\text{C}$
Storage temperature	$T_{stg}$	-55 ... + 150	

## Maximum Ratings

Parameter	Symbol	Values	Unit
Chip or operating temperature	$T_j$	-55 ... + 150	°C
Storage temperature	$T_{stg}$	-55 ... + 150	
IEC climatic category, DIN IEC 68-1	-	55 / 150 / 56	-

## Thermal Resistance

Thermal resistance, junction - case	$R_{thJC}$	$\leq 1$	K/W
Diode thermal resistance, chip case	$R_{thJCD}$	$\leq 2.5$	

## Electrical Characteristics, at $T_j = 25\text{ °C}$ , unless otherwise specified

Parameter	Symbol	Values			Unit
		min.	typ.	max.	

### Static Characteristics

Gate threshold voltage $V_{GE} = V_{CE}, I_C = 0.3\text{ mA}, T_j = 25\text{ °C}$	$V_{GE(th)}$	4.5	5.5	6.5	V
Collector-emitter saturation voltage $V_{GE} = 15\text{ V}, I_C = 8\text{ A}, T_j = 25\text{ °C}$	$V_{CE(sat)}$	-	2.5	3	
$V_{GE} = 15\text{ V}, I_C = 8\text{ A}, T_j = 125\text{ °C}$		-	3.1	3.7	
$V_{GE} = 15\text{ V}, I_C = 16\text{ A}, T_j = 25\text{ °C}$		-	3.4	-	
$V_{GE} = 15\text{ V}, I_C = 16\text{ A}, T_j = 125\text{ °C}$		-	4.3	-	
Zero gate voltage collector current $V_{CE} = 1200\text{ V}, V_{GE} = 0\text{ V}, T_j = 25\text{ °C}$	$I_{CES}$	-	-	0.4	mA
Gate-emitter leakage current $V_{GE} = 25\text{ V}, V_{CE} = 0\text{ V}$	$I_{GES}$	-	-	120	nA

## AC Characteristics

Transconductance $V_{CE} = 20 \text{ V}, I_C = 8 \text{ A}$	$g_{fs}$	4	-	-	S
Input capacitance $V_{CE} = 25 \text{ V}, V_{GE} = 0 \text{ V}, f = 1 \text{ MHz}$	$C_{iss}$	-	600	tbd	pF
Output capacitance $V_{CE} = 25 \text{ V}, V_{GE} = 0 \text{ V}, f = 1 \text{ MHz}$	$C_{oss}$	-	60	tbd	
Reverse transfer capacitance $V_{CE} = 25 \text{ V}, V_{GE} = 0 \text{ V}, f = 1 \text{ MHz}$	$C_{rss}$	-	38	tbd	

## Electrical Characteristics, at $T_j = 25 \text{ }^\circ\text{C}$ , unless otherwise specified

Parameter	Symbol	Values			Unit
		min.	typ.	max.	

## Switching Characteristics, Inductive Load at $T_j = 125 \text{ }^\circ\text{C}$

Turn-on delay time $V_{CC} = 600 \text{ V}, V_{GE} = 15 \text{ V}, I_C = 8 \text{ A}$ $R_{Gon} = 150 \text{ } \Omega$	$t_{d(on)}$	-	55	tbd	ns
Rise time $V_{CC} = 600 \text{ V}, V_{GE} = 15 \text{ V}, I_C = 8 \text{ A}$ $R_{Gon} = 150 \text{ } \Omega$	$t_r$	-	50	tbd	
Turn-off delay time $V_{CC} = 600 \text{ V}, V_{GE} = -15 \text{ V}, I_C = 8 \text{ A}$ $R_{Goff} = 150 \text{ } \Omega$	$t_{d(off)}$	-	380	tbd	
Fall time $V_{CC} = 600 \text{ V}, V_{GE} = -15 \text{ V}, I_C = 8 \text{ A}$ $R_{Goff} = 150 \text{ } \Omega$	$t_f$	-	80	tbd	

## Free-Wheel Diode

Diode forward voltage $I_F = 8 \text{ A}$ , $V_{GE} = 0 \text{ V}$ , $T_j = 25 \text{ °C}$ $I_F = 8 \text{ A}$ , $V_{GE} = 0 \text{ V}$ , $T_j = 125 \text{ °C}$	$V_F$	- -	tbd tbd	tbd -	V
Reverse recovery time $I_F = 8 \text{ A}$ , $V_R = -600 \text{ V}$ , $V_{GE} = 0 \text{ V}$ $di_F/dt = -400 \text{ A}/\mu\text{s}$ , $T_j = 25 \text{ °C}$	$t_{rr}$	-	tbd	tbd	ns
Reverse recovery charge $I_F = 15 \text{ A}$ , $V_R = -600 \text{ V}$ , $V_{GE} = 0 \text{ V}$ $di_F/dt = -400 \text{ A}/\mu\text{s}$ $T_j = 25 \text{ °C}$ $T_j = 125 \text{ °C}$	$Q_{rr}$	- -	tbd tbd	tbd tbd	$\mu\text{C}$

### Power dissipation

$$P_{\text{tot}} = f(T_C)$$

parameter:  $T_j \leq 150\text{ }^\circ\text{C}$

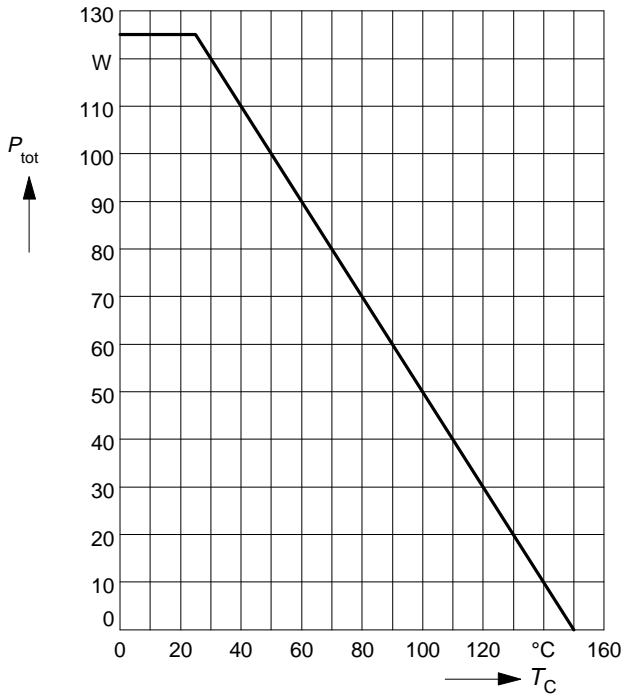

### Collector current

$$I_C = f(T_C)$$

parameter:  $V_{\text{GE}} \geq 15\text{ V}$ ,  $T_j \leq 150\text{ }^\circ\text{C}$

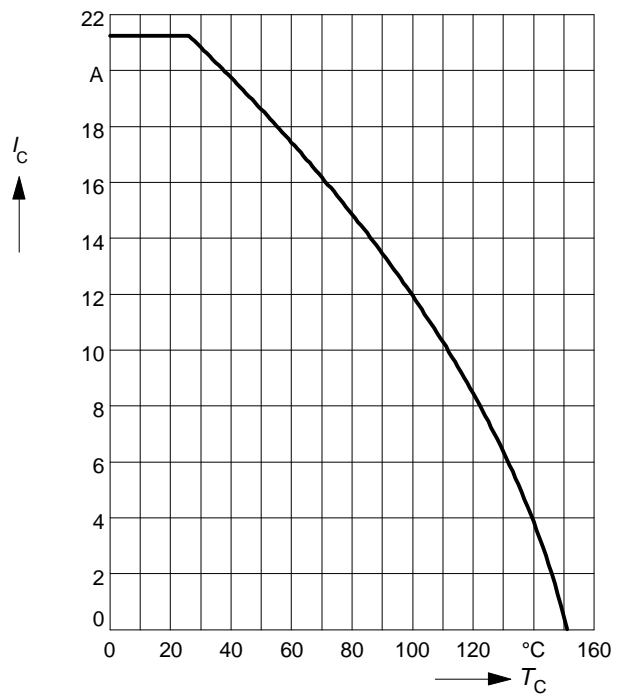

### Safe operating area

$$I_C = f(V_{\text{CE}})$$

parameter:  $D = 0$ ,  $T_C = 25\text{ }^\circ\text{C}$ ,  $T_j \leq 150\text{ }^\circ\text{C}$

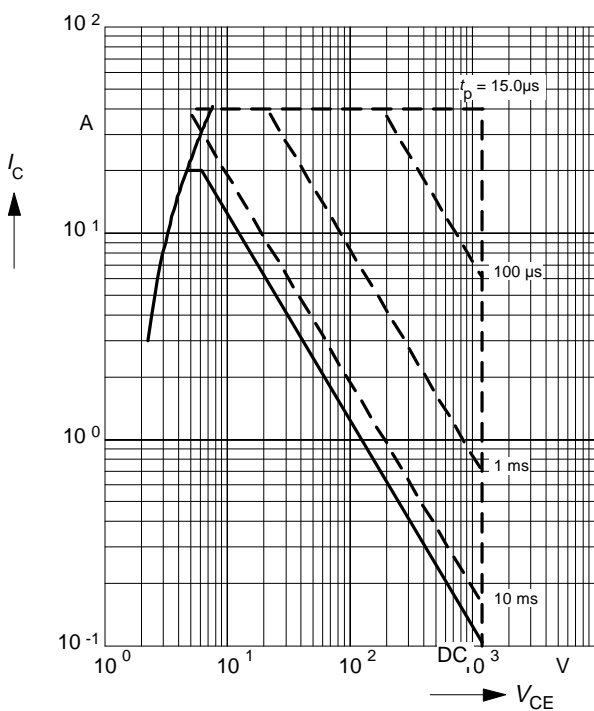

### Transient thermal impedance IGBT

$$Z_{\text{thJC}} = f(t_p)$$

parameter:  $D = t_p / T$

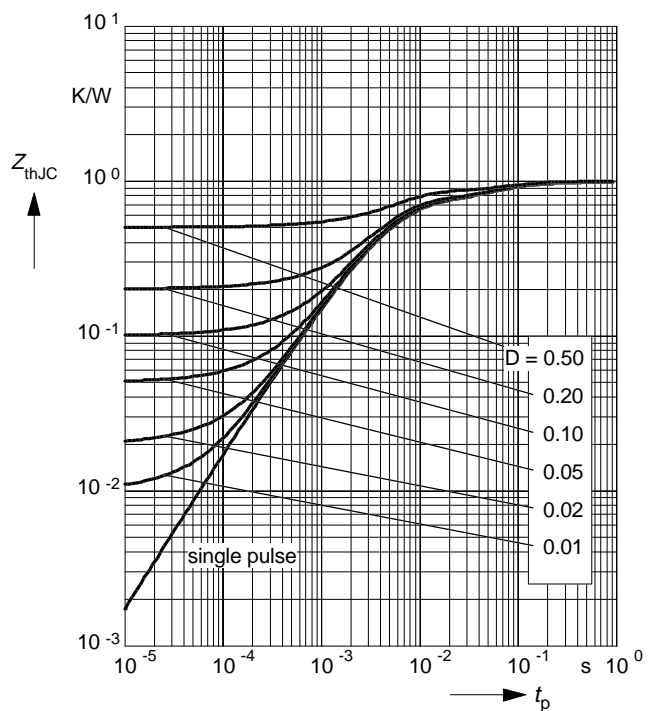

### Typ. output characteristics

$$I_C = f(V_{CE})$$

parameter:  $t_p = 80 \mu s, T_j = 25 \text{ }^\circ\text{C}$

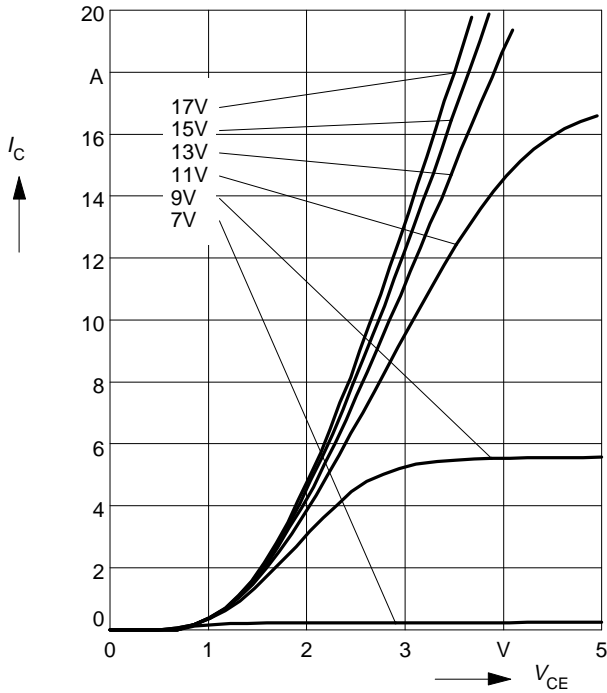

### Typ. output characteristics

$$I_C = f(V_{CE})$$

parameter:  $t_p = 80 \mu s, T_j = 125 \text{ }^\circ\text{C}$

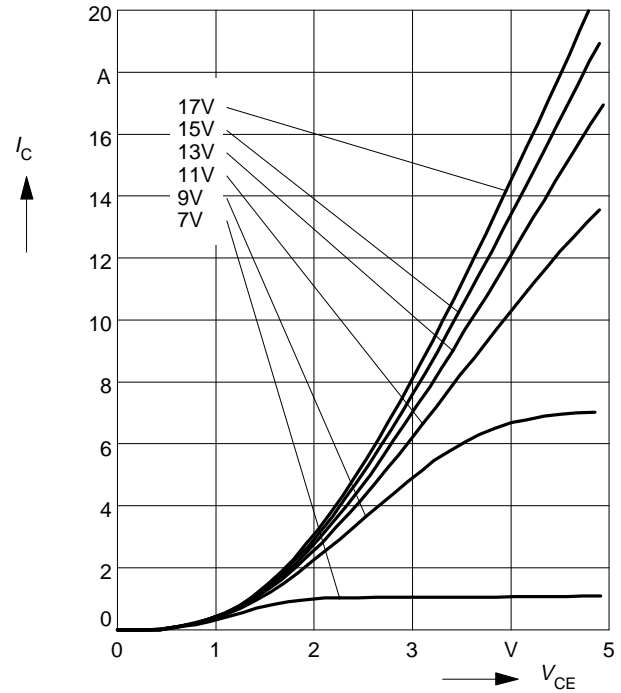

### Typ. transfer characteristics

$$I_C = f(V_{GE})$$

parameter:  $t_p = 80 \mu s, V_{CE} = 20 \text{ V}$

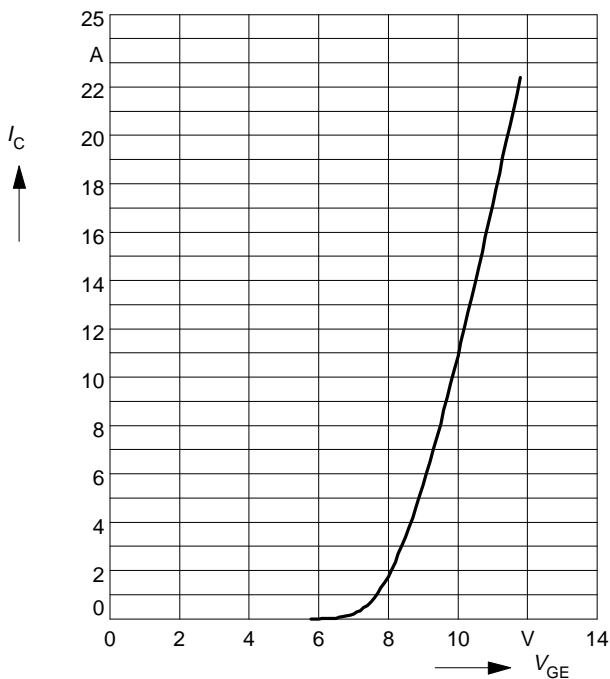

### Typ. switching time

$t = f(I_C)$ , inductive load,  $T_j = 125^\circ\text{C}$   
 par.:  $V_{CE}=600\text{V}$ ,  $V_{GE} = \pm 15\text{V}$ ,  $R_G = 153\Omega$

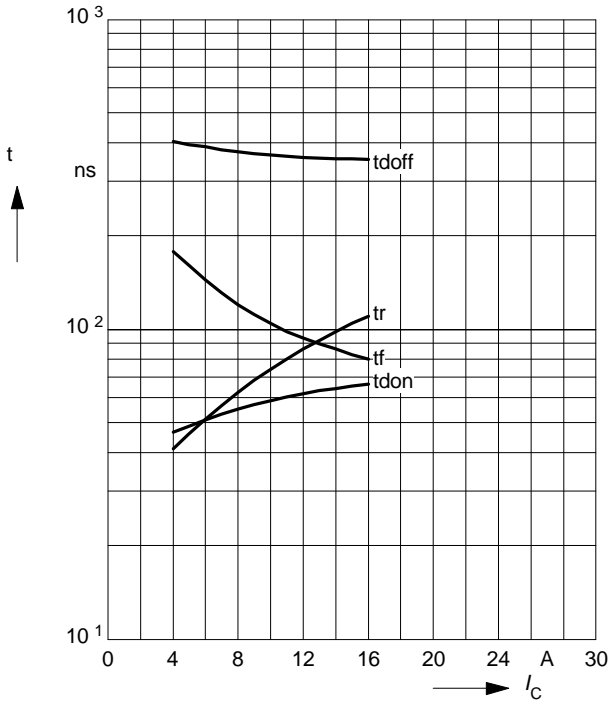

### Typ. switching time

$t = f(R_G)$ , inductive load,  $T_j = 125^\circ\text{C}$   
 par.:  $V_{CE}=600\text{V}$ ,  $V_{GE} = \pm 15\text{V}$ ,  $I_C = 8\text{ A}$

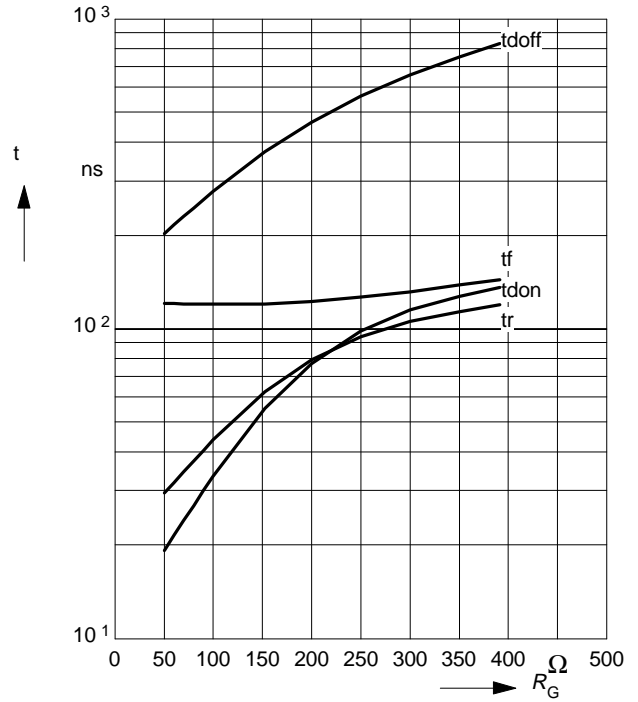

### Typ. switching losses

$E = f(I_C)$ , inductive load,  $T_j = 125^\circ\text{C}$   
 par.:  $V_{CE}=600\text{V}$ ,  $V_{GE} = \pm 15\text{V}$ ,  $R_G = 153\Omega$

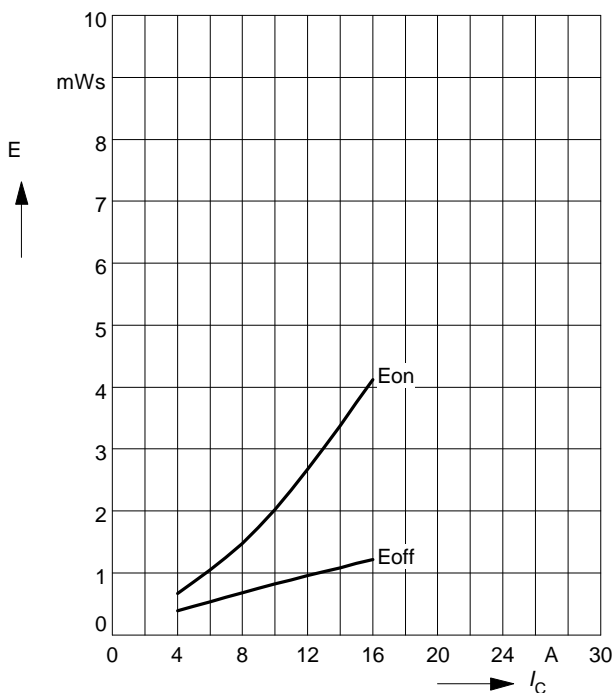

### Typ. switching losses

$E = f(R_G)$ , inductive load,  $T_j = 125^\circ\text{C}$   
 par.:  $V_{CE}=600\text{V}$ ,  $V_{GE} = \pm 15\text{V}$ ,  $I_C = 8\text{ A}$

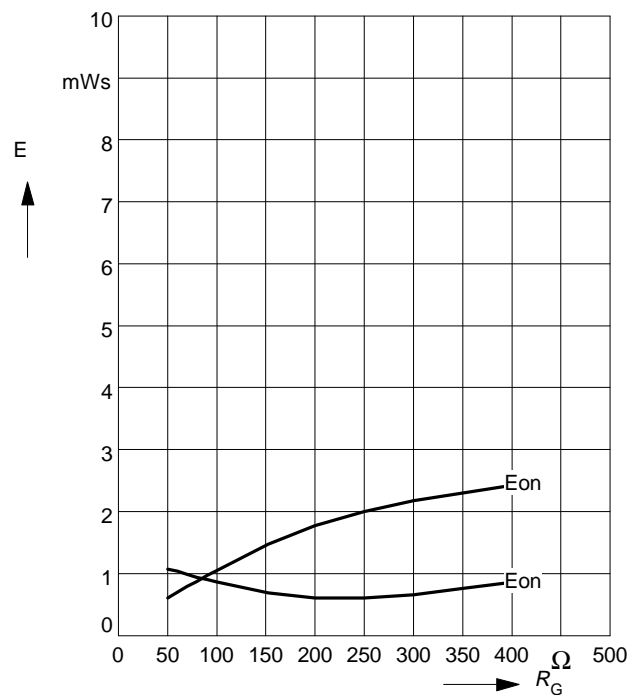

### Typ. gate charge

$V_{GE} = f(Q_{Gate})$   
 parameter:  $I_{C\ puls} = 15\ A$

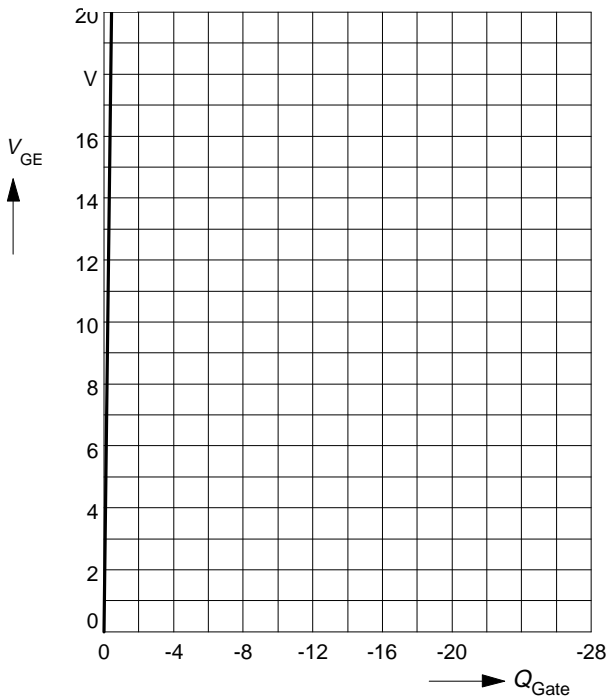

### Typ. capacitances

$C = f(V_{CE})$

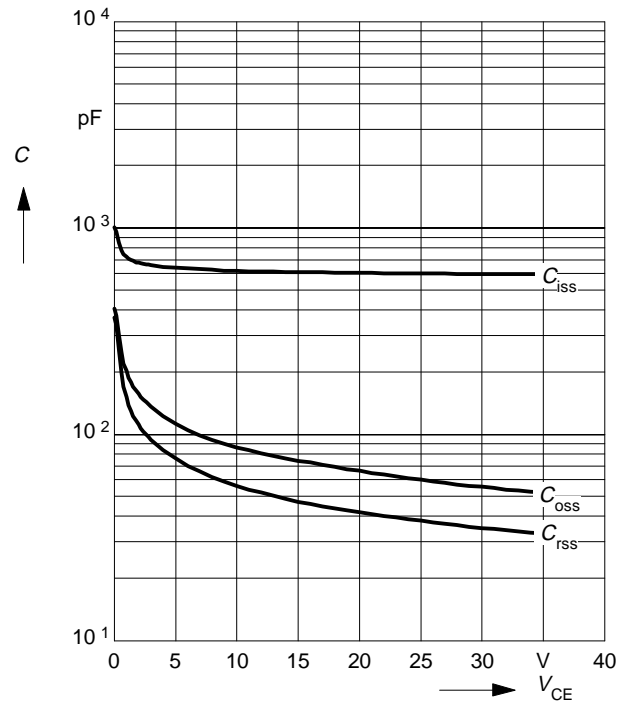

### Short circuit safe operating area

$I_{Csc} = f(V_{CE}), T_j = 150^\circ C$   
 parameter:  $V_{GE} = \pm 15\ V, t_{sc} \le 10\ \mu s, L < 25\ nH$

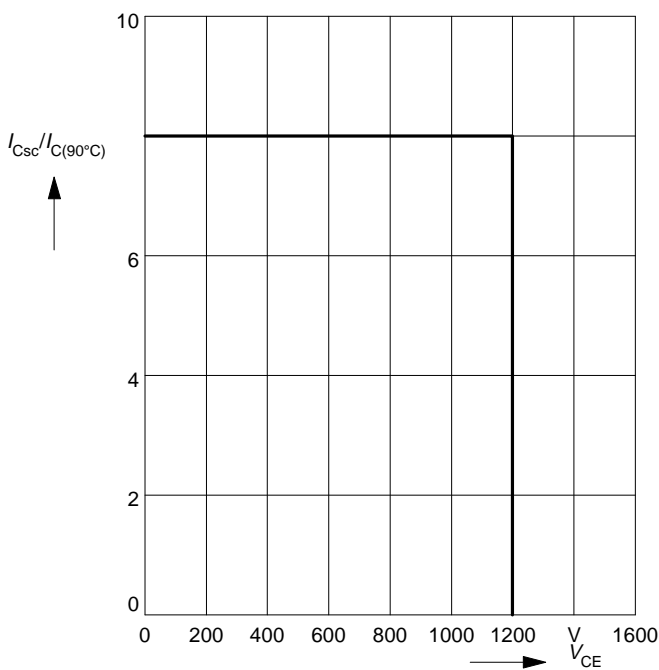

### Reverse biased safe operating area

$I_{Cpuls} = f(V_{CE}), T_j = 150^\circ C$   
 parameter:  $V_{GE} = 15\ V$

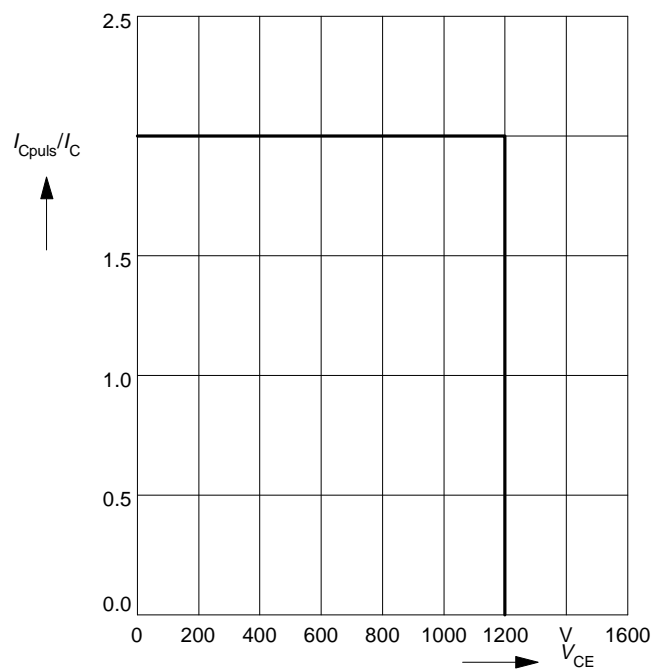



Typ. forward characteristics

$$I_F = f(V_F)$$

parameter:  $T_j$

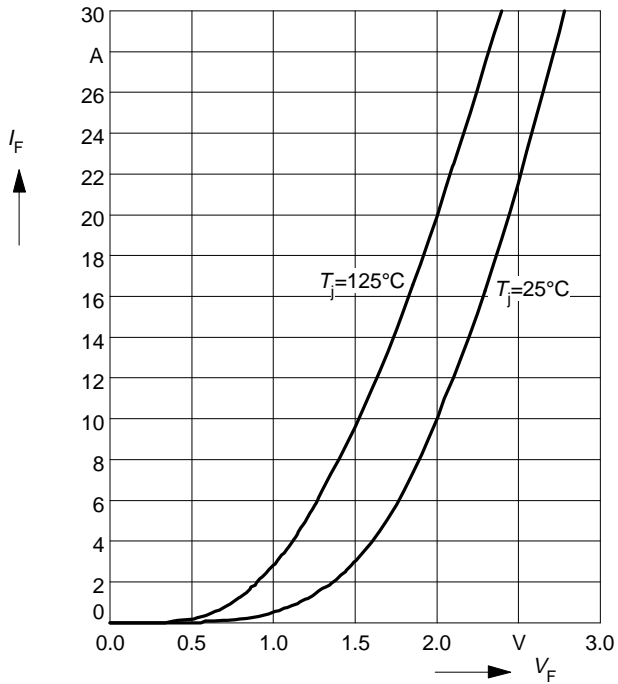

Transient thermal impedance Diode

$$Z_{thJC} = f(t_p)$$

parameter:  $D = t_p / T$

