

CMOS LDO Regulator Series for Automotive Ultra-Small Package FULL CMOS LDO Regulator

BUxxJA2MNVX-C series

General Description

BUxxJA2MNVX-C series are high-performance FULL CMOS regulators with 200mA output, which are mounted on versatile package SSON004R1010 (1.00mm x 1.00mm x 0.60mm). These device have excellent noise characteristics and load responsiveness characteristics despite its low circuit current consumption of 35µA. They are most appropriate for various applications such as power supplies for radar and camera of the automotive.

Features

- AEC-Q100 Qualified^(NoteE1)
- High Accuracy Output
- Low Current Consumption
- Compatible With Small Ceramic Capacitor($C_{IN}=C_{O}=0.47\mu F$)
- With Built-in Output Discharge Circuit
- High Ripple Rejection
- ON/OFF Control of Output Voltage
- Built-in Over Current Protection Circuit
- Built-in Thermal Shutdown Circuit
(Note1) Grade1

Key Specifications

- Input Voltage Range: 1.7V to 6.0V
- Output Voltage: 1.0V to 3.4V
- Output Voltage Accuracy: $\pm 2.0\%$ ($T_a=-40^{\circ}C$ to $125^{\circ}C$)
- Output Current: 200mA(Max)
- Standby Current: 35µA (Typ)
- Operating Temperature Range: $-40^{\circ}C$ to $+125^{\circ}C$

Package

SSON004R1010 : W(Typ) x D(Typ) x H(Max)
1.00mm x 1.00mm x 0.60mm



Applications

Radar and camera for automotive, etc.

Typical Application Circuit

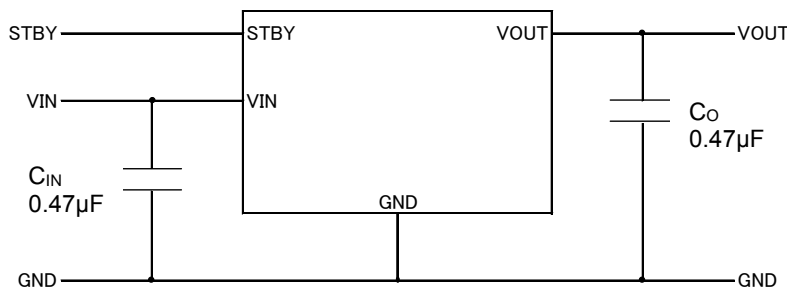

Figure 1. Application Circuit

Ordering Information

B U x x J A 2 M N V X					-	C TL
Part Number	Output Voltage 10 : 1.0V ↓ 33 : 3.3V	Output Current 200mA	Category M:Automotive	Package NVX:SSON004R1010	Product Rank C:for Automotive Packaging and forming specification TL: Embossed tape and reel	

Output Voltage	1.0V	1.2V	1.25V	1.5V	1.8V	2.5V	2.8V	2.85V	3.0V	3.3V
Part Number	BU10	BU12	BU1C	BU15	BU18	BU25	BU28	BU2J	BU30	BU33

Block Diagram

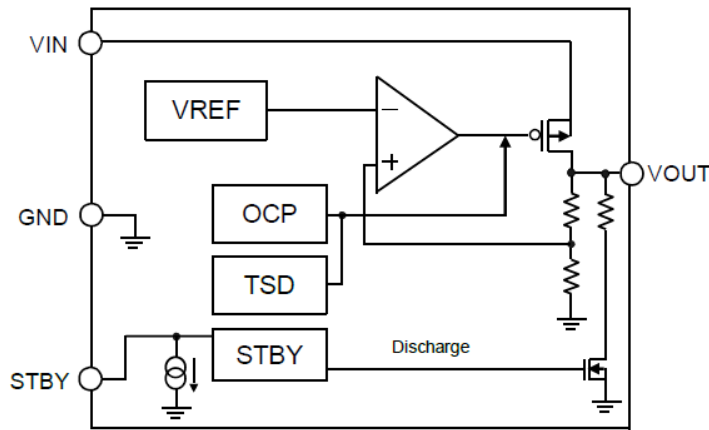
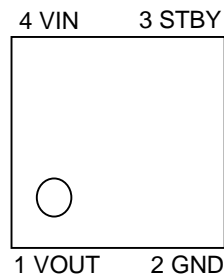

Figure 2. Block Diagram

Pin Configurations



SSON004R1010 (TOP VIEW)

Pin Descriptions

Pin No.	Pin name	Pin Function
1	VOUT	Output Voltage
2	GND	Ground
3	STBY	ON/OFF control of output voltage (High: ON, Low: OFF)
4	VIN	Power Supply Voltage
Back side	FIN	Connect to GND

Absolute Maximum Ratings (Ta=25°C)

Parameter	Symbol	Rating	Unit
Power Supply Voltage	V _{IN}	-0.3 to +6.5	V
STBY Voltage	V _{STBY}	-0.3 to +6.5	V
Power Dissipation	Pd	0.69 (Note1)	W
Operating Temperature Range	T _{opr}	-40 to +125	°C
Storage Temperature Range	T _{stg}	-55 to +150	°C
Maximum junction temperature	T _{jmax}	+150	°C

(Note1) Mounted on 70mm x 70mm x 1.6mm glass epoxy board. Reduce 5.52mW per 1°C above 25°C

Recommended Operating Range

Parameter	Symbol	Min	Max	Unit
Power Supply Voltage	V _{IN}	1.7	6.0	V
STBY Voltage	V _{STBY}	0.0	6.0	V
Maximum Output Current	I _{OUT}	-	200	mA

Recommended Operating Conditions

Parameter	Symbol	Min	Typ	Max	Unit	Conditions
Input Capacitor	C _{IN}	0.22 (Note2)	0.47	-	μF	Ceramic capacitor recommended
Output Capacitor	C _O	0.22 (Note2)	0.47	-	μF	Ceramic capacitor recommended

(Note2) Caution that the capacitance to be kept higher than this specified values under all conditions considering temperature, DC bias, etc.

Electrical Characteristics

(VIN=VOUT+1.0V^(Note3)、STBY=VIN、C_{IN}=0.47μF、C_O=0.47μF, unless otherwise specified.)

Parameter	Symbol	Limit			Unit	Conditions
		Min	Typ	Max		
[Regulator Block]						
Output Voltage 1	VOUT1	VOUT ×0.98	-	VOUT ×1.02	V	IOUT=0.01mA, VOUT≥1.8V
		VOUT -36mV	-	VOUT +36mV		IOUT=0.01mA, VOUT<1.8V
Output Voltage 2	VOUT2	VOUT ×0.97	-	VOUT ×1.03	V	IOUT=0.01mA to 200mA VOUT≥1.8V
		VOUT -54mV	-	VOUT +54mV		IOUT=0.01mA to 200mA VOUT<1.8V
Operating Current	IIN	-	35	90	μA	IOUT=0mA
Operating Current (STBY)	ISTBY	-	-	2.0	μA	STBY=0V
Ripple Rejection Ratio	RR	45	70	-	dB	VRR=-20dBv, fRR=1kHz IOUT=10mA, Ta=25°C
Dropout Voltage	VSAT	-	800	1100	mV	1.0V ≤ VOUT < 1.2V(IOUT=200mA)
		-	600	900	mV	1.2V ≤ VOUT < 1.5V(IOUT=200mA)
		-	440	830	mV	1.5V ≤ VOUT < 1.8V(IOUT=200mA)
		-	380	710	mV	1.8V ≤ VOUT < 2.5(IOUT=200mA)
		-	280	620	mV	2.5V ≤ VOUT ≤ 2.6(IOUT=200mA)
		-	260	580	mV	2.7V ≤ VOUT ≤ 2.85(IOUT=200mA)
		-	240	530	mV	2.9V ≤ VOUT ≤ 3.1V(IOUT=200mA)
-	220	490	mV	3.2V ≤ VOUT ≤ 3.4V(IOUT=200mA)		
Line Regulation	VDL	-	2	20	mV	VIN=VOUT+1.0V to 5.5V ^(Note4) IOUT=0.01mA
Load Regulation	VDLO	-	10	80	mV	IOUT=0.01mA to 100mA
[Over Current Protection (OCP) Block]						
Limit Current	ILMAX	220	400	700	mA	ILMAX@VOUT×0.95, Ta=25°C
Short Current	ISHORT	20	70	150	mA	VOUT=0V, Ta=25°C
[Standby Block]						
Discharge Resistor	RDSC	20	50	80	Ω	VIN=4.0V, STBY=0V VOUT=4.0V, Ta=25°C
STBY Pin Pull-down Current	ISTB	0.1	0.6	2.0	μA	STBY=1.5V
STBY Control Voltage	ON	VSTBH	1.2	-	6.0	V
	OFF	VSTBL	0	-	0.3	V

(Note3) VIN=2.5V for VOUT≤1.5V

(Note4) VIN=2.5V to 3.6V for VOUT≤1.5V

Reference data

BU33JA2MNVX-C

(Ta=25°C unless otherwise specified.)

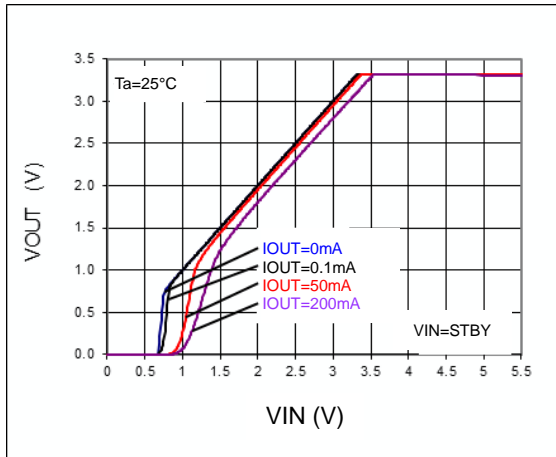

Figure 3. Output Voltage

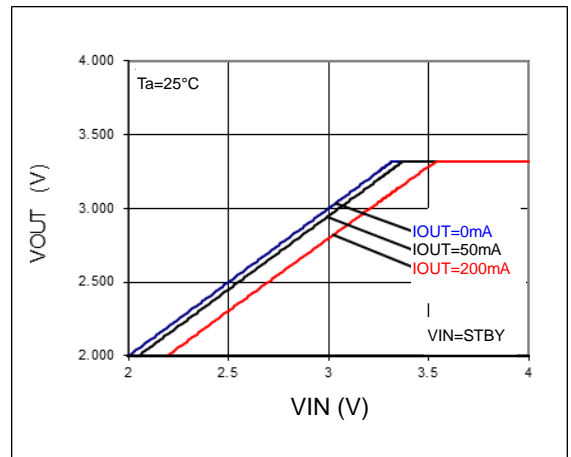

Figure 4. Output Voltage

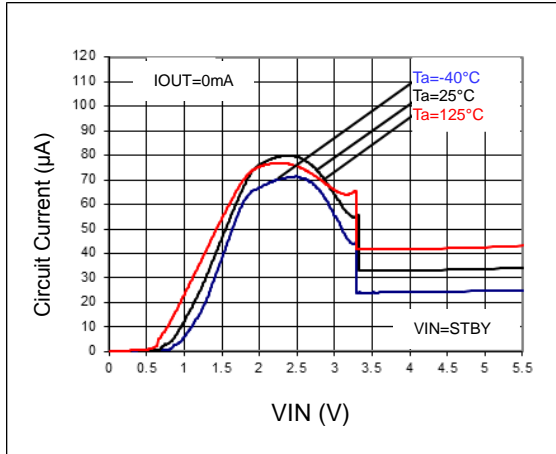

Figure 5. Circuit Current IIN

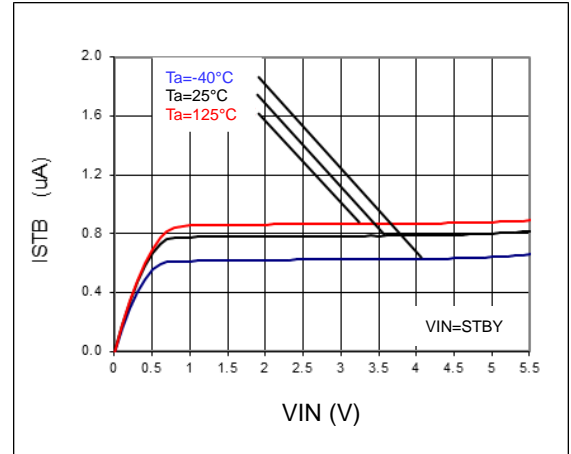

Figure 6. VSTBY - ISTB

Reference data

BU33JA2MNVX-C

(Ta=25°C unless otherwise specified.)

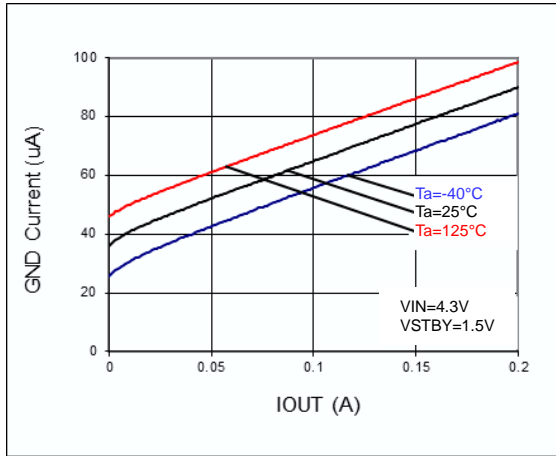

Figure 7. IOUT - IGND

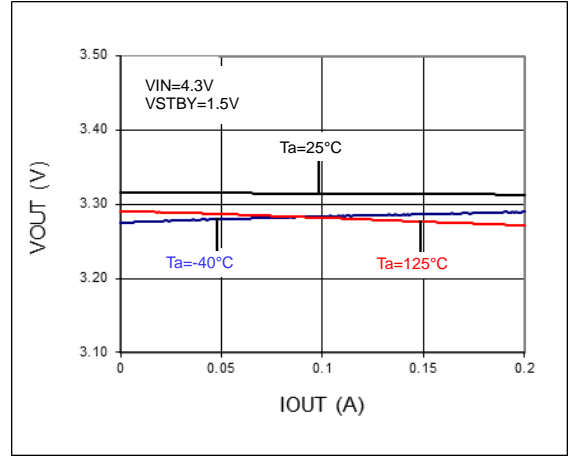

Figure 8. Load Regulation

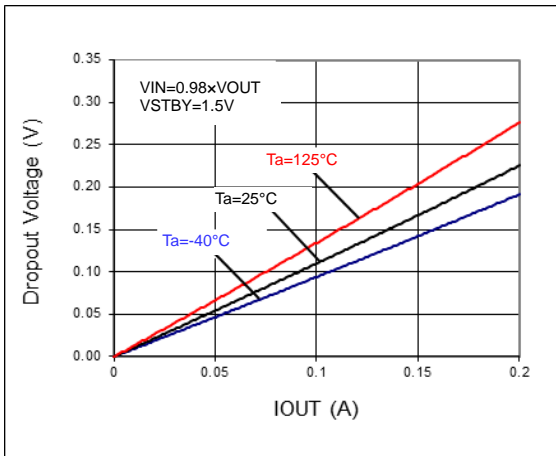

Figure 9. Dropout Voltage

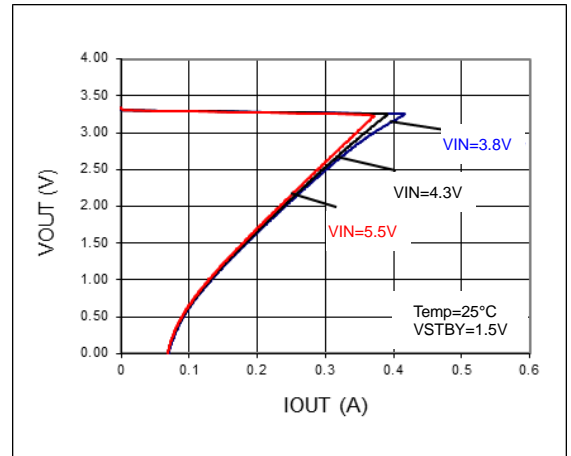

Figure 10. OCP Threshold

Reference data

BU33JA2MNVX-C

(Ta=25°C unless otherwise specified.)

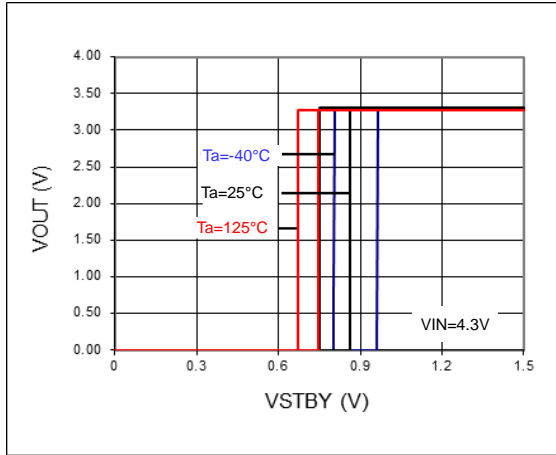

Figure 11. STBY Threshold

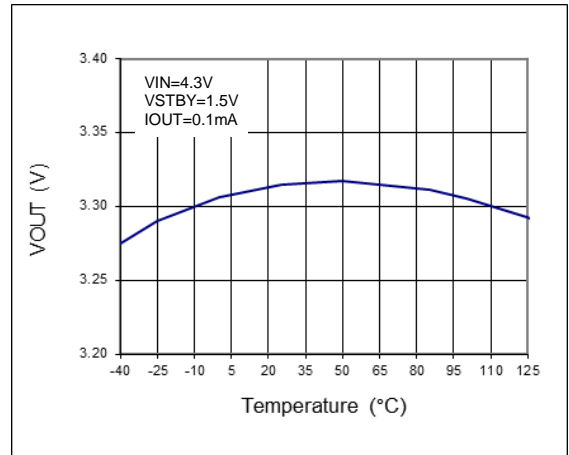

Figure 12. VOUT - Temp

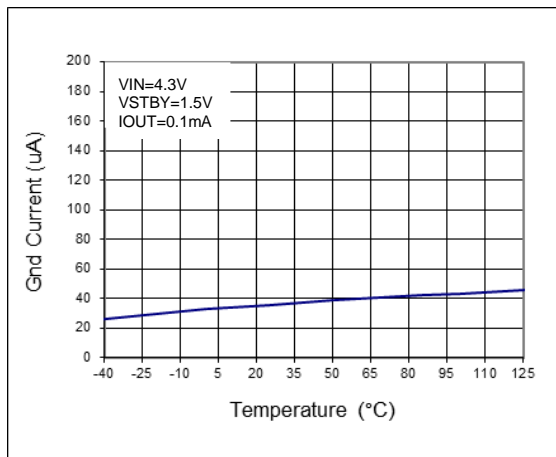

Figure 13. IGND - Temp

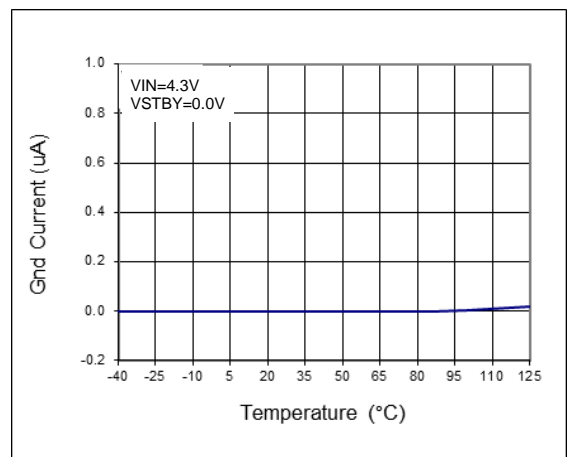

Figure 14. IGND - Temp (STBY)

Reference data

BU33JA2MNVX-C

(Ta=25°C unless otherwise specified.)

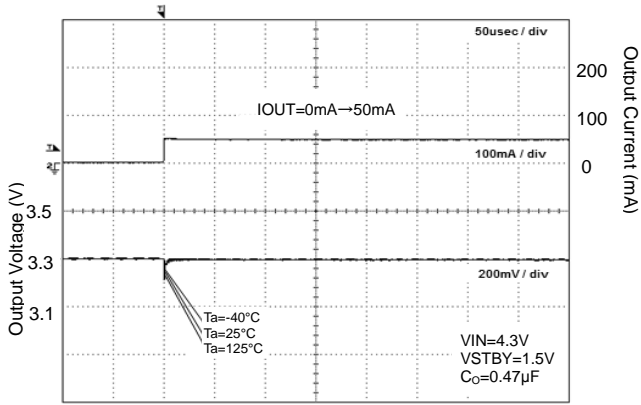

Figure 15. Load Response

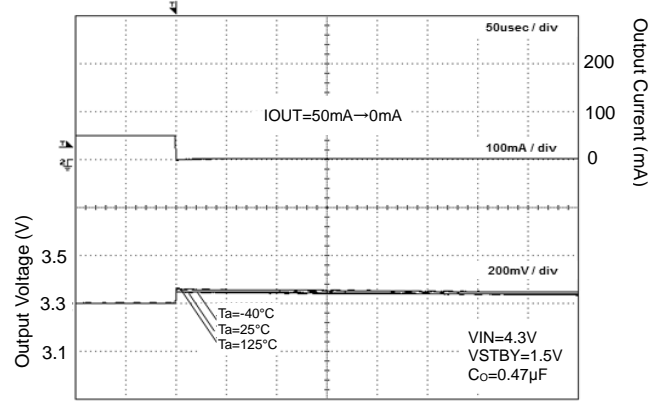

Figure 16. Load Response

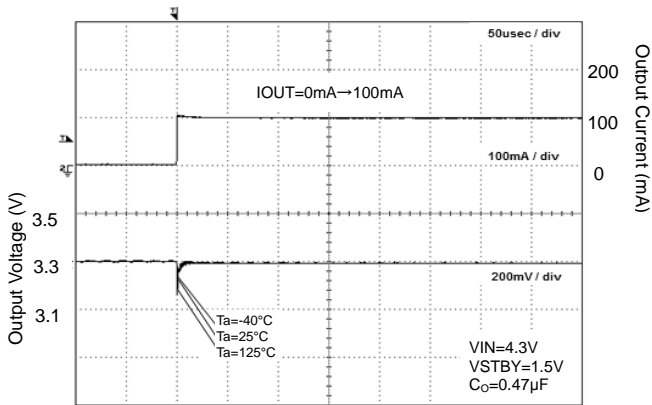

Figure 17. Load Response

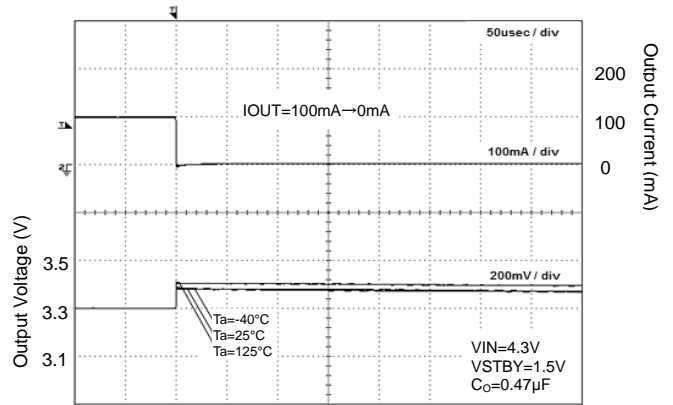

Figure 18. Load Response

Reference data

BU33JA2MNVX-C

(Ta=25°C unless otherwise specified.)

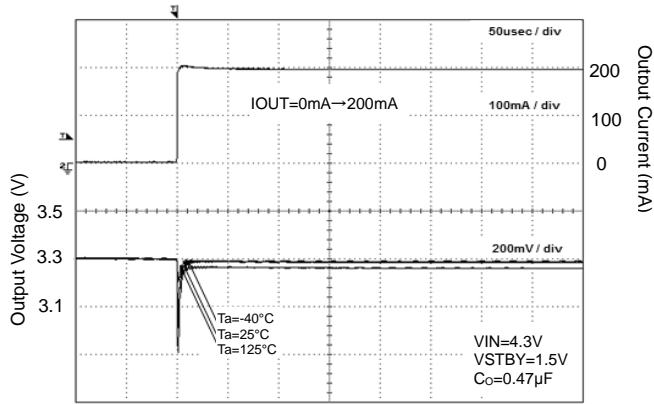

Figure 19. Load Response

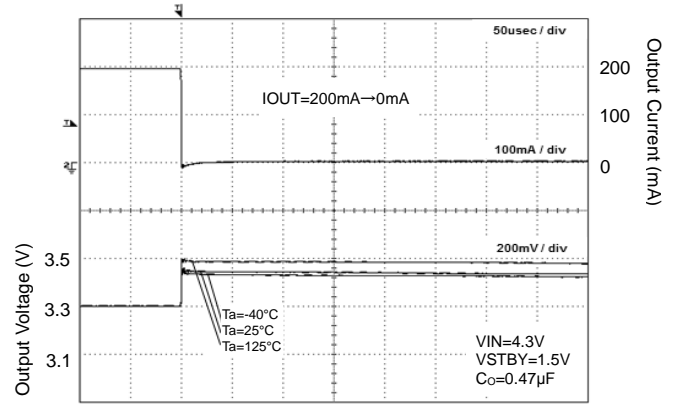

Figure 20. Load Response

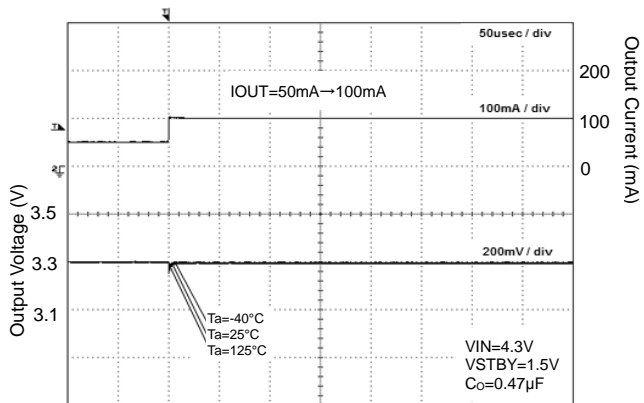

Figure 21. Load Response

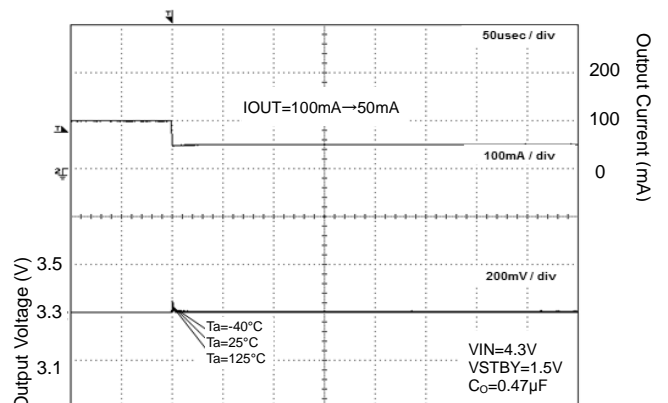

Figure 22. Load Response

Reference data

BU33JA2MNVX-C

(Ta=25°C unless otherwise specified.)

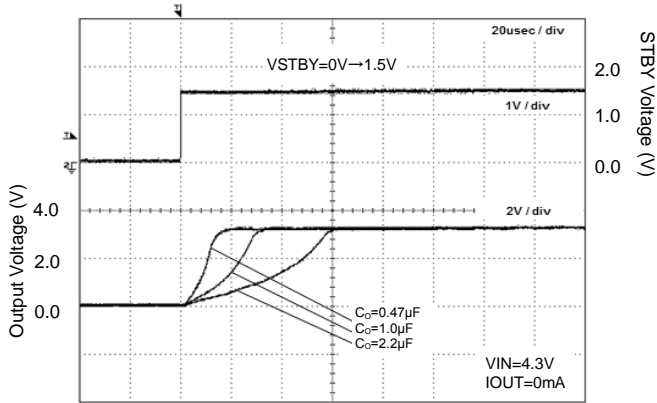

Figure 23. Start Up Time
IOUT=0mA

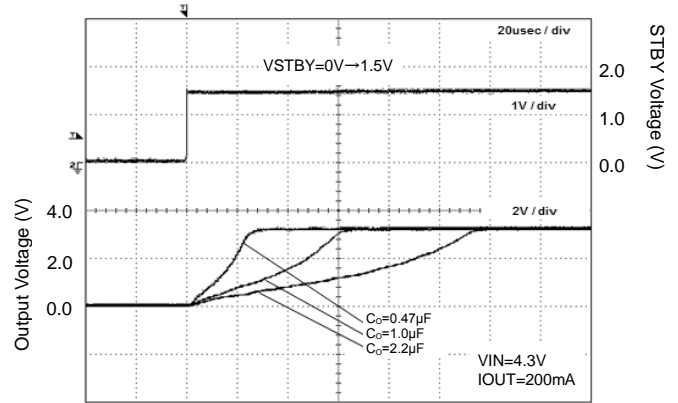

Figure 24. Start Up Time
IOUT=200mA

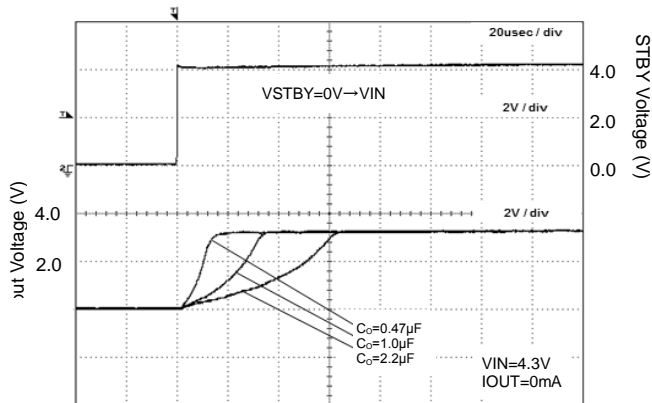

Figure 25. Start Up Time
(VIN=STBY) IOUT=0mA

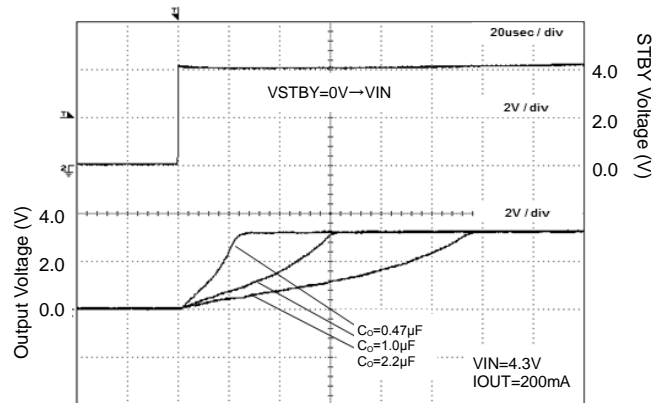

Figure 26. Start Up Time
(VIN=STBY) IOUT=200mA

Reference data

BU33JA2MNVX-C

(Ta=25°C unless otherwise specified.)

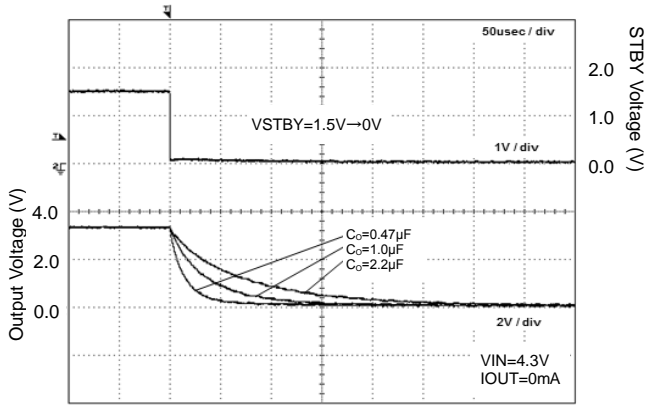

Figure 27. Discharge Time

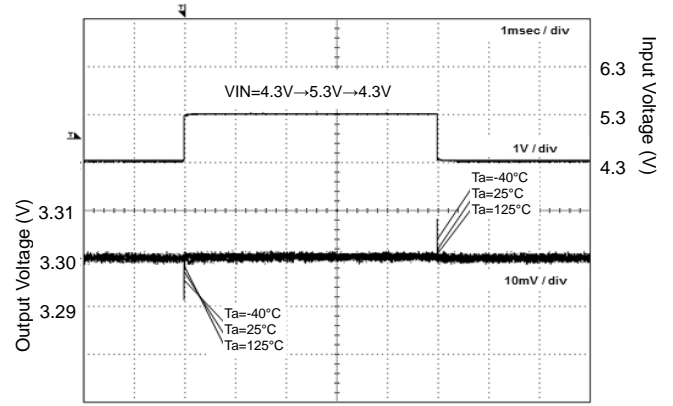

Figure 28. VIN Response

About power dissipation (Pd)

As for power dissipation, an approximate estimate of the heat reduction characteristics and internal power consumption of IC are shown, so please use these for reference. Since power dissipation changes substantially depending on the implementation conditions (board size, board thickness, metal wiring rate, number of layers and through holes, etc.), it is recommended to measure Pd on a set board. Exceeding the power dissipation of IC may lead to deterioration of the original IC performance, such as causing operation of the thermal shutdown circuit or reduction in current capability. Therefore, be sure to prepare sufficient margin within power dissipation for usage.

Calculation of the maximum internal power consumption of IC (P_{MAX})

$$P_{MAX} = (V_{IN} - V_{OUT}) \times I_{OUT(MAX)}$$

(V_{IN}: Input voltage V_{OUT}: Output voltage I_{OUT(MAX)}: Maximum output current)

Measurement conditions

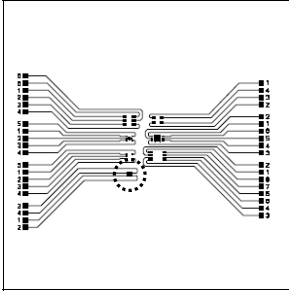
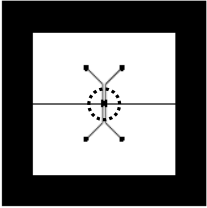
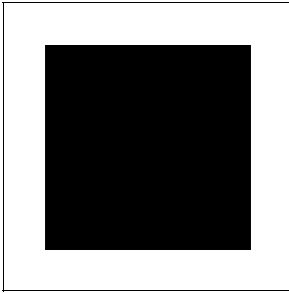
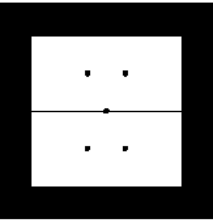
		Standard ROHM Board	Evaluation Board 1
Layout of Board for Measurement			
	IC Implementation Position		
Measurement State		With board implemented (Wind speed 0 m/s)	With board implemented (Wind speed 0 m/s)
Board Material		Glass epoxy resin (Double-side board)	Glass epoxy resin (Double-side board)
Board Size		70 mm x 70 mm x 1.6 mm	40 mm x 40 mm x 1.6 mm
Wiring Rate	Top layer	Metal (GND) wiring rate: Approx. 0%	Metal (GND) wiring rate: Approx. 50%
	Bottom layer	Metal (GND) wiring rate: Approx. 50%	Metal (GND) wiring rate: Approx. 50%
Through Hole		Diameter 0.5mm x 6 holes	Diameter 0.5mm x 25 holes
Power Dissipation		0.69W	0.48W
Thermal Resistance		θ _{ja} =178.6°C/W	θ _{ja} =256.4°C/W

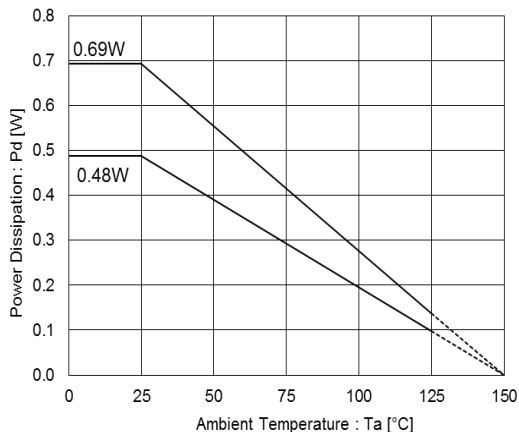

* Please design the margin that P_{MAX} will be less than the Pd (P_{MAX} < Pd) within the usage temperature range.

Figure 29. SSON004R1010 Power dissipation heat reduction characteristics (Reference)

Operation Notes

1. Absolute maximum ratings

Use of the IC exceeding the absolute maximum ratings (such as the input voltage or operating temperature range) may result in damage to the IC. Damage mode of the IC in such case can not be assumed (e.g. short mode or open mode). If operational values are expected to exceed the maximum ratings for the device, consider adding protective circuitry (such as fuses) to eliminate the risk of damaging the IC.

2. GND potential

The potential of the GND pin must be the minimum potential in the system in all operating conditions. Never connect a potential lower than GND to any pin, even if only transiently.

3. Thermal design

Use a thermal design which ensure sufficient margin to the power dissipation rating (Pd) under actual operating conditions.

4. Inter-pin shorts and mounting errors

Caution on the orientation and positioning of the IC for mounting on printed circuit boards. Improper mounting or shorts between pins may result in damage to the IC.

5. Common impedance

Wiring traces should be as short and wide as possible to minimize common impedance. Bypass capacitors should be use $\bar{\lambda}$ to keep ripple to a minimum.

6. Voltage of STBY pin

To enable standby mode for all channels, set the STBY pin to 0.3 V or less, and for normal operation, to 1.2 V or more. Setting STBY to a voltage between 0.3 and 1.2 V may cause malfunction and should be avoided. Keep transition time between high and low (or vice versa) to a minimum.

Additionally, if STBY is shorted to VIN, the IC will switch to standby mode and disable the output discharge circuit, causing a temporary voltage to remain on the output pin. If the IC is switched on again while this voltage is present, overshoot may occur on the output. Therefore, in applications where these pins are shorted, the output should always be completely discharged before turning the IC on.

7. Over-current protection circuit (OCP)

This IC features an integrated over-current and short-protection circuitry on the output to prevent destruction of the IC when the output is shorted. The OCP circuitry is designed only to protect the IC from irregular conditions (such as motor output shorts) and is not designed to be used as an active security device for the application. Therefore, applications should not be designed under the assumption that this circuitry will engage.

8. Thermal shutdown circuit (TSD)

This IC also features a thermal shutdown circuit that is designed to turn the output off when the junction temperature of the IC exceeds approximately 150°C. This feature is intended to protect the IC only in the event of thermal overload and is not designed to guarantee operation or act as an active security device for the application. Therefore, applications should not be designed under the assumption that this circuitry will engage.

9. Input/output capacitor

Capacitors must be connected between the input/output pins and GND for stable operation, and should be physically mounted as close to the IC pins as possible. The input capacitor helps to counteract increases in power supply impedance, and increases stability in applications with long or winding power supply traces. The output capacitance value is directly related to the overall stability and transient response of the regulator, and should be set to the largest possible value for the application to increase these characteristics. During design, keep in mind that in general, ceramic capacitors have a wide range of tolerances, temperature coefficients and DC bias characteristics, and that their capacitance values tend to decrease over time. Confirm these details before choosing appropriate capacitors for your application. (Refer to the technical note of the intended ceramic capacitors.)

10. About the equivalent series resistance (ESR) of a ceramic capacitor

Capacitors generally have ESR (equivalent series resistance) and it operates stably in the ESR-IOUT area shown on the below. Since ceramic capacitors, tantalum capacitors, electrolytic capacitors, etc. generally have different ESR, please check the ESR of the capacitor to be used and use it within the stability area range shown in the right graph for evaluation of the actual application.

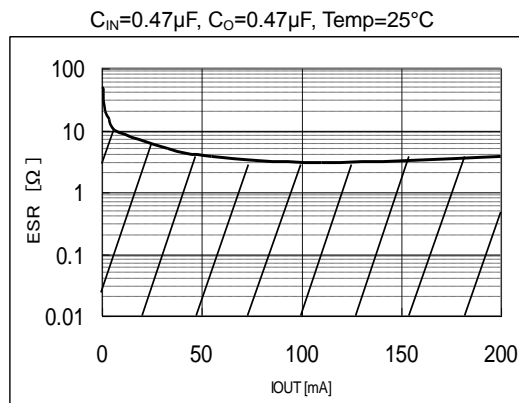

Figure 30. Stable region

Input/Output Capacitor

It is recommended that an input capacitor is placed near pins between the VIN pin and GND as well as an output capacitor between the VOUT pin and GND. The input is valid when the power supply impedance is high or when the PCB trace has significant length. For the output capacitor, the greater the capacitance, the more stable the output will be depending on the load and line voltage variations. However, please check the actual functionality of this capacitor by mounting it on a board for the actual application. Ceramic capacitors usually have different, thermal and equivalent series resistance characteristics, and may degrade gradually over continued use. For additional details, please check with the manufacturer, and select the best ceramic capacitor for your application.

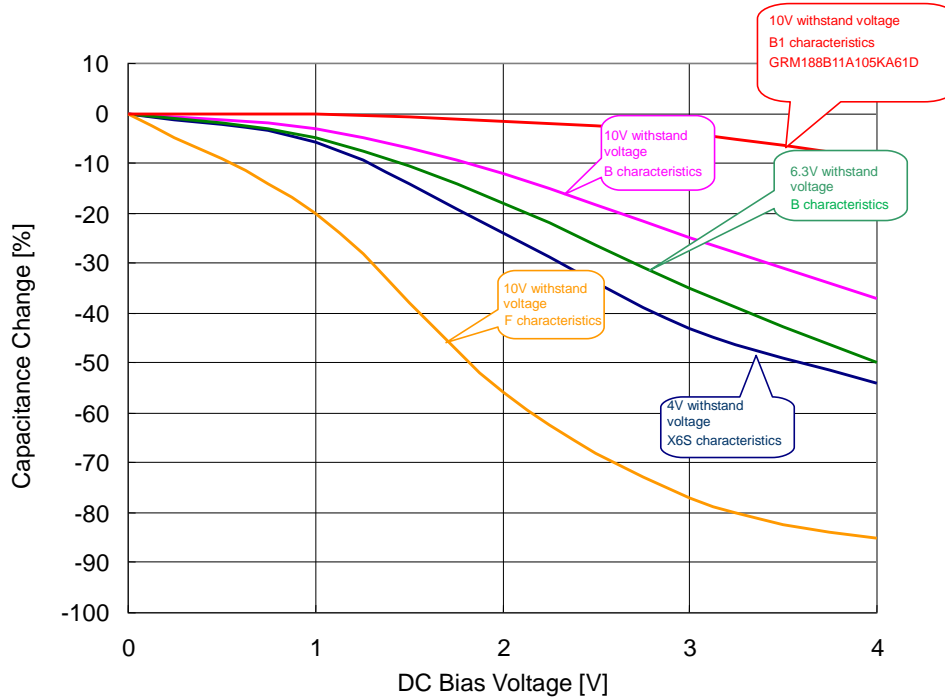

Figure 31. Capacity-bias characteristics

I/O Equivalence Circuits

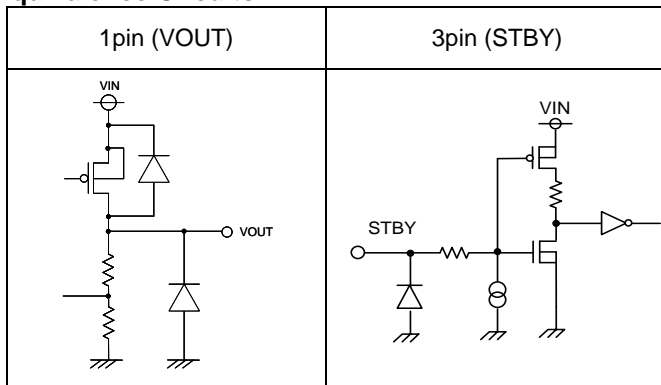
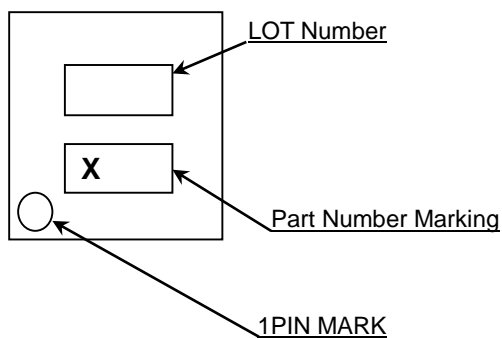

Figure 32. Input / Output equivalent circuit

Marking Diagram

SSON004R1010 (TOP VIEW)



Marking	5	4	3	2	Q	1	U	0	Y	R
Output Voltage	1.0V	1.2V	1.25V	1.5V	1.8V	2.5V	2.8V	2.85V	3.0V	3.3V
Part Number	BU10	BU12	BU1C	BU15	BU18	BU25	BU28	BU2J	BU30	BU33

Physical Dimension Tape and Reel Information

Package Name	SSON004R1010
--------------	--------------

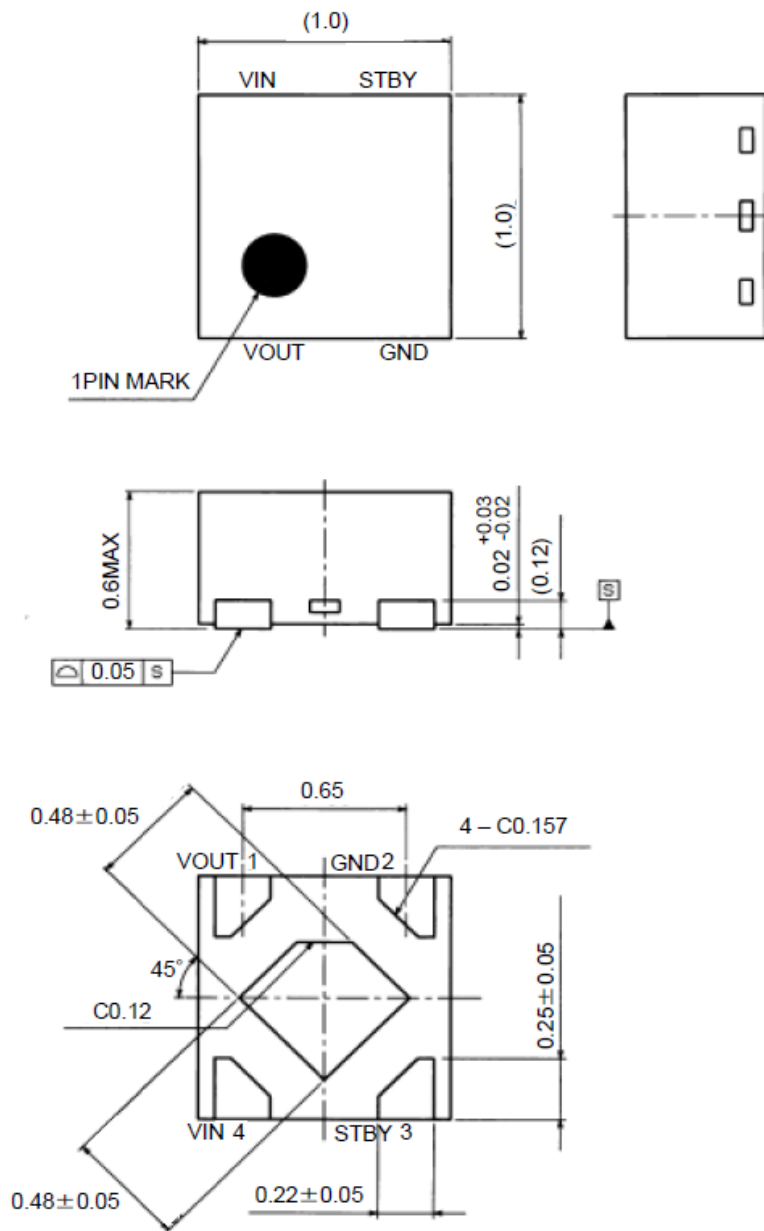

(UNIT : mm)

< Tape and Reel Information >

Tape	Embossed carrier tape
Quantity	5000pcs
Direction of feed	TL The direction is the pin 1 of product is at the lower left when you hold reel on the left hand and you pull out the tape on the right hand

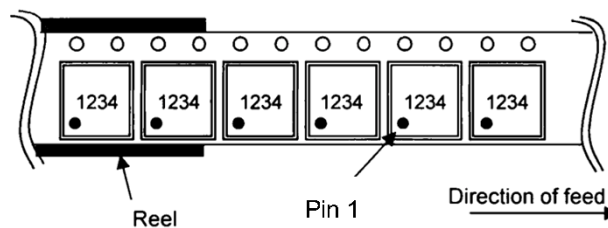

Revision History

Date	Revision	Changes
26.Dec.2014	001	New Release.
27.Aug.2015	002	P2 Add Line up
11.Apr.2016	003	Applied the ROHM Standard Style and improved understandability. Add Equivalence Circuits

Notice

Precaution on using ROHM Products

1. If you intend to use our Products in devices requiring extremely high reliability (such as medical equipment ^(Note 1), aircraft/spacecraft, nuclear power controllers, etc.) and whose malfunction or failure may cause loss of human life, bodily injury or serious damage to property ("Specific Applications"), please consult with the ROHM sales representative in advance. Unless otherwise agreed in writing by ROHM in advance, ROHM shall not be in any way responsible or liable for any damages, expenses or losses incurred by you or third parties arising from the use of any ROHM's Products for Specific Applications.

(Note1) Medical Equipment Classification of the Specific Applications

JAPAN	USA	EU	CHINA
CLASS III	CLASS III	CLASS II b	CLASS III
CLASS IV		CLASS III	

2. ROHM designs and manufactures its Products subject to strict quality control system. However, semiconductor products can fail or malfunction at a certain rate. Please be sure to implement, at your own responsibilities, adequate safety measures including but not limited to fail-safe design against the physical injury, damage to any property, which a failure or malfunction of our Products may cause. The following are examples of safety measures:
 - [a] Installation of protection circuits or other protective devices to improve system safety
 - [b] Installation of redundant circuits to reduce the impact of single or multiple circuit failure
3. Our Products are not designed under any special or extraordinary environments or conditions, as exemplified below. Accordingly, ROHM shall not be in any way responsible or liable for any damages, expenses or losses arising from the use of any ROHM's Products under any special or extraordinary environments or conditions. If you intend to use our Products under any special or extraordinary environments or conditions (as exemplified below), your independent verification and confirmation of product performance, reliability, etc. prior to use, must be necessary:
 - [a] Use of our Products in any types of liquid, including water, oils, chemicals, and organic solvents
 - [b] Use of our Products outdoors or in places where the Products are exposed to direct sunlight or dust
 - [c] Use of our Products in places where the Products are exposed to sea wind or corrosive gases, including Cl₂, H₂S, NH₃, SO₂, and NO₂
 - [d] Use of our Products in places where the Products are exposed to static electricity or electromagnetic waves
 - [e] Use of our Products in proximity to heat-producing components, plastic cords, or other flammable items
 - [f] Sealing or coating our Products with resin or other coating materials
 - [g] Use of our Products without cleaning residue of flux (even if you use no-clean type fluxes, cleaning residue of flux is recommended); or Washing our Products by using water or water-soluble cleaning agents for cleaning residue after soldering
 - [h] Use of the Products in places subject to dew condensation
4. The Products are not subject to radiation-proof design.
5. Please verify and confirm characteristics of the final or mounted products in using the Products.
6. In particular, if a transient load (a large amount of load applied in a short period of time, such as pulse. is applied, confirmation of performance characteristics after on-board mounting is strongly recommended. Avoid applying power exceeding normal rated power; exceeding the power rating under steady-state loading condition may negatively affect product performance and reliability.
7. De-rate Power Dissipation depending on ambient temperature. When used in sealed area, confirm that it is the use in the range that does not exceed the maximum junction temperature.
8. Confirm that operation temperature is within the specified range described in the product specification.
9. ROHM shall not be in any way responsible or liable for failure induced under deviant condition from what is defined in this document.

Precaution for Mounting / Circuit board design

1. When a highly active halogenous (chlorine, bromine, etc.) flux is used, the residue of flux may negatively affect product performance and reliability.
2. In principle, the reflow soldering method must be used on a surface-mount products, the flow soldering method must be used on a through hole mount products. If the flow soldering method is preferred on a surface-mount products, please consult with the ROHM representative in advance.

For details, please refer to ROHM Mounting specification

Precautions Regarding Application Examples and External Circuits

1. If change is made to the constant of an external circuit, please allow a sufficient margin considering variations of the characteristics of the Products and external components, including transient characteristics, as well as static characteristics.
2. You agree that application notes, reference designs, and associated data and information contained in this document are presented only as guidance for Products use. Therefore, in case you use such information, you are solely responsible for it and you must exercise your own independent verification and judgment in the use of such information contained in this document. ROHM shall not be in any way responsible or liable for any damages, expenses or losses incurred by you or third parties arising from the use of such information.

Precaution for Electrostatic

This Product is electrostatic sensitive product, which may be damaged due to electrostatic discharge. Please take proper caution in your manufacturing process and storage so that voltage exceeding the Products maximum rating will not be applied to Products. Please take special care under dry condition (e.g. Grounding of human body / equipment / solder iron, isolation from charged objects, setting of Ionizer, friction prevention and temperature / humidity control).

Precaution for Storage / Transportation

1. Product performance and soldered connections may deteriorate if the Products are stored in the places where:
 - [a] the Products are exposed to sea winds or corrosive gases, including Cl₂, H₂S, NH₃, SO₂, and NO₂
 - [b] the temperature or humidity exceeds those recommended by ROHM
 - [c] the Products are exposed to direct sunshine or condensation
 - [d] the Products are exposed to high Electrostatic
2. Even under ROHM recommended storage condition, solderability of products out of recommended storage time period may be degraded. It is strongly recommended to confirm solderability before using Products of which storage time is exceeding the recommended storage time period.
3. Store / transport cartons in the correct direction, which is indicated on a carton with a symbol. Otherwise bent leads may occur due to excessive stress applied when dropping of a carton.
4. Use Products within the specified time after opening a humidity barrier bag. Baking is required before using Products of which storage time is exceeding the recommended storage time period.

Precaution for Product Label

A two-dimensional barcode printed on ROHM Products label is for ROHM's internal use only.

Precaution for Disposition

When disposing Products please dispose them properly using an authorized industry waste company.

Precaution for Foreign Exchange and Foreign Trade act

Since concerned goods might be fallen under listed items of export control prescribed by Foreign exchange and Foreign trade act, please consult with ROHM in case of export.

Precaution Regarding Intellectual Property Rights

1. All information and data including but not limited to application example contained in this document is for reference only. ROHM does not warrant that foregoing information or data will not infringe any intellectual property rights or any other rights of any third party regarding such information or data.
2. ROHM shall not have any obligations where the claims, actions or demands arising from the combination of the Products with other articles such as components, circuits, systems or external equipment (including software).
3. No license, expressly or implied, is granted hereby under any intellectual property rights or other rights of ROHM or any third parties with respect to the Products or the information contained in this document. Provided, however, that ROHM will not assert its intellectual property rights or other rights against you or your customers to the extent necessary to manufacture or sell products containing the Products, subject to the terms and conditions herein.

Other Precaution

1. This document may not be reprinted or reproduced, in whole or in part, without prior written consent of ROHM.
2. The Products may not be disassembled, converted, modified, reproduced or otherwise changed without prior written consent of ROHM.
3. In no event shall you use in any way whatsoever the Products and the related technical information contained in the Products or this document for any military purposes, including but not limited to, the development of mass-destruction weapons.
4. The proper names of companies or products described in this document are trademarks or registered trademarks of ROHM, its affiliated companies or third parties.

General Precaution

1. Before you use our Products, you are requested to carefully read this document and fully understand its contents. ROHM shall not be in any way responsible or liable for failure, malfunction or accident arising from the use of any ROHM's Products against warning, caution or note contained in this document.
2. All information contained in this document is current as of the issuing date and subject to change without any prior notice. Before purchasing or using ROHM's Products, please confirm the latest information with a ROHM sales representative.
3. The information contained in this document is provided on an "as is" basis and ROHM does not warrant that all information contained in this document is accurate and/or error-free. ROHM shall not be in any way responsible or liable for any damages, expenses or losses incurred by you or third parties resulting from inaccuracy or errors of or concerning such information.



BU10JA2MNVX-C - Web Page

[Distribution Inventory](#)

Part Number	BU10JA2MNVX-C
Package	SSON004R1010
Unit Quantity	5000
Minimum Package Quantity	5000
Packing Type	Taping
Constitution Materials List	inquiry
RoHS	Yes