

150V Radiation Hard power MOSFET

BUY15CS45B-01(ES)

Features

- LOW $R_{DS(on)}$
- Single Event Effect (SEE) hardened
LET 73, Range: 253 μ m (Pb) LET 55, Range: 90 μ m (Xe)
 $V_{GS} = -10V, V_{DS} = 150V$ $V_{GS} = -15V, V_{DS} = 150V$
 $V_{GS} = -15V, V_{DS} = 80V$ $V_{GS} = -20V, V_{DS} = 100V$
- Total Ionisation Dose (TID) hardened
100 kRad approved (Level R)
- Hermetically sealed
- N-channel

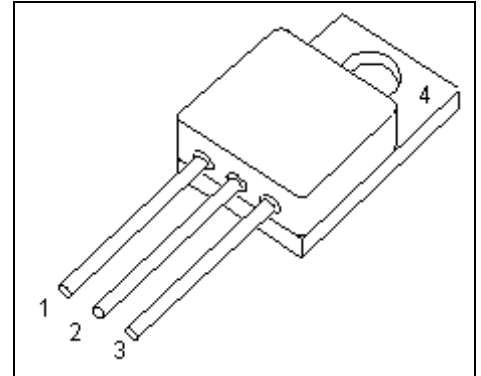

Product validation

-  **ESA Space Qualified**
ESCC Detail Spec. No.: 5205/031
Type Variant No. 04

Description

Table 1 **Product information**

Type	Comment	Pin Configuration				Package
		1	2	3	4	
BUY15CS45B-01(ES)	For flight use	D	G	S	Not connected	TO-254AA
BUY15CS45B-01(P) ¹	Not for flight use ¹					

¹ (P) parts have the same fit, form and function as (ES) parts,
no radiation hardness; no screening acc. to Chart F3 in ESCC Generic Specification No. 5000

Table of contents

Features 1

Product validation 1

Description 1

Table of contents 2

1 Maximum ratings 3

2 Thermal characteristics 4

3 Electrical characteristics 5

4 Radiation characteristics 6

5 Electrical characteristics diagrams 7

6 Package outlines 10

Maximum ratings

1 Maximum ratings

Table 2 Maximum ratings

Parameter	Symbol	Values			Unit	Note / Test Condition
		Min.	Typ.	Max.		
Drain source voltage	V_{DS}	-	-	150	V	
Gate source voltage	V_{GS}	-20	-	20	V	static
Drain gate voltage	V_{DG}	-	-	150	V	
Continuous drain current ¹	I_D	-	-	45 35	A	$T_c = 25\text{ °C}$ $T_c = 100\text{ °C}$
Continuous source current	I_S	-	-	45	A	
Drain current pulsed	I_{DM}	-	-	180	Apk	t_p limited by $T_{j,max}$
Total power dissipation ²	P_{tot}	-	-	208	W	$T_c \leq 25\text{ °C}$
Operating and storage temperature	T_{op}	-55	-	150	°C	
Avalanche energy	E_{AS}	-	-	380	mJ	

¹ Limited by package

² For $T_c > 25\text{ °C}$ derating is required.

Thermal characteristics

2 Thermal characteristics

Table 3 Thermal characteristics

Parameter	Symbol	Values			Unit	Note / Test Condition
		Min.	Typ.	Max.		
Thermal resistance, junction - case	$R_{th,Jc}$	-	-	0.6	K/W	
Soldering temperature	T_{sol}	-	-	250	°C	Duration 10 seconds maximum and the same terminal shall not be resoldered until 3 minutes have elapsed.

Electrical characteristics

3 Electrical characteristics

at $T_A=25^\circ\text{C}$, unless otherwise specified

Table 4 Static characteristics

Parameter	Symbol	Values			Unit	Note / Test Condition
		Min.	Typ.	Max.		
Drain-source breakdown voltage	BV_{DSS}	150	-	-	V	$I_D = 0.25\text{mA}$, $V_{GS} = 0\text{V}$
Temperature coefficient of BV_{DSS}	$\Delta BV_{DSS}/\Delta T_J$	-	0.2	-	V/ $^\circ\text{C}$	
Gate threshold voltage	$V_{GS(th)}$	2	-	4	V	$I_D = 1.0\text{mA}$, $V_{DS} \geq V_{GS}$, $T_A = 25^\circ\text{C}$
		1.5	-	-		$I_D = 1.0\text{mA}$, $V_{DS} \geq V_{GS}$, $T_A = 125^\circ\text{C}$
		-	-	5		$I_D = 1.0\text{mA}$, $V_{DS} \geq V_{GS}$, $T_A = -55^\circ\text{C}$
Gate to source leakage current	I_{GSS}	-100	-	100	nA	$V_{DS} = 0\text{V}$, $V_{GS} = \pm 20\text{V}$, $T_A = 25^\circ\text{C}$
		-200	-	200		$V_{DS} = 0\text{V}$, $V_{GS} = \pm 20\text{V}$, $T_A = 125^\circ\text{C}$
Zero gate voltage drain current	I_{DSS}	-	-	25	μA	$V_{DS} = 120\text{V}$, $V_{GS} = 0\text{V}$, $T_A = 25^\circ\text{C}$
		-	-	250		$V_{DS} = 120\text{V}$, $V_{GS} = 0\text{V}$, $T_A = 125^\circ\text{C}$
Drain source on-state resistance ¹	$R_{DS(ON)}$	-	23	27	m Ω	$V_{GS} = 10\text{V}$, $I_D = 35\text{A}$, $T_A = 25^\circ\text{C}$
		-	-	53		$V_{GS} = 10\text{V}$, $I_D = 35\text{A}$, $T_A = 125^\circ\text{C}$
Diode forward voltage ^{1,2}	V_{SD}	-	-	1.4	V	$V_{GS} = 0\text{V}$, $I_S = 45\text{A}$

Table 5 Dynamic characteristics

Parameter	Symbol	Values			Unit	Note / Test Condition
		Min.	Typ.	Max.		
Turn-on delay time	$t_{d(ON)}$	-	25	45	ns	$V_{DD} = 50\% V_{DS}$, $I_D = 35\text{A}$, $R_G = 4.7\Omega$
Rise time	t_r	-	35	95	ns	$V_{DD} = 50\% V_{DS}$, $I_D = 35\text{A}$, $R_G = 4.7\Omega$
Turn-off delay time	$t_{d(OFF)}$	-	50	60	ns	$V_{DD} = 50\% V_{DS}$, $I_D = 35\text{A}$, $R_G = 4.7\Omega$
Fall time	t_f	-	20	100	ns	$V_{DD} = 50\% V_{DS}$, $I_D = 35\text{A}$, $R_G = 4.7\Omega$
Reverse recovery time	t_{rr}	-	310	350	ns	$V_{DD} \leq 50\text{V}$, $I_D = 45\text{A}$
Common source input capacitance	C_{iss}	2.0	4.0	6.0	nF	$V_{DS} = 100\text{V}$, $V_{GS} = 0\text{V}$, $f = 1.0\text{MHz}$
Common source output capacitance	C_{oss}	360	480	600	pF	$V_{DS} = 100\text{V}$, $V_{GS} = 0\text{V}$, $f = 1.0\text{MHz}$
Common source reverse transfer capacitance	C_{rss}	60	83	100	pF	$V_{DS} = 100\text{V}$, $V_{GS} = 0\text{V}$, $f = 1.0\text{MHz}$
Gate resistance	R_G	-	0.8	-	Ω	$f = 1.0\text{MHz}$, open drain
Total gate charge	Q_G	-	75	100	nC	$V_{DD} = 50\% V_{DS}$, $V_{GS} = 10\text{V}$, $I_D = 45\text{A}$

¹ Pulsed measurement: Pulse Width < 300 μs , Duty Cycle < 2.0%.

² Measured within 2.0 mm of case

Radiation characteristics

4 Radiation characteristics

Infineon radiation hard power MOSFETs are tested to verify their radiation hardness capability. Every manufacturing wafer lot is tested for total dose steady-state irradiation according to the ESCC Basic Specification No. 22900. The following bias condition is used during irradiation testing:

- $V_{GS} = +15V$
- $V_{DS} = 0V$

Table 6 Electrical characteristics at $T_A=25^\circ C$, post Total Dose Irradiation

Parameter	Symbol	100 kRad(Si)			Unit	Note / Test Condition
		Drift Values	Absolute			
			Min.	Max.		
Drain-source breakdown voltage	BV_{DSS}	$\pm 20\%$	150	-	V	$I_D = 0.25mA, V_{GS} = 0V$
Gate threshold voltage	$V_{GS(th)}$	+10%, -50%	2	4	V	$I_D = 1.0mA, V_{DS} \geq V_{GS}$
Gate to source leakage current	I_{GSS}	$\pm 20\%$	-100	100	nA	$V_{DS} = 0V, V_{GS} = +/- 20V$
Zero gate voltage drain current	I_{DSS}	-	-	25	μA	$V_{DS} = 120V, V_{GS} = 0V$
Drain source on-state resistance ¹	$R_{DS(ON)}$	$\pm 20\%$	-	27	m Ω	$V_{GS} = 10V, I_D = 35A$
Diode forward voltage ^{1,2}	V_{SD}	$\pm 10\%$	-	1.4	V	$V_{GS} = 0V, I_S = 45A$

Infineon radiation hard power MOSFETs have been characterized in heavy ion environments for Single Event Effects (SEE) according to the ESCC Basic Specification No. 25100

Table 7 Typical Single Event Effect safe operating area

Ion	LET [MeV/(mg/cm ²)]	Range [μm]	V_{DS} [V]				
			$V_{GS} = 0V$	$V_{GS} = -5V$	$V_{GS} = -10V$	$V_{GS} = -15V$	$V_{GS} = -20V$
Xe	$55 \pm 5\%$	$90 \pm 5\%$	150	150	150	150	100
Pb	$73 \pm 5\%$	$253 \pm 5\%$	150	150	150	80	-

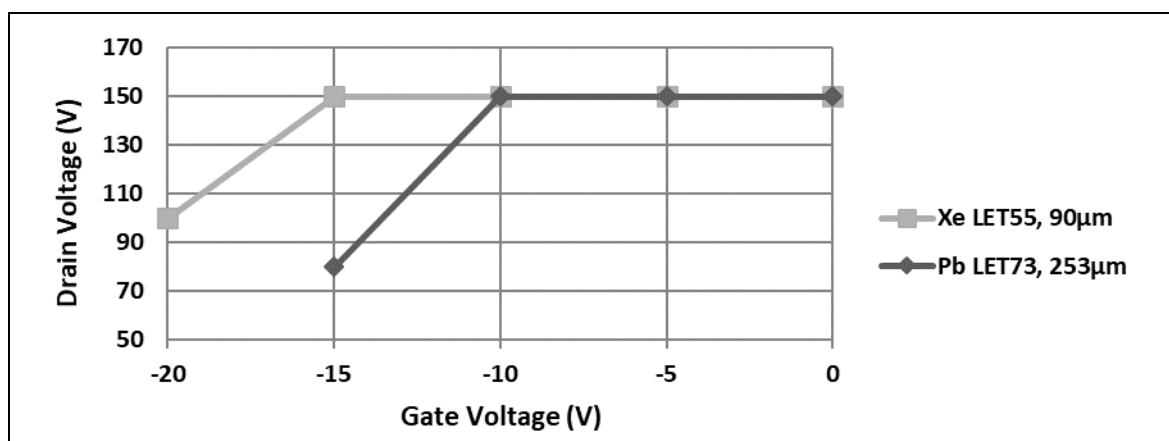

¹ Pulsed measurement: Pulse Width < 300 μs , Duty Cycle < 2.0%.

² Measured within 2.0 mm of case

5 Electrical characteristics diagrams

Diagram 1: Safe operating area

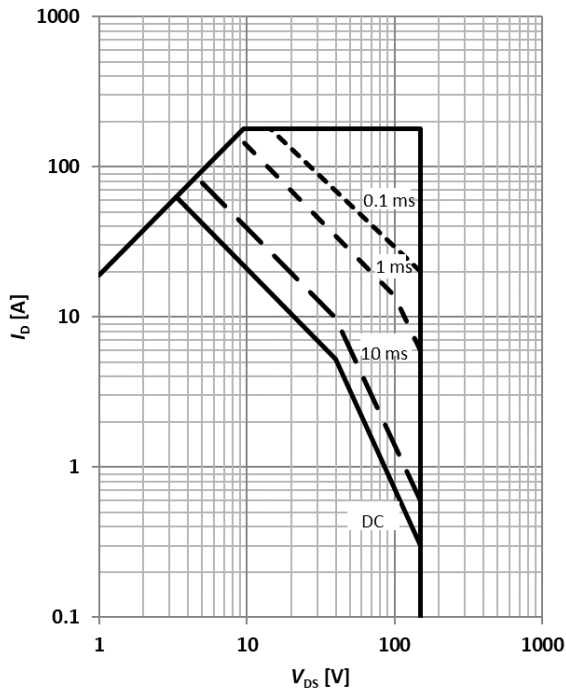

$I_D = f(V_{DS}); T_C = 25^\circ\text{C}; D=0; \text{parameter: } t_p$

Diagram 2: Max. transient thermal impedance

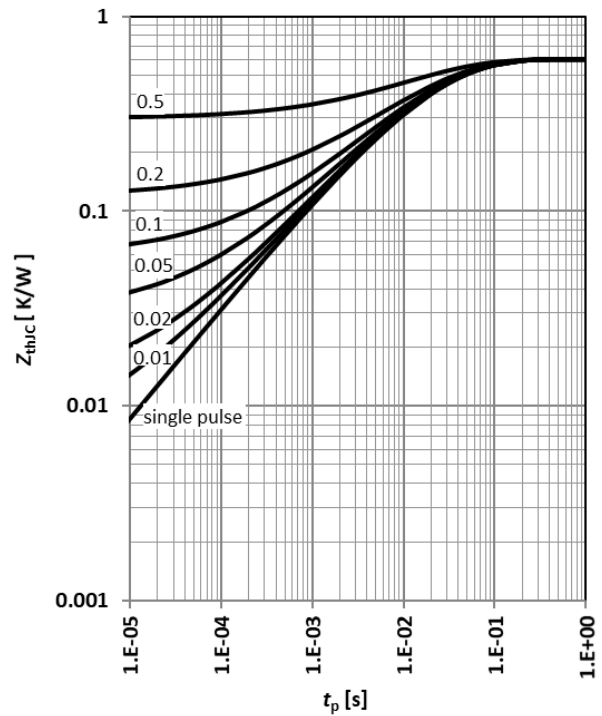

$Z_{thJC} = f(t_p); \text{parameter: } D = t_p/T$

Diagram 3: Typ. output characteristics

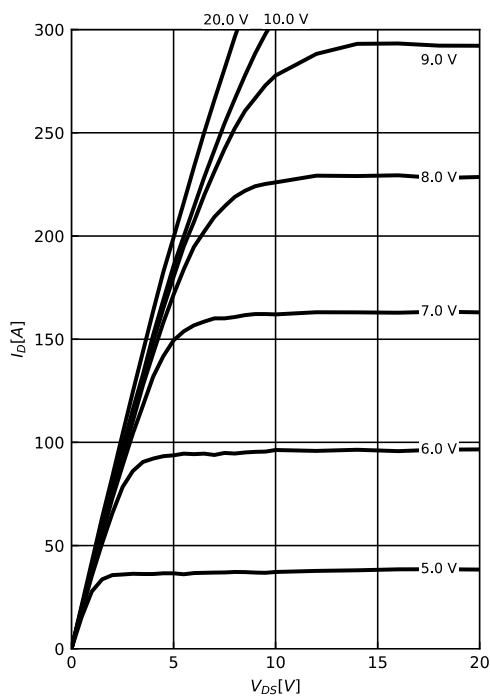

$I_D = f(V_{DS}); T_j = 25^\circ\text{C}; \text{parameter: } V_{GS}$

Diagram 4: Typ. output characteristics

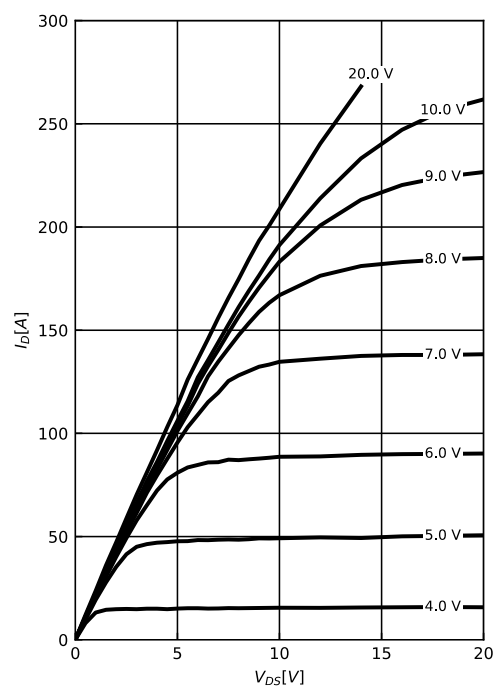

$I_D = f(V_{DS}); T_j = 150^\circ\text{C}; \text{parameter: } V_G$

Electrical characteristics diagrams

Diagram 5: Typ. drain-source on-state resistance

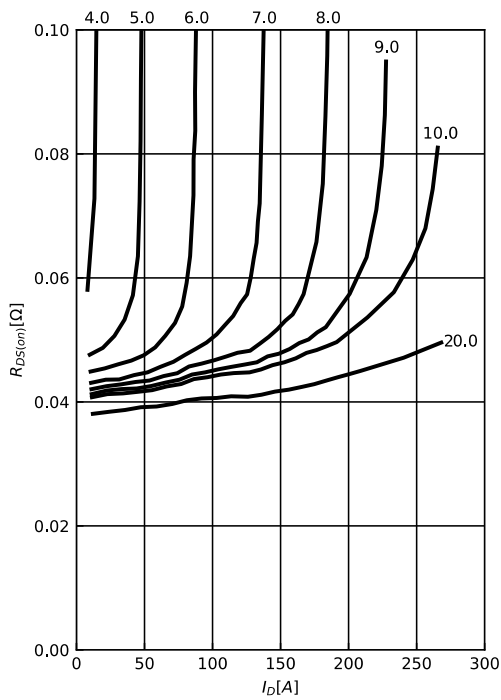

$R_{DS(on)} = f(I_D); T_j = 150\text{ }^\circ\text{C};$ parameter: V_{GS}

Diagram 6: Typ. drain-source on-state resistance

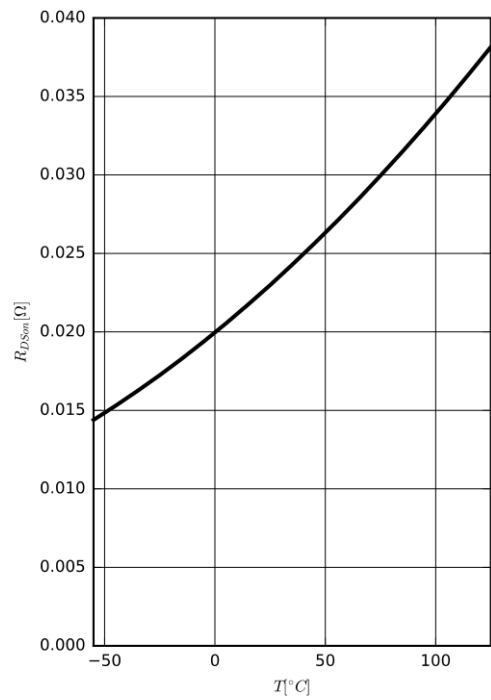

$R_{DS(on)} = f(T_j); I_D = 35\text{A}$

Diagram 7: Typ. transfer characteristics

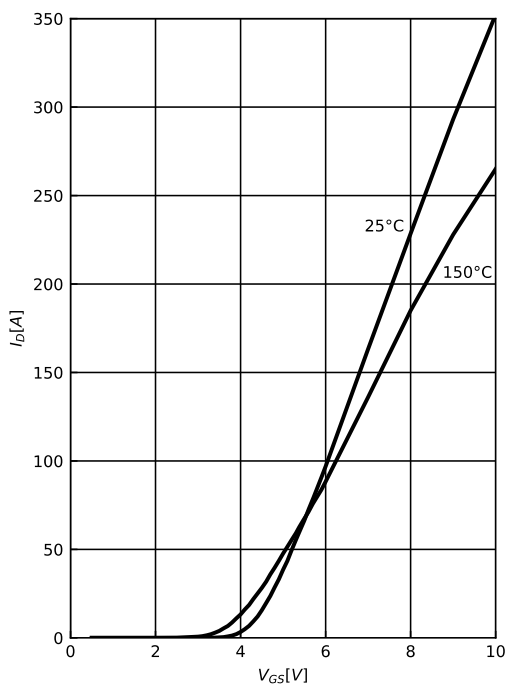

$I_D = f(V_{GS}); V_{DS} = 20\text{V};$ parameter: T_j

Diagram 8: Typ. gate threshold voltage

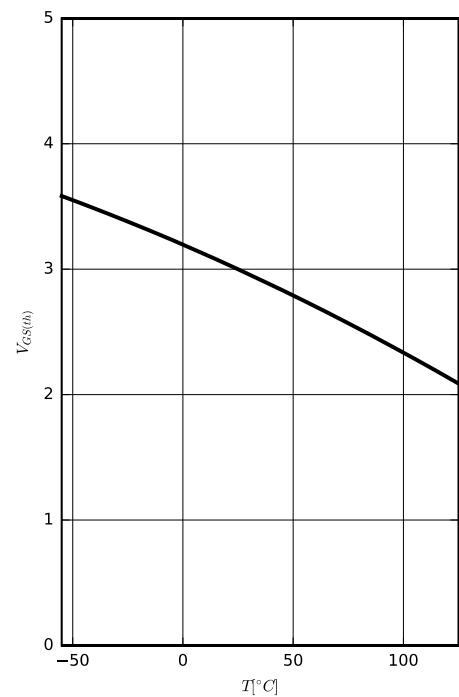

$V_{GS(th)} = f(T_j); I_D = 1\text{mA}$

Electrical characteristics diagrams

Diagram 9: Forward characteristics of reverse diode

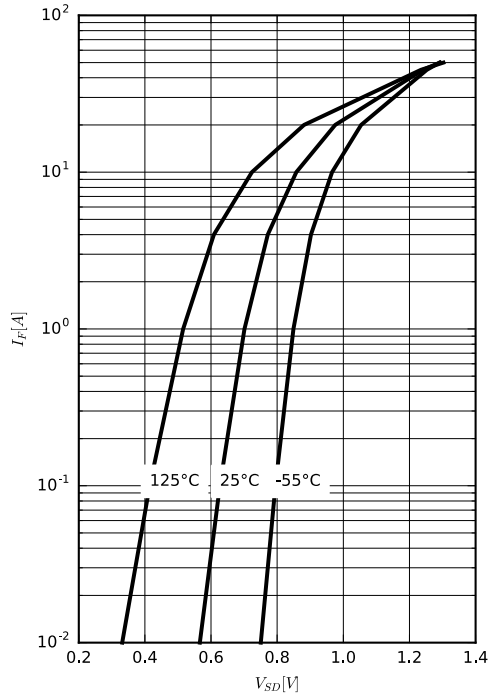

$I_F = f(V_{SD});$ parameter: T_j

Diagram 10: Drain-source breakdown voltage

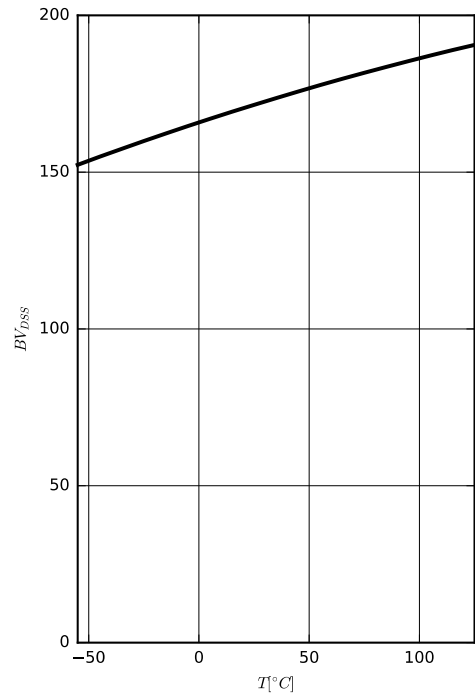

$BV_{DSS} = f(T_j); I_D = 250\mu A$

Diagram 11: Typ. capacitances

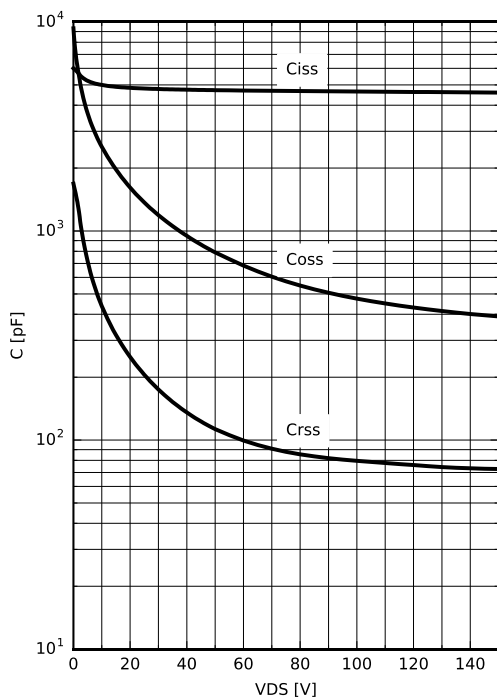

$C = f(V_{DS}); V_{GS} = 0 V; f = 1 MHz$

Diagram 12: Typ. gate charge

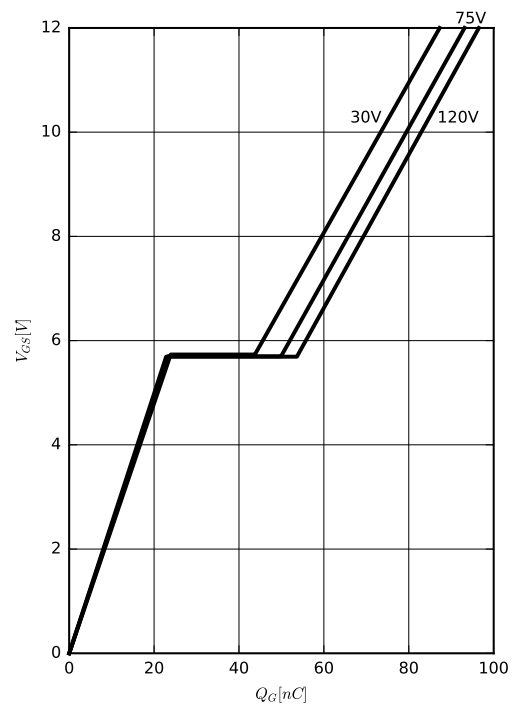

$V_{GS} = f(Q_{gate}); I_D = 45.0 A$ pulsed; parameter: V_{DD}

6 Package outlines

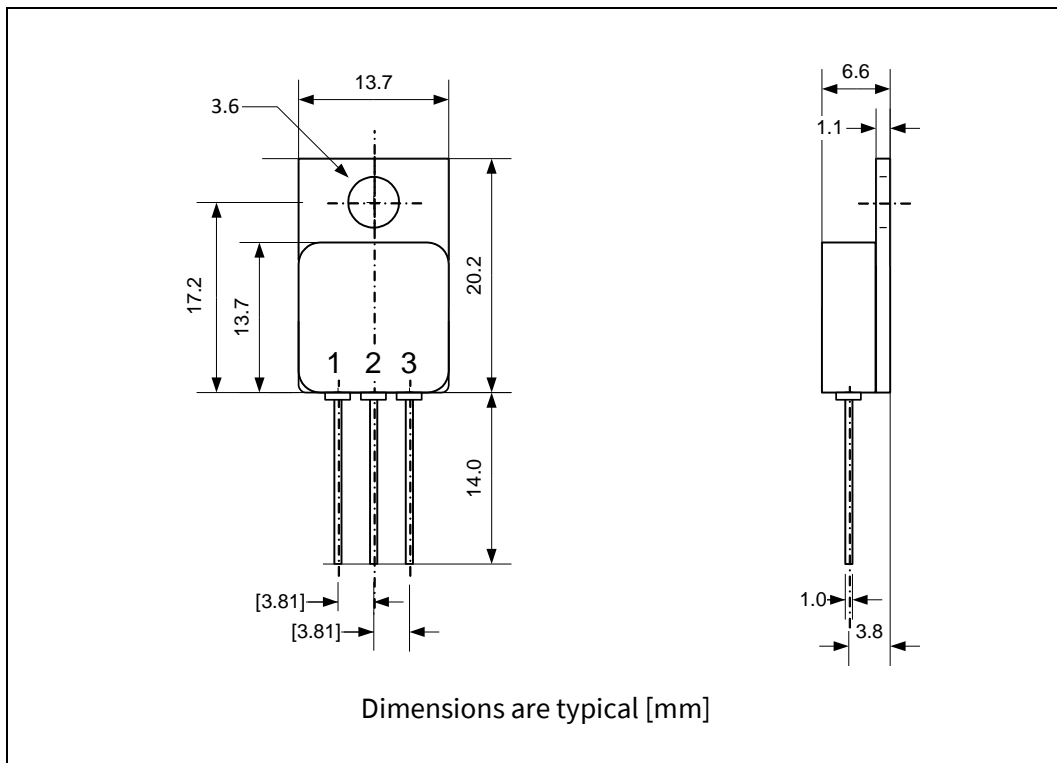

Trademarks

All referenced product or service names and trademarks are the property of their respective owners.

Edition 4, October 2020

Published by

Infineon Technologies AG

81726 München, Germany

© 2020 Infineon Technologies AG.

All Rights Reserved.

Do you have a question about this document?

Email: erratum@infineon.com

IMPORTANT NOTICE

The information given in this document shall in no event be regarded as a guarantee of conditions or characteristics ("Beschaffheitsgarantie").

With respect to any examples, hints or any typical values stated herein and/or any information regarding the application of the product, Infineon Technologies hereby disclaims any and all warranties and liabilities of any kind, including without limitation warranties of non-infringement of intellectual property rights of any third party.

In addition, any information given in this document is subject to customer's compliance with its obligations stated in this document and any applicable legal requirements, norms and standards concerning customer's products and any use of the product of Infineon Technologies in customer's applications.

The data contained in this document is exclusively intended for technically trained staff. It is the responsibility of customer's technical departments to evaluate the suitability of the product for the intended application and the completeness of the product information given in this document with respect to such application.

For further information on the product, technology, delivery terms and conditions and prices please contact your nearest Infineon Technologies office (www.infineon.com).

WARNINGS

Due to technical requirements products may contain dangerous substances. For information on the types in question please contact your nearest Infineon Technologies office.

Infineon Technologies Components may only be used in life-support devices or systems with the expressed written approval of Infineon Technologies, if a failure of such components can reasonably be expected to cause the failure of that life-support device or system, or to affect the safety or effectiveness of that device or system.

Life support devices or systems are intended to be implanted in the human body, or to support and/or maintain and sustain and/or protect human life. If they fail, it is reasonable to assume that the health of the user or other persons may be endangered.