



# DATA SHEET

SEMICONDUCTOR

BZX55C/B Series

## 500 mW DO-35 Hermetically Sealed Glass Zener Voltage Regulators



### Absolute Maximum Ratings $T_A = 25^\circ\text{C}$ unless otherwise noted

Parameter	Value	Units
Power Dissipation	500	mW
Storage Temperature Range	-65 to +175	$^\circ\text{C}$
Operating Junction Temperature	+175	$^\circ\text{C}$

These ratings are limiting values above which the serviceability of the diode may be impaired.

### Specification Features:

- Zener Voltage Range 2.0 to 75 Volts
- DO-35 Package (JEDEC)
- Through-Hole Device Type Mounting
- Hermetically Sealed Glass
- Compression Bonded Construction
- All External Surfaces Are Corrosion Resistant And Leads Are Readily Solderable
- RoHS Compliant
- Solder Hot Dip Tin (Sn) Terminal Finish
- Cathode Indicated By Polarity Band



AXIAL LEAD DO35

DEVICE MARKING DIAGRAM

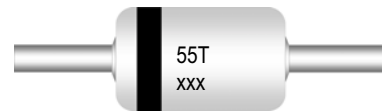

Device Code : BZX55Txxx  
T : VZ tolerance B or C

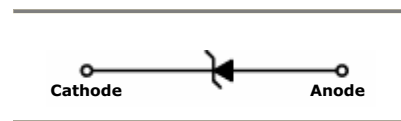

ELECTRICAL SYMBOL

### Electrical Characteristics $T_A = 25^\circ\text{C}$ unless otherwise noted

Device Type	$V_Z @ I_{ZT}$ (Volts)		$I_{ZT}$ (mA)	$Z_{ZT} @ I_{ZT}$ ( $\Omega$ ) Max	$I_{ZK}$ (mA)	$Z_{ZK} @ I_{ZK}$ ( $\Omega$ ) Max	$I_R @ V_R$ ( $\mu\text{A}$ ) Max	$V_R$ (Volts)
	Min	Max						
BZX55C 2V0	1.88	2.11	5	100	1	600	100	1
BZX55C 2V2	2.08	2.33	5	100	1	600	100	1
BZX55C 2V4	2.28	2.56	5	85	1	600	50	1
BZX55C 2V7	2.51	2.89	5	85	1	600	10	1
BZX55C 3V0	2.8	3.2	5	85	1	600	4	1
BZX55C 3V3	3.1	3.5	5	85	1	600	2	1
BZX55C 3V6	3.4	3.8	5	85	1	600	2	1
BZX55C 3V9	3.7	4.1	5	85	1	600	2	1
BZX55C 4V3	4.0	4.6	5	75	1	600	1	1
BZX55C 4V7	4.4	5.0	5	60	1	600	0.5	1
BZX55C 5V1	4.8	5.4	5	35	1	550	0.1	1
BZX55C 5V6	5.2	6.0	5	25	1	450	0.1	1
BZX55C 6V2	5.8	6.6	5	10	1	200	0.1	2
BZX55C 6V8	6.4	7.2	5	8	1	150	0.1	3
BZX55C 7V5	7.0	7.9	5	7	1	50	0.1	5
BZX55C 8V2	7.7	8.7	5	7	1	50	0.1	6.2
BZX55C 9V1	8.5	9.6	5	10	1	50	0.1	6.8
BZX55C 10	9.4	10.6	5	15	1	70	0.1	7.5
BZX55C 11	10.4	11.6	5	20	1	70	0.1	8.2
BZX55C 12	11.4	12.7	5	20	1	90	0.1	9.1
BZX55C 13	12.4	14.1	5	26	1	110	0.1	10

# BZX55C/B Series

## Electrical Characteristics

T<sub>A</sub> = 25°C unless otherwise noted

Device Type	V <sub>Z</sub> @ I <sub>ZT</sub> (Volts)		I <sub>ZT</sub> (mA)	Z <sub>ZT</sub> @ I <sub>ZT</sub> (Ω) Max	I <sub>ZK</sub> (mA)	Z <sub>ZK</sub> @ I <sub>ZK</sub> (Ω) Max	I <sub>R</sub> @ V <sub>R</sub> (μA) Max	V <sub>R</sub> (Volts)
	Min	Max						
BZX55C 15	13.8	15.6	5	30	1	110	0.1	11
BZX55C 16	15.3	17.1	5	40	1	170	0.1	12
BZX55C 18	16.8	19.1	5	50	1	170	0.1	13
BZX55C 20	18.8	21.1	5	55	1	220	0.1	15
BZX55C 22	20.8	23.3	5	55	1	220	0.1	16
BZX55C 24	22.8	25.6	5	80	1	220	0.1	18
BZX55C 27	25.1	28.9	5	80	1	220	0.1	20
BZX55C 30	28	32	5	80	1	220	0.1	22
BZX55C 33	31	35	5	80	1	220	0.1	24
BZX55C 36	34	38	5	80	1	220	0.1	27
BZX55C 39	37	41	2.5	90	0.5	500	0.1	28
BZX55C 43	40	46	2.5	90	0.5	600	0.1	32
BZX55C 47	44	50	2.5	110	0.5	700	0.1	35
BZX55C 51	48	54	2.5	125	0.5	700	0.1	38
BZX55C 56	52	60	2.5	135	0.5	1000	0.1	42
BZX55C 62	58	66	2.5	150	0.5	1000	0.1	47
BZX55C 68	64	72	2.5	160	0.5	1000	0.1	51
BZX55C 75	70	80	2.5	170	0.5	1000	0.1	56

V<sub>F</sub> Forward Voltage = 1.0 V Maximum @ I<sub>F</sub> = 100 mA for all types

Device Type	V <sub>Z</sub> @ I <sub>ZT</sub> (Volts)		I <sub>ZT</sub> (mA)	Z <sub>ZT</sub> @ I <sub>ZT</sub> (Ω) Max	I <sub>ZK</sub> (mA)	Z <sub>ZK</sub> @ I <sub>ZK</sub> (Ω) Max	I <sub>R</sub> @ V <sub>R</sub> (μA) Max	V <sub>R</sub> (Volts)
	Min	Max						
BZX55B 2V4	2.35	2.45	5	85	1	600	50	1
BZX55B 2V7	2.65	2.75	5	85	1	600	10	1
BZX55B 3V0	2.94	3.06	5	85	1	600	4	1
BZX55B 3V3	3.23	3.37	5	85	1	600	2	1
BZX55B 3V6	3.53	3.67	5	85	1	600	2	1
BZX55B 3V9	3.82	3.98	5	85	1	600	2	1
BZX55B 4V3	4.21	4.39	5	75	1	600	1	1
BZX55B 4V7	4.61	4.79	5	60	1	600	0.5	1
BZX55B 5V1	5.00	5.20	5	35	1	550	0.1	1
BZX55B 5V6	5.49	5.71	5	25	1	450	0.1	1
BZX55B 6V2	6.08	6.32	5	10	1	200	0.1	2
BZX55B 6V8	6.66	6.94	5	8	1	150	0.1	3
BZX55B 7V5	7.33	7.63	5	7	1	50	0.1	5
BZX55B 8V2	8.04	8.36	5	7	1	50	0.1	6.2
BZX55B 9V1	8.92	9.28	5	10	1	50	0.1	6.8
BZX55B 10	9.80	10.20	5	15	1	70	0.1	7.5
BZX55B 11	10.78	11.22	5	20	1	70	0.1	8.2
BZX55B 12	11.76	12.24	5	20	1	90	0.1	9.1
BZX55B 13	12.74	13.26	5	26	1	110	0.1	10
BZX55B 15	14.70	15.30	5	30	1	110	0.1	11
BZX55B 16	15.68	16.32	5	40	1	170	0.1	12
BZX55B 18	17.64	18.36	5	50	1	170	0.1	13
BZX55B 20	19.60	20.40	5	55	1	220	0.1	15
BZX55B 22	21.56	22.44	5	55	1	220	0.1	16
BZX55B 24	23.52	24.48	5	80	1	220	0.1	18
BZX55B 27	26.46	27.54	5	80	1	220	0.1	20
BZX55B 30	29.40	30.60	5	80	1	220	0.1	22
BZX55B 33	32.34	33.66	5	80	1	220	0.1	24
BZX55B 36	35.28	36.72	5	80	1	220	0.1	27
BZX55B 39	38.22	39.78	2.5	90	0.5	500	0.1	28
BZX55B 43	42.14	43.86	2.5	90	0.5	600	0.1	32
BZX55B 47	46.06	47.94	2.5	110	0.5	700	0.1	35

## BZX55C/B Series

### Electrical Characteristics $T_A = 25^\circ\text{C}$ unless otherwise noted

Device Type	$V_Z @ I_{ZT}$ (Volts)		$I_{ZT}$ (mA)	$Z_{ZT} @ I_{ZT}$ ( $\Omega$ ) Max	$I_{ZK}$ (mA)	$Z_{ZK} @ I_{ZK}$ ( $\Omega$ ) Max	$I_R @ V_R$ ( $\mu\text{A}$ ) Max	$V_R$ (Volts)
	Min	Max						
BZX55B 51	49.98	52.02	2.5	125	0.5	700	0.1	38
BZX55B 56	54.88	57.12	2.5	135	0.5	1000	0.1	42
BZX55B 62	60.76	63.24	2.5	150	0.5	1000	0.1	47
BZX55B 68	66.64	69.36	2.5	160	0.5	1000	0.1	51
BZX55B 75	73.50	76.50	2.5	170	0.5	1000	0.1	56

$V_F$  Forward Voltage = 1.0 V Maximum @  $I_F = 100$  mA for all types

#### Notes:

##### 1. TOLERANCE AND VOLTAGE DESIGNATION

The type numbers listed have zener voltage as shown.

##### 2. SPECIALS AVAILABLE INCLUDE

Nominal zener voltages between the voltages shown and tighter voltage, for detailed information on price, availability and delivery, contact you nearest Tak Cheong representative.

##### 3. ZENER VOLTAGE ( $V_Z$ ) MEASUREMENT

The zener voltage is measured under pulse conditions such that  $T_j$  is no more than  $2^\circ\text{C}$  above  $T_A$ .

##### 4. ZENER IMPEDANCE ( $Z_Z$ ) DERIVATION

Zener impedance is derived from the 60-cycle ac voltage, which results when an ac current having an RMS value equal to 10% of the dc zener current ( $I_{ZT}$ ) is superimposed to  $I_{ZT}$ .

# DEVICE CHARACTERISTICS

## BZX55C/B Series

### Typical Characteristics

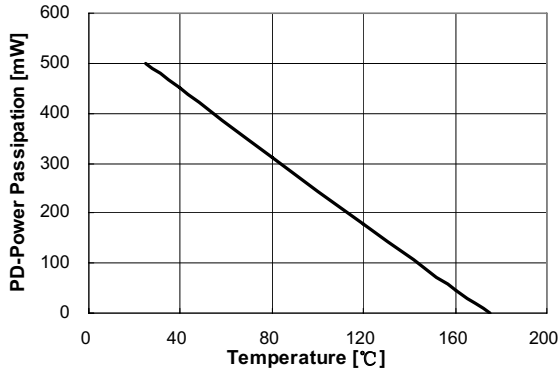

**Figure 1. Power Dissipation vs Ambient Temperature**  
Valid provided leads at a distance of 0.8mm from case are kept at ambient temperature

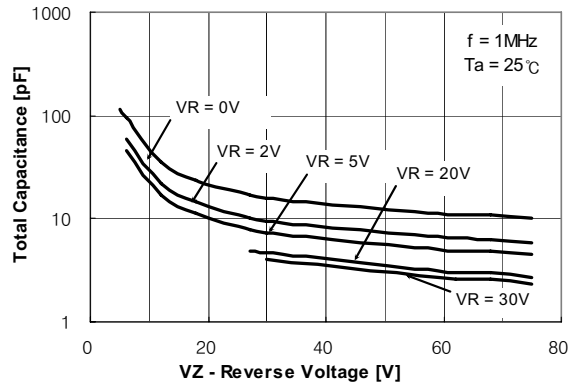

**Figure 2. Total Capacitance**

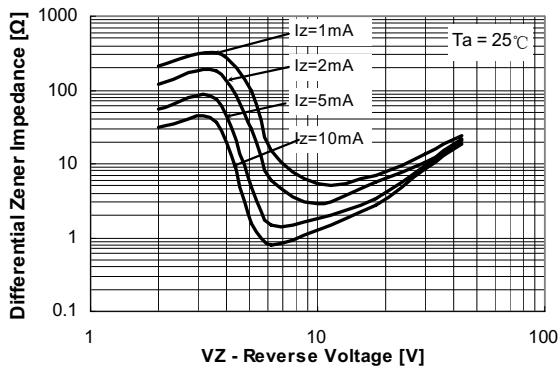

**Figure 3. Differential Impedance vs. Zener Voltage**

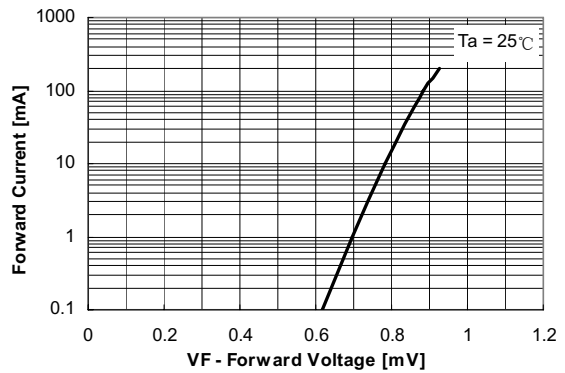

**Figure 4. Forward Current vs. Forward Voltage**

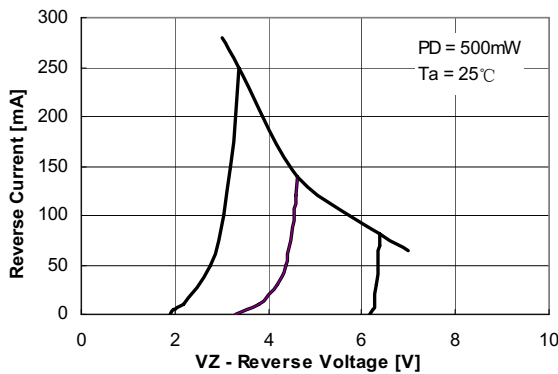

**Figure 5. Reverse Current vs. Reverse Voltage**

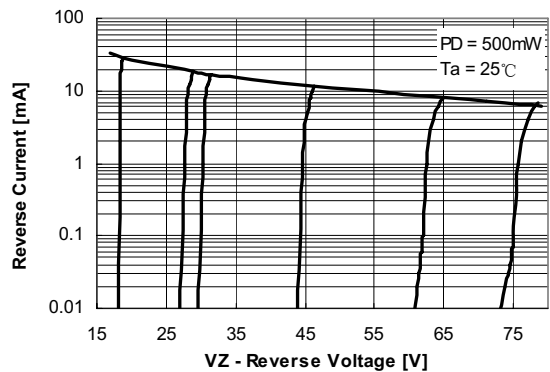
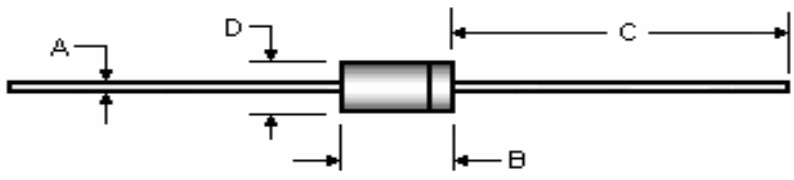

**Figure 6. Reverse Current vs. Reverse Voltage**

# PACKAGE OUTLINE & DIMENSIONS

## BZX55C/B Series

### Package Outline

Package	Case Outline				
DO-35					
	DO-35				
	DIM	Millimeters		Inches	
		Min	Max	Min	Max
	A	0.46	0.55	0.018	0.022
	B	3.05	5.08	0.120	0.200
C	25.40	38.10	1.000	1.500	
D	1.53	2.28	0.060	0.090	

**Notes:**

1. All dimensions are within JEDEC standard.
2. DO35 polarity denoted by cathode band.