

# $\mu$ PC251 / 1458

## General Purpose Dual Operational Amplifiers

### GENERAL DESCRIPTION

The  $\mu$ PC251 and 1458 are dual general purpose operational amplifiers having internal frequency compensating circuits. It is intended for a wide range of analog applications. High common mode voltage range and no latch up tendencies make this amplifier ideal for use as a voltage follower.

Two kinds of ICs are available according to reliability, the  $\mu$ PC251 for industry, the  $\mu$ PC1458 for commercial.

### FEATURES

- Dual  $\mu$ PC151/741 Internally Frequency Compensated Operational Amplifier
- Short Circuit Protection
- Large Common Mode and Differential Input Voltage
- No Latch Up
- MC1458 Direct Replacement

### EQUIVALENT CIRCUIT

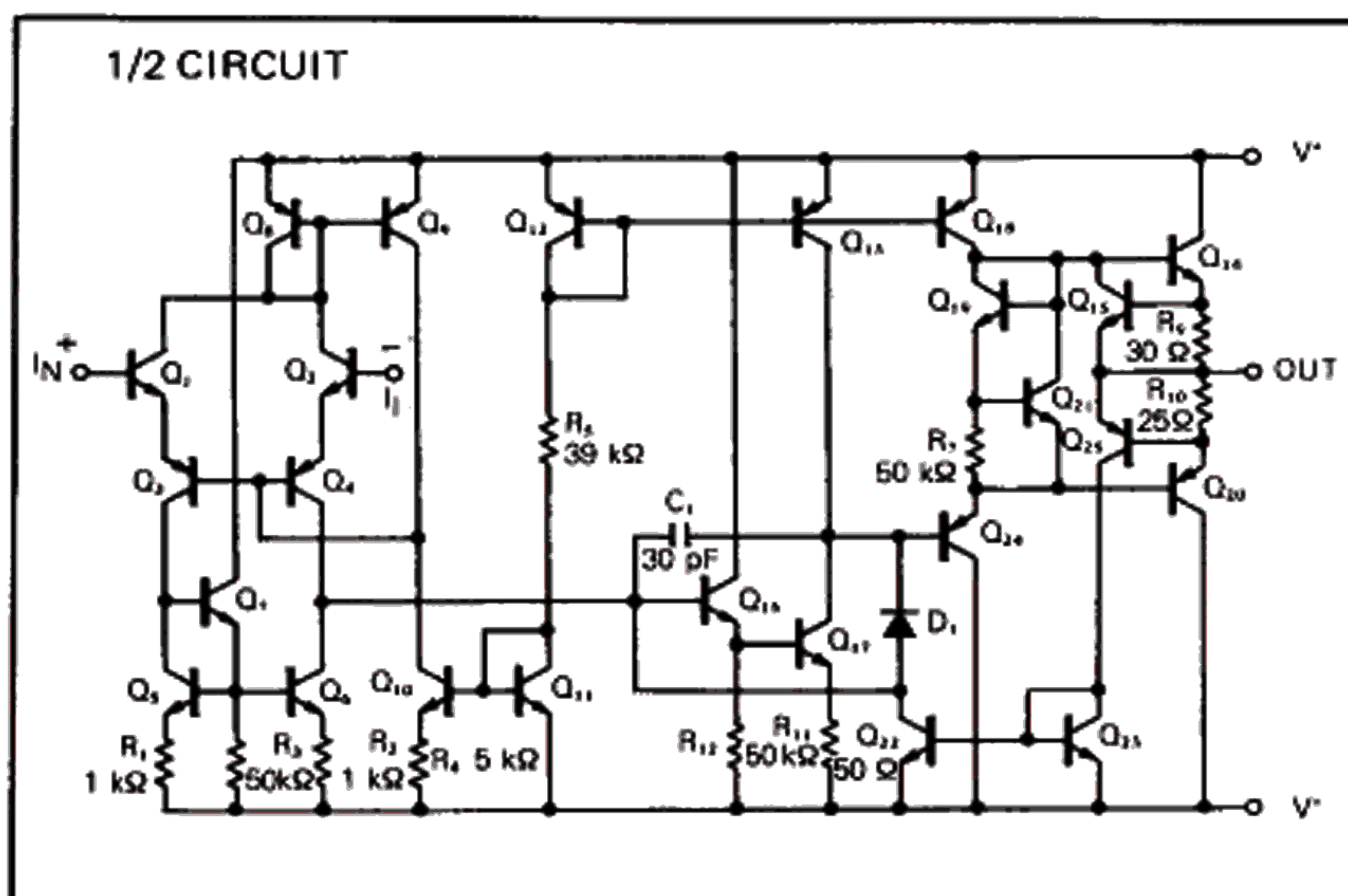

### ORDERING INFORMATION

$\mu$ PC251D



8 pin Ceramic DIP  
(Dual In-Line Package)

$\mu$ PC251C/ $\mu$ PC1458C



8 pin Plastic Molded DIP  
(Dual In-Line Package)

$\mu$ PC251G/ $\mu$ PC1458G



8 pin Plastic Molded Flat  
Package (MINI FLAT IC)

### CONNECTION DIAGRAM (Top View)

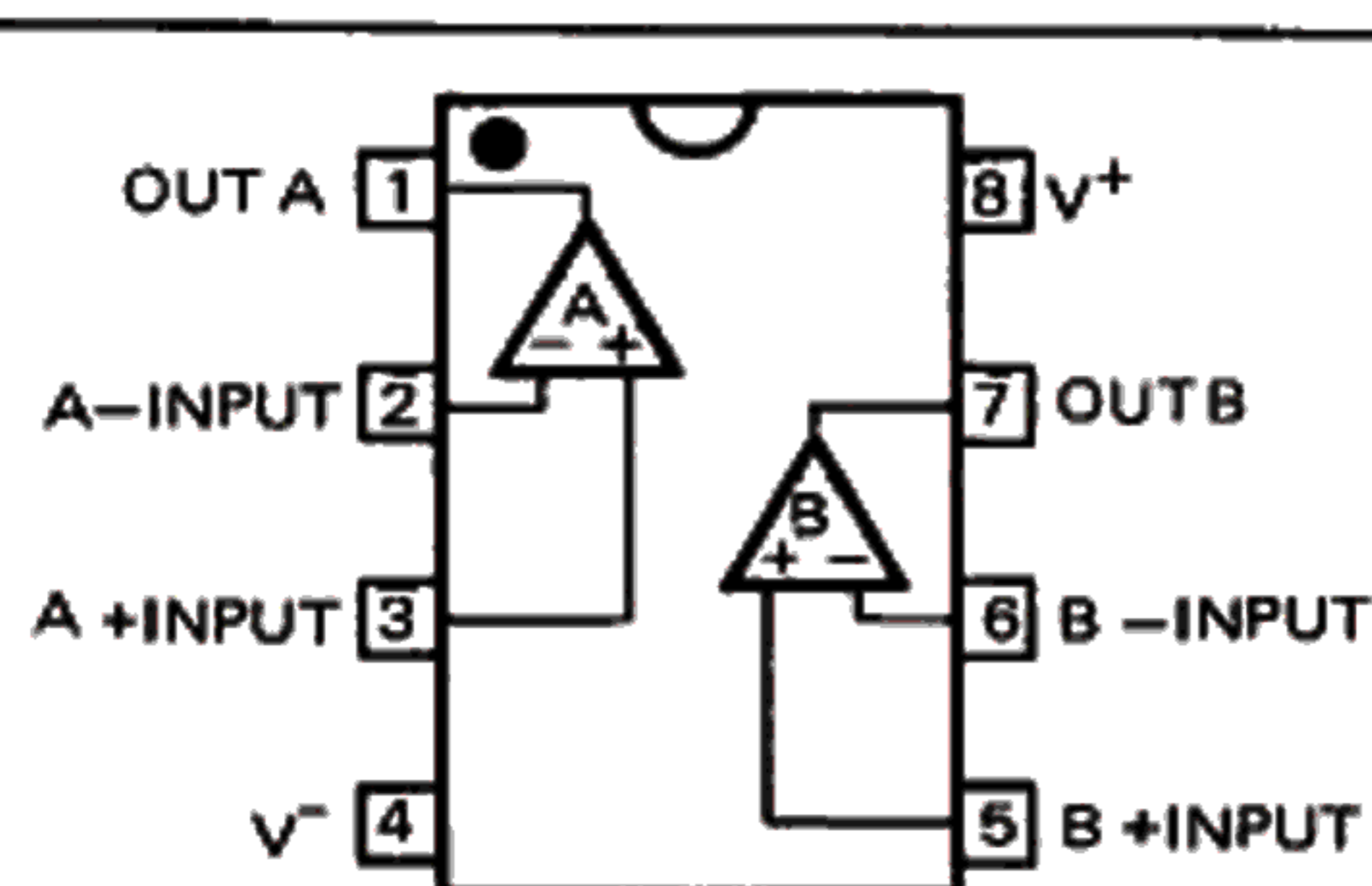

$\mu$ PC251D  
 $\mu$ PC251C/ $\mu$ PC251G  
 $\mu$ PC1458C/ $\mu$ PC1458G

**ABSOLUTE MAXIMUM RATINGS (Ta = 25°C)**

PARAMETER		$\mu$ PC251	$\mu$ PC1458	UNIT
Voltage between V <sup>+</sup> and V <sup>-</sup>		36	36	V
Power Dissipation*	D Package	500	—	mW
	C Package	350	350	
	G Package	440	440	
Differential Input Voltage		±30	±30	V
Input Voltage (Note 1)		±15	±15	V
Output Short Circuit Duration		Indefinite	Indefinite	s
Operating Temperature Range	D Package	-20 to +80	—	°C
	C or G Package	-20 to +70	0 to +70	
Storage Temperature Range	D Package	-55 to +150	—	°C
	C or G Package	-55 to +125	-55 to +125	

Note 1: For supply voltages less than ±15 V, the absolute maximum input voltage is equal to the supply voltage.

\* See thermal information in chapter 11.

**ELECTRICAL CHARACTERISTICS (V<sup>±</sup> = ±15 V, Ta = 25°C)**

CHARACTERISTIC	MIN.	TYP.	MAX.	UNIT	CONDITIONS
Input Offset Voltage		1.0	6.0	mV	R <sub>s</sub> ≤ 10 kΩ
Average Input Offset Voltage Drift		3		μV/°C	R <sub>s</sub> ≤ 10 kΩ
Input Offset Current		20	200	nA	
Input Bias Current		80	500	nA	
Large Signal Voltage Gain	20,000	160,000			R <sub>L</sub> ≥ 2 kΩ, V <sub>o</sub> = ±10 V
Channel Separation		120		dB	f = 10 Hz, R <sub>L</sub> = 2 kΩ
Supply Current		3.0	5.6	mA	
Power Consumption		90	170	mW	
Common Mode Rejection Ratio	70	90		dB	R <sub>s</sub> ≤ 10 kΩ
Supply Voltage Rejection Ratio		30	150	μV/V	R <sub>s</sub> ≤ 10 kΩ
Output Voltage Swing	±12	±14		V	R <sub>L</sub> ≥ 10 kΩ
Output Voltage Swing	±10	±13		V	R <sub>L</sub> ≥ 2 kΩ
Input Impedance	0.3	1.0		MΩ	

TYPICAL PERFORMANCE CHARACTERISTICS ( $T_a=25^\circ\text{C}$ )

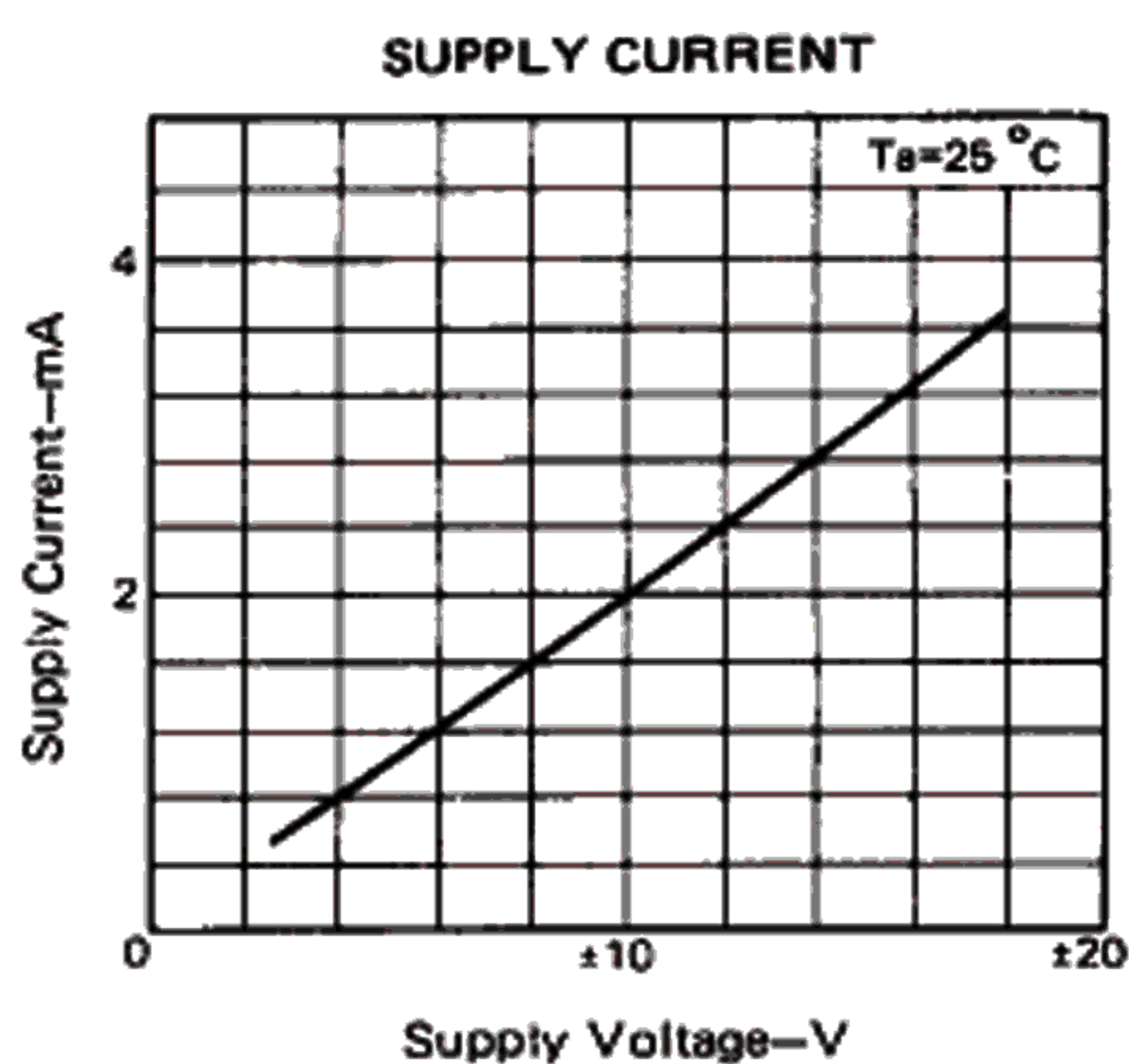
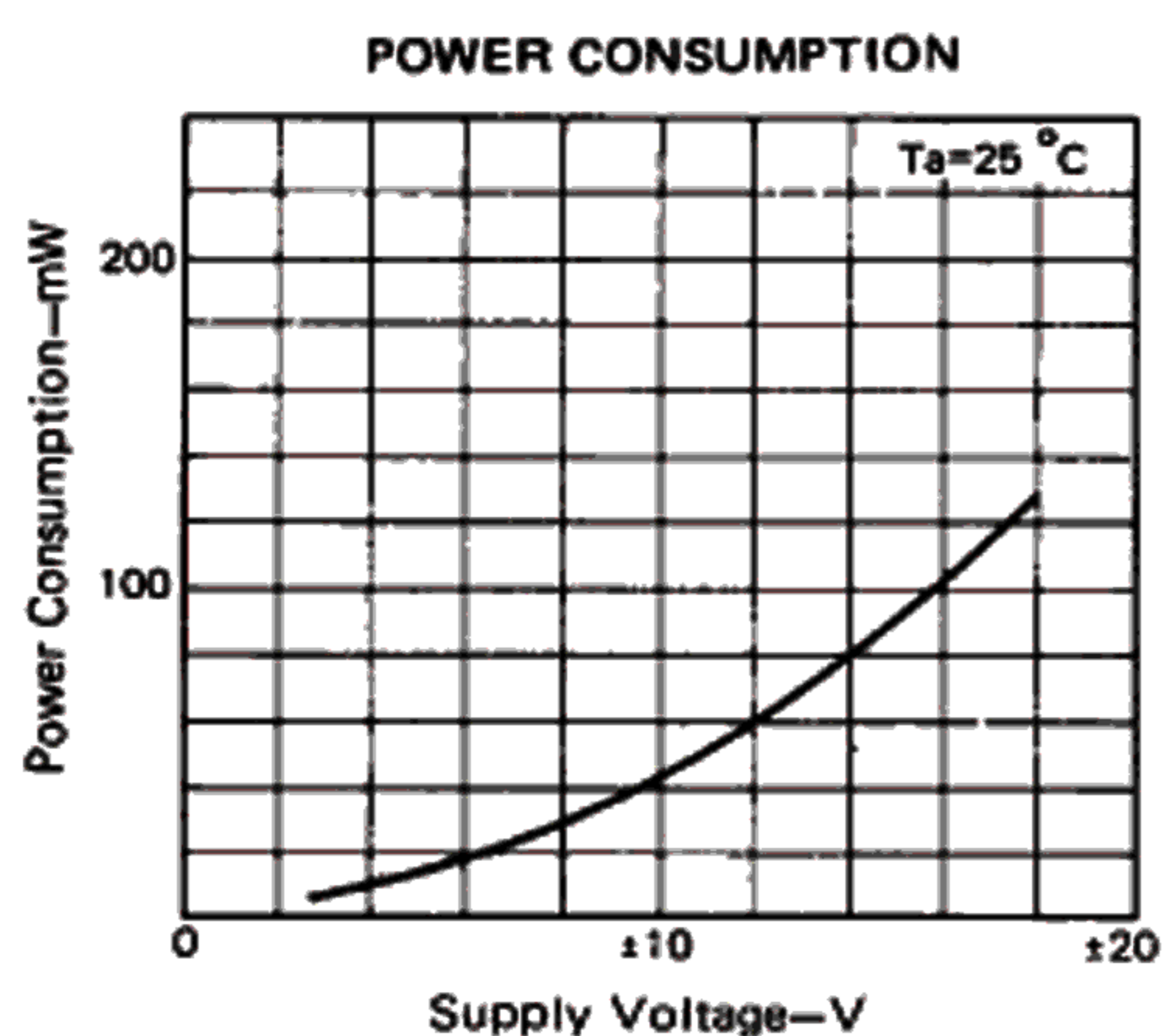
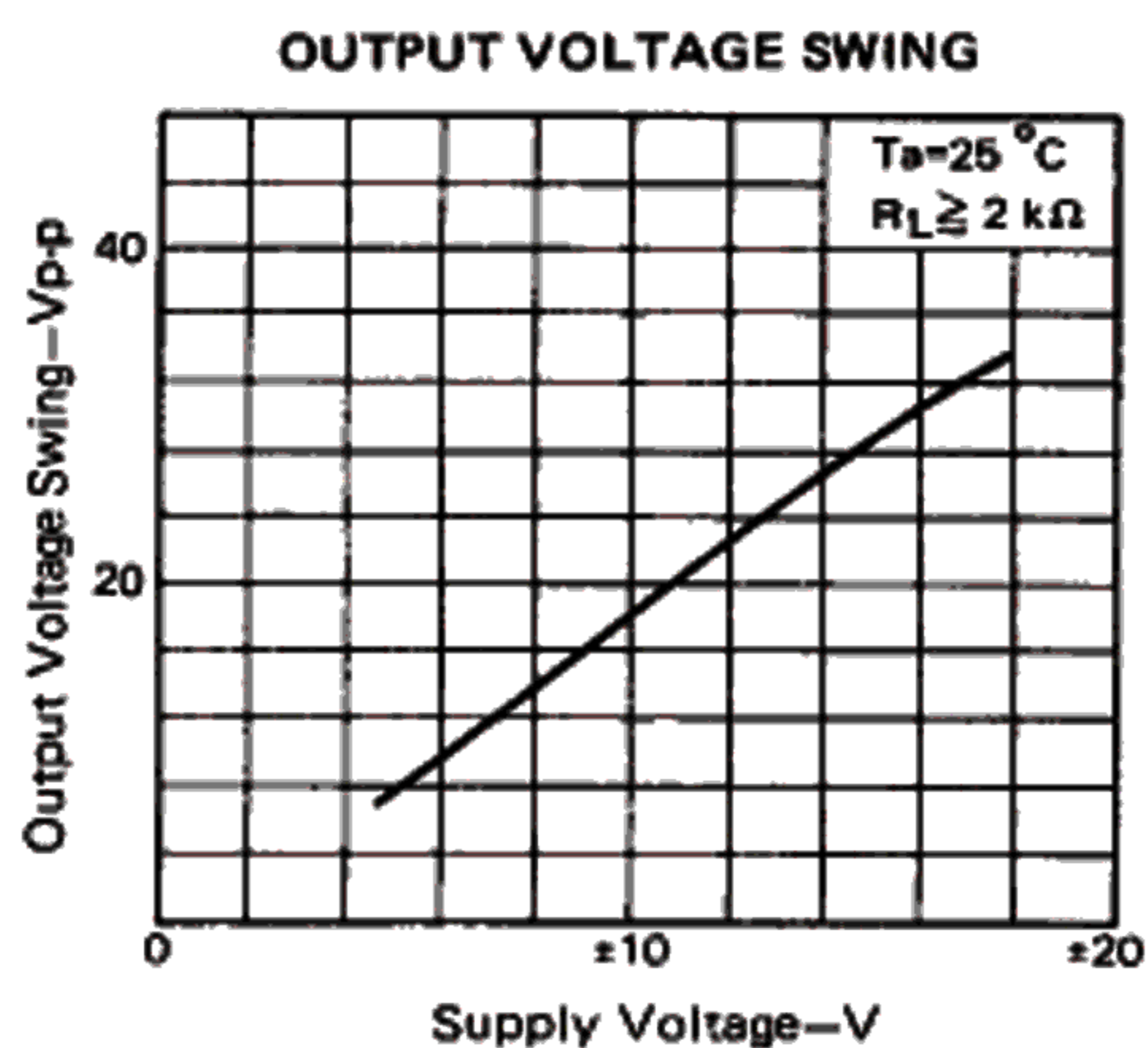
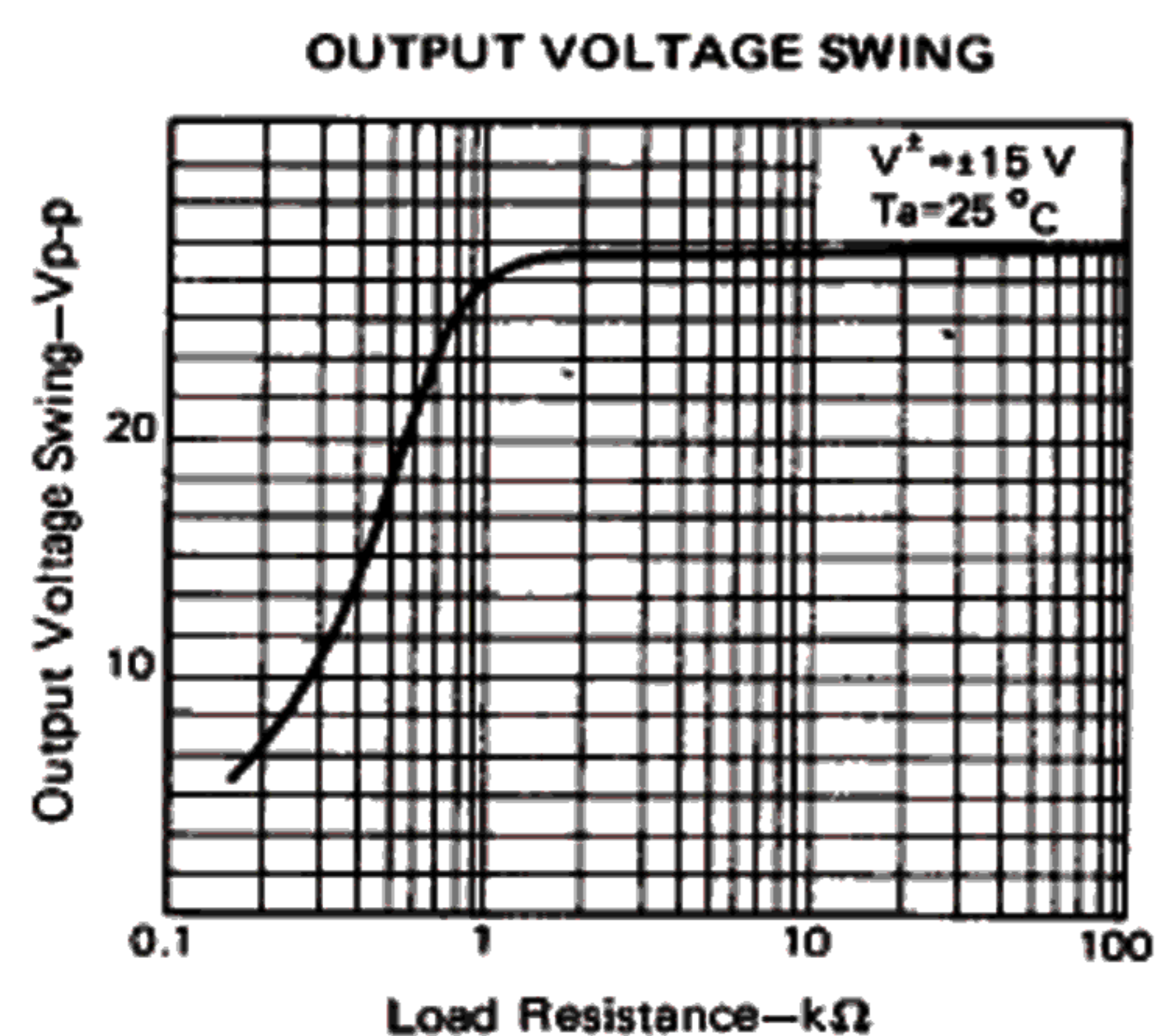
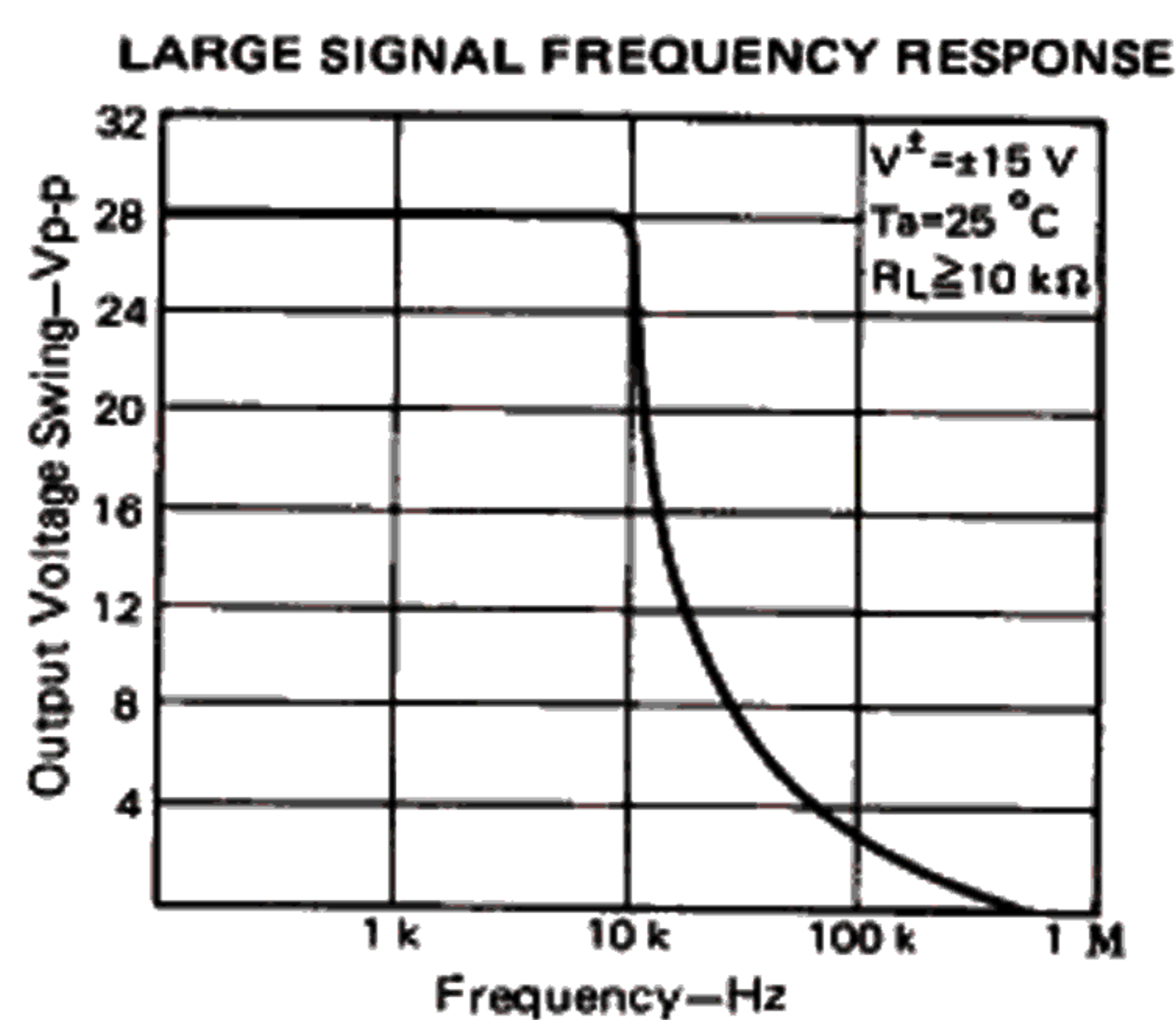
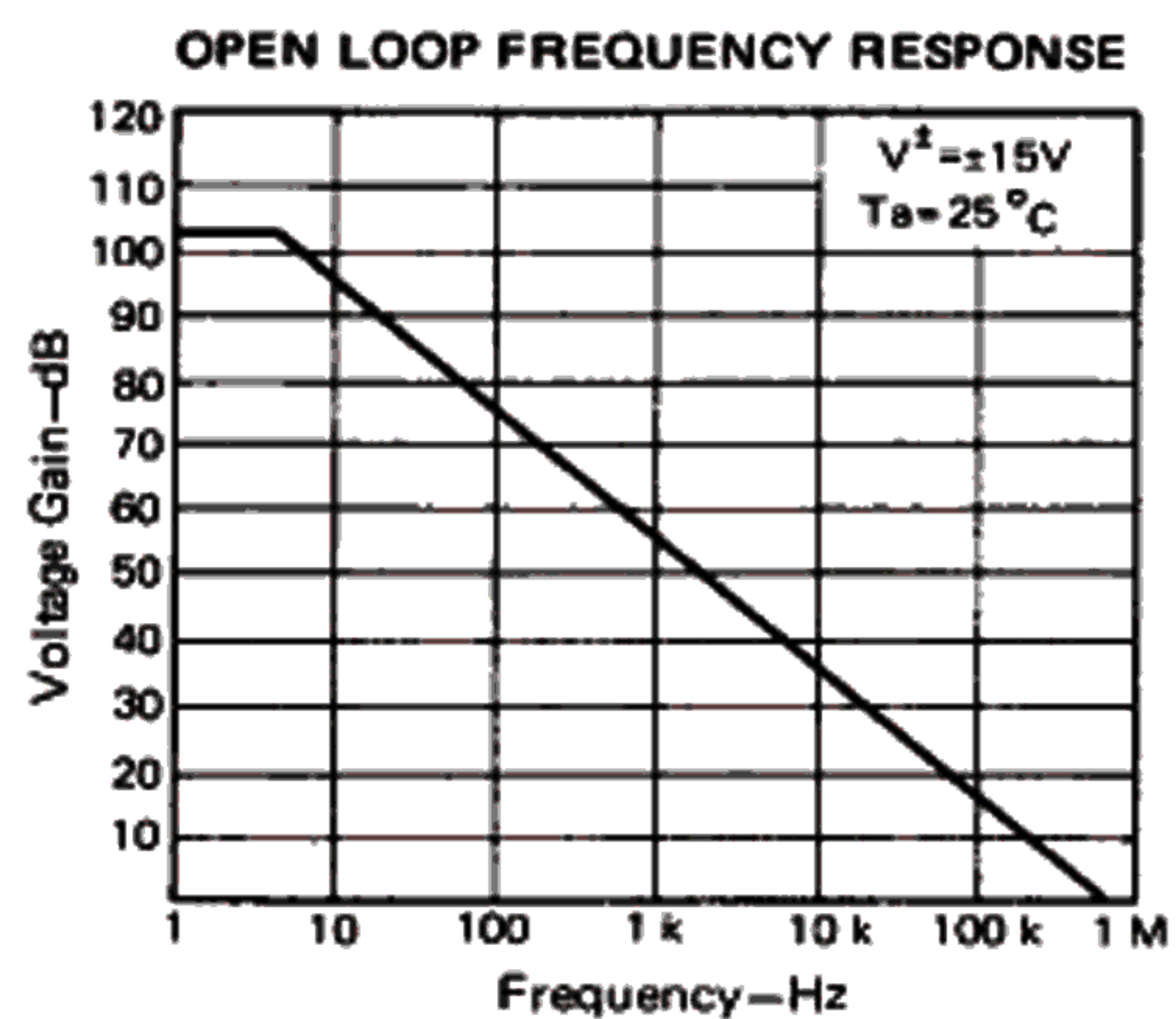

T<sub>CC</sub> - T<sub>a</sub> CHARACTERISTICS

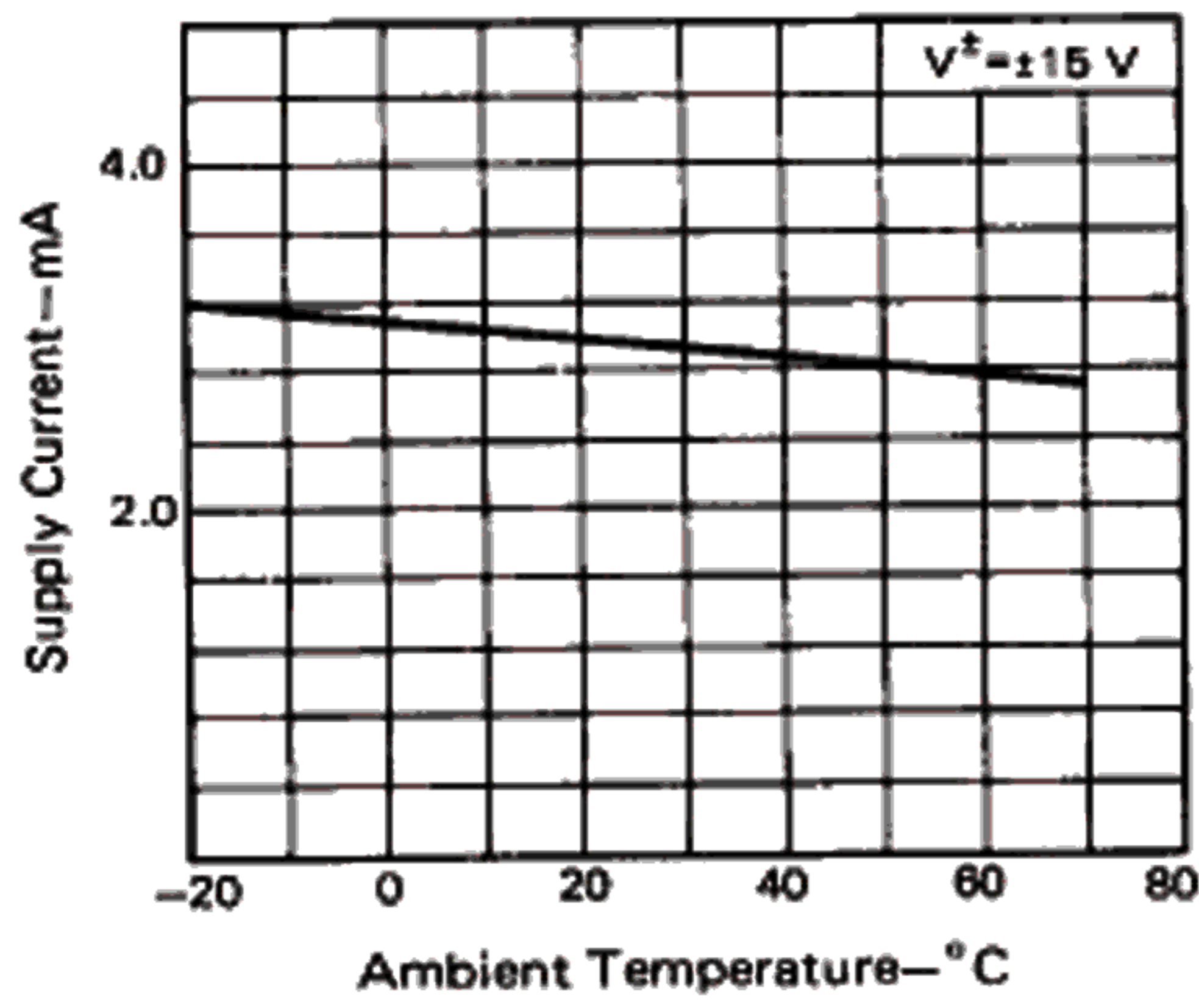

OUTPUT SHORT CIRCUIT CURRENT

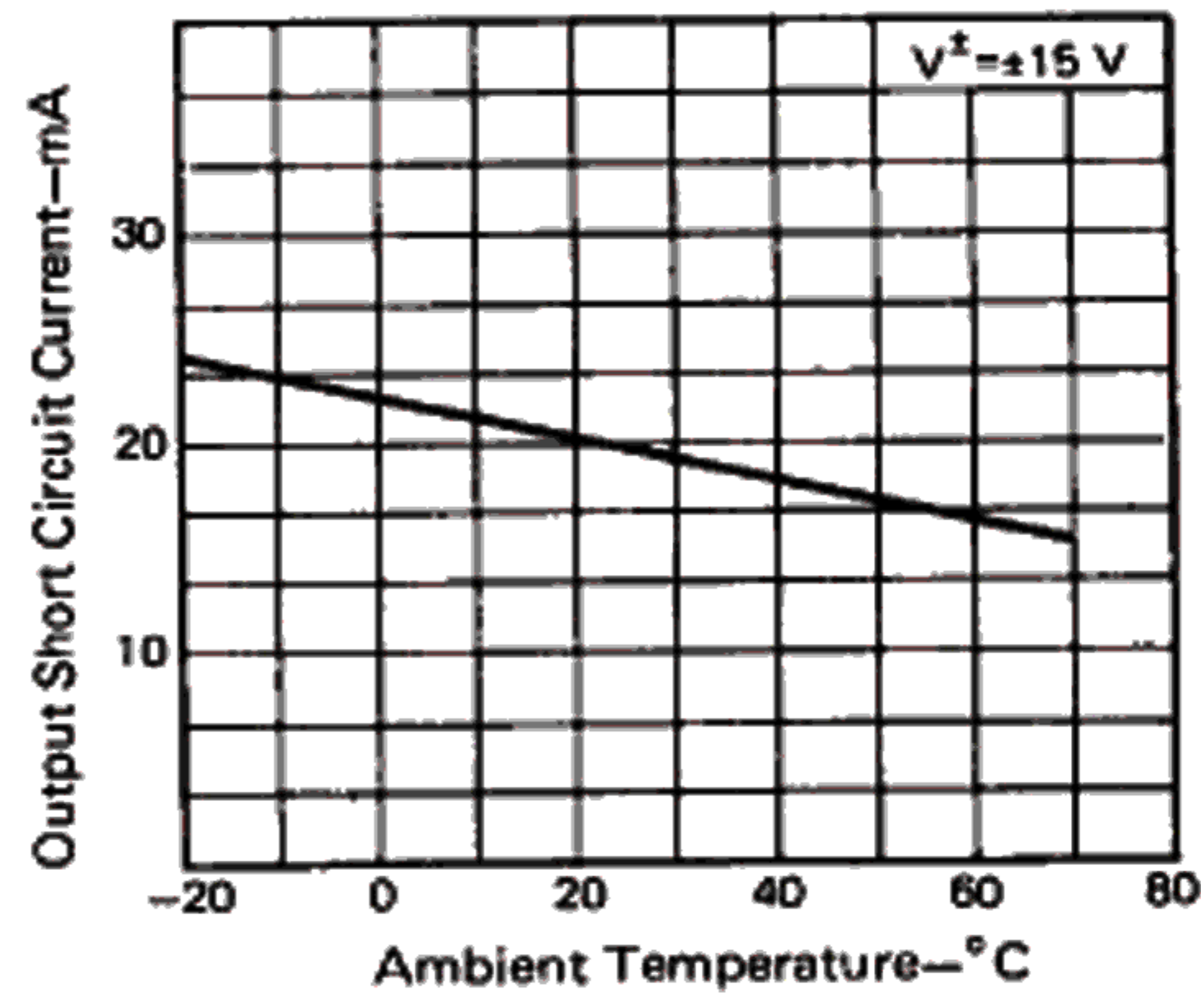

POWER CONSUMPTION

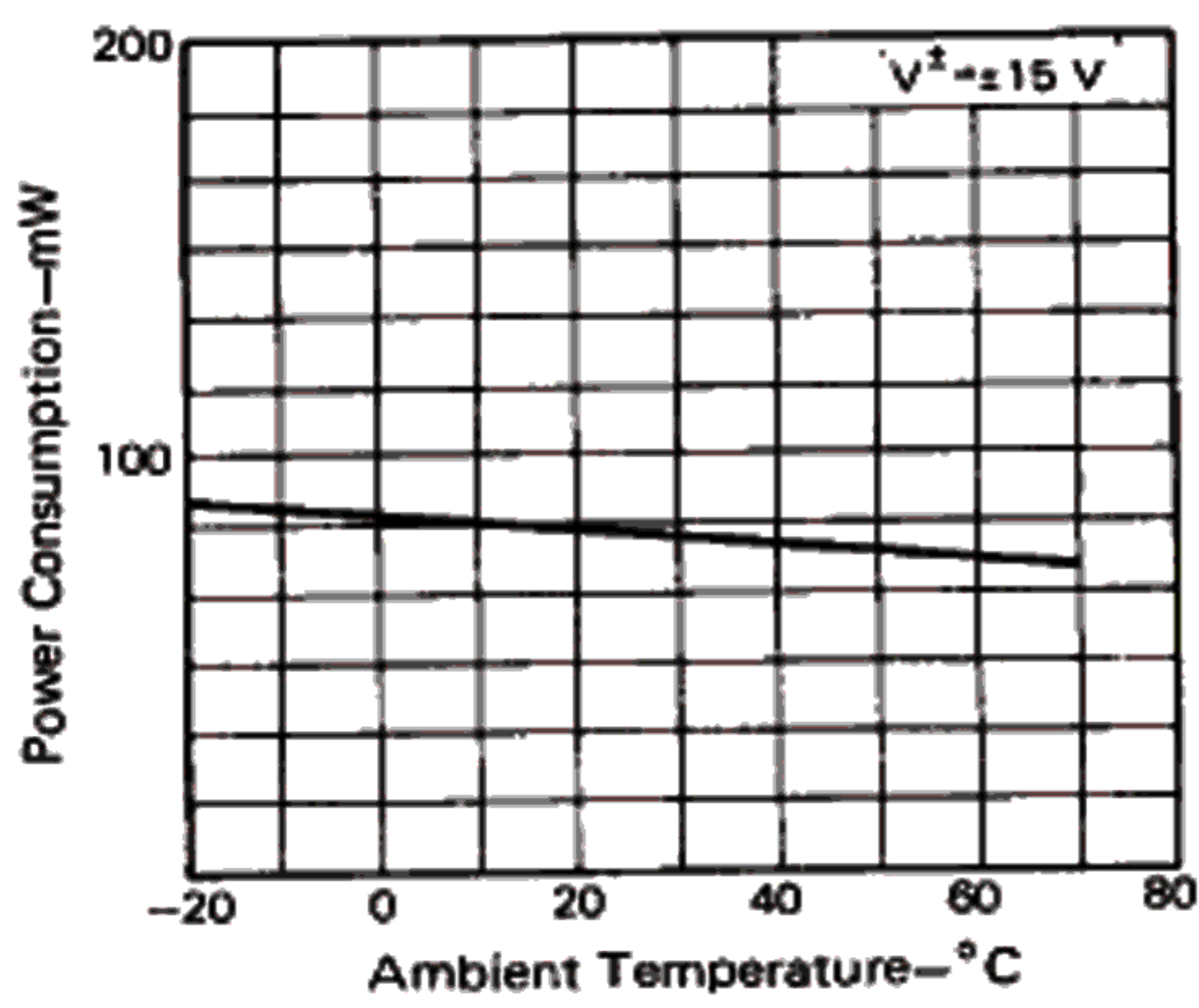

INPUT BIAS CURRENT

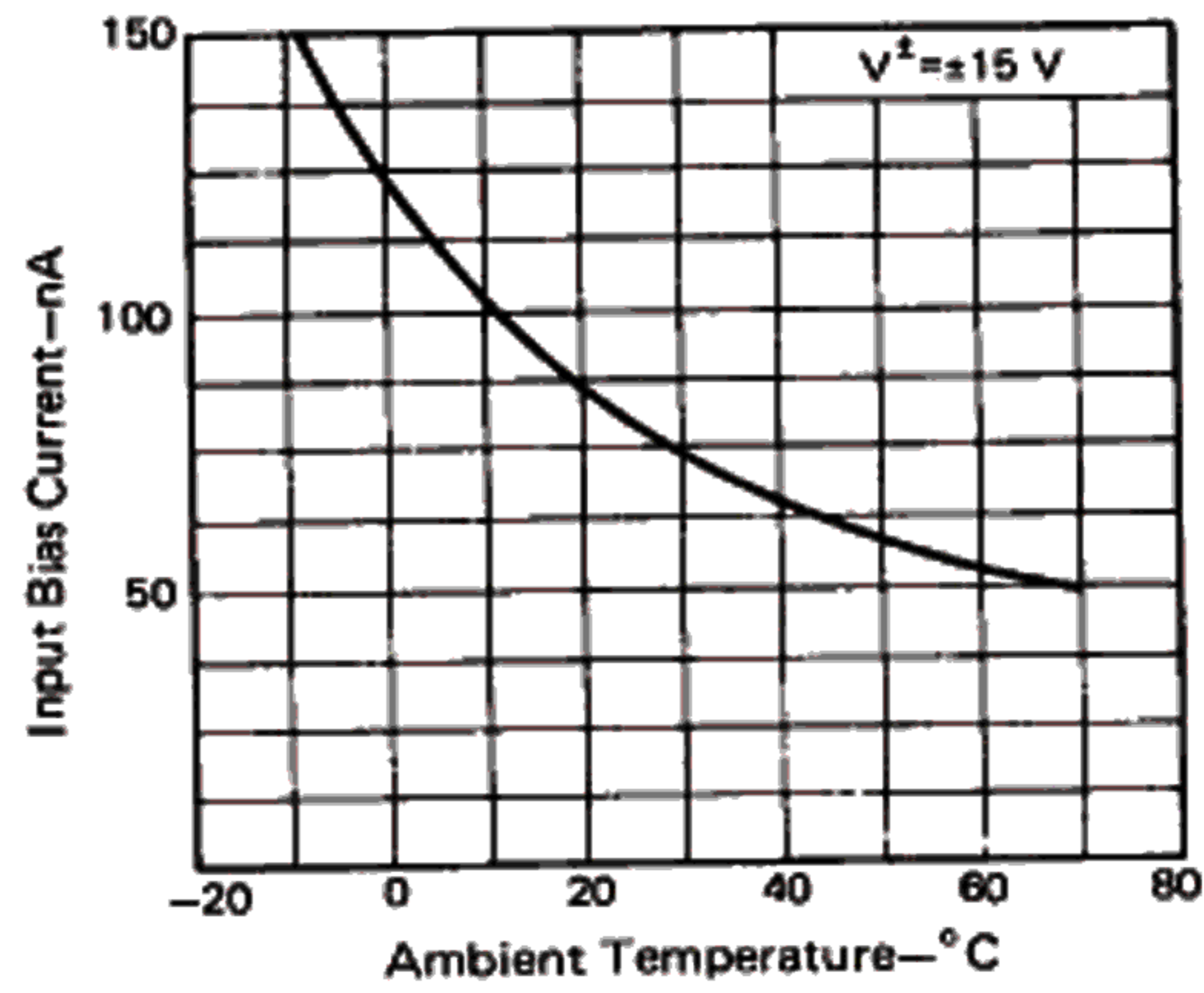

INPUT OFFSET CURRENT

