

RoHS Compliant Product  
A suffix of "-C" specifies halogen & lead-free

### FEATURE

- Excellent linearity of DC forward current gain.
- Low collector to emitter saturation voltage  
 $V_{CE(sat)}=0.3V$  max. (@  $I_C=100mA$ ,  $I_B=10mA$ )

### CLASSIFICATION OF $h_{FE}$

Product-Rank	2SC3052-E	2SC3052-F	2SC3052-G
Range	150~300	250~500	400~800
Marking	LE	LF	LG

### PACKAGE INFORMATION

Package	MPQ	LeaderSize
SOT-23	3K	7' inch

### SOT-23

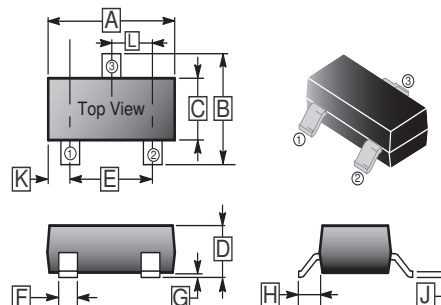

REF.	Millimeter		REF.	Millimeter	
	Min.	Max.		Min.	Max.
A	2.80	3.04	G	0.09	0.18
B	2.10	2.55	H	0.45	0.60
C	1.20	1.40	J	0.08	0.177
D	0.89	1.15	K	0.6 REF.	
E	1.78	2.04	L	0.89	1.02
F	0.30	0.50			

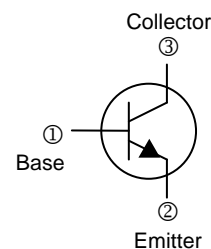

### ABSOLUTE MAXIMUM RATINGS ( $T_A = 25^\circ C$ unless otherwise specified)

Parameter	Symbol	Ratings	Unit
Collector to Base Voltage	$V_{CBO}$	50	V
Collector to Emitter Voltage	$V_{CEO}$	50	V
Emitter to Base Voltage	$V_{EBO}$	6	V
Collector Current - Continuous	$I_C$	200	mA
Collector Power Dissipation	$P_C$	150	mW
Junction, Storage Temperature	$T_J, T_{STG}$	125, -55~125	$^\circ C$

### ELECTRICAL CHARACTERISTICS ( $T_A = 25^\circ C$ unless otherwise specified)

Parameter	Symbol	Min.	Typ.	Max.	Unit	Test Conditions
Collector to Base Breakdown Voltage	$V_{(BR)CBO}$	50	-	-	V	$I_C=100\mu A, I_E=0$
Collector to Emitter Breakdown Voltage	$V_{(BR)CEO}$	50	-	-	V	$I_C=100\mu A, I_B=0$
Emitter to Base Breakdown Voltage	$V_{(BR)EBO}$	6	-	-	V	$I_E=100\mu A, I_C=0$
Collector Cut-Off Current	$I_{CBO}$	-	-	0.1	$\mu A$	$V_{CB}=50V, I_E=0$
Emitter Cut-Off Current	$I_{EBO}$	-	-	0.1	$\mu A$	$V_{EB}=6V, I_C=0$
DC Current Gain	$h_{FE(1)}$	150	-	800		$V_{CE}=6V, I_C=1mA$
	$h_{FE(2)}$	50	-	-		$V_{CE}=6V, I_C=0.1mA$
Collector to Emitter Saturation Voltage	$V_{CE(sat)}$	-	-	0.3	V	$I_C=100mA, I_B=10mA$
Base to Emitter Saturation Voltage	$V_{BE(sat)}$	-	-	1	V	$I_C=100mA, I_B=10mA$
Transition Frequency	$f_T$	180	-	-	MHz	$V_{CE}=6V, I_C=10mA$
Collector Output Capacitance	$C_{ob}$	-	-	4	pF	$V_{CE}=6V, I_E=0, f=1MHz$
Noise Figure	NF	-	-	15	dB	$V_{CE}=6V, I_E=-0.1mA, f=1KHz, R_G=2K\Omega$

**CHARACTERISTIC CURVES**

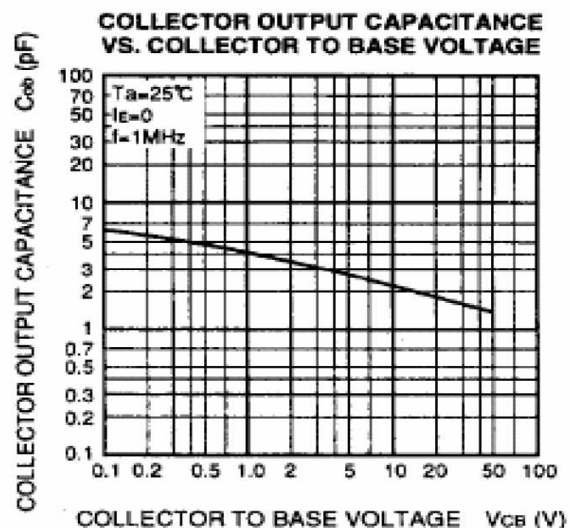
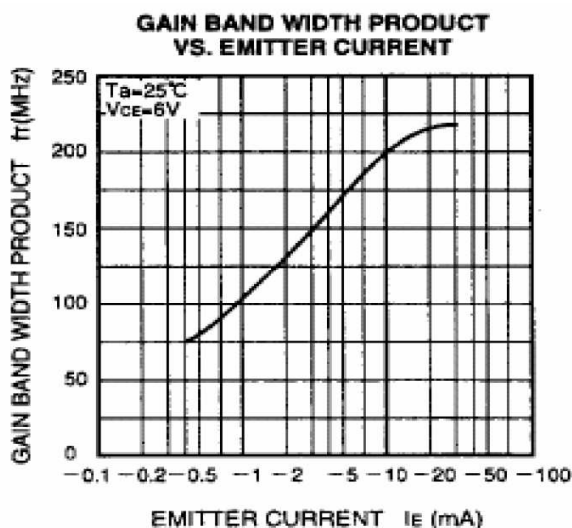
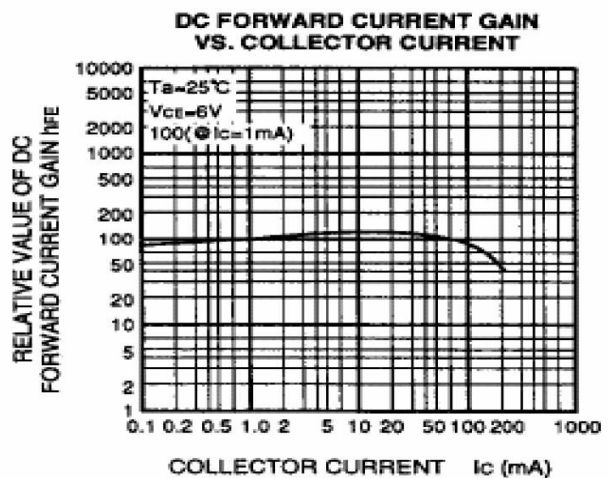
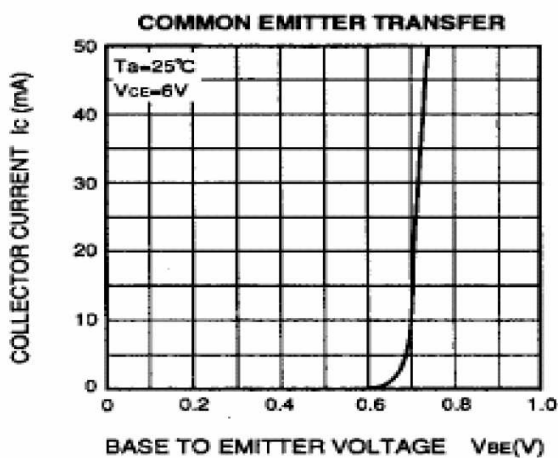
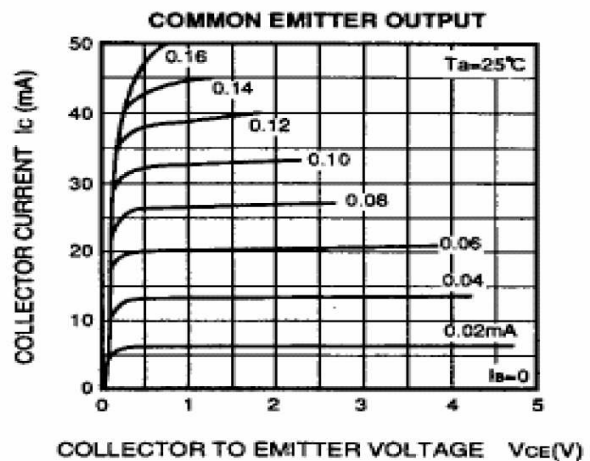
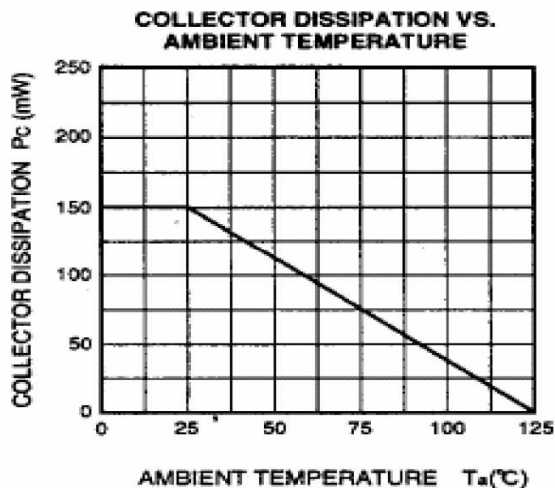

**CHARACTERISTIC CURVES**

