

描述 / Descriptions

TO-3P 塑封封装 NPN 半导体三极管。Silicon NPN transistor in a TO-3P Plastic Package.

特征 / Features

开关速度快，安全工作区宽。
High speed switching, wide SOA.

用途 / Applications

用于高压、大功率电源电路。
For high voltage, large power supply circuit.

内部等效电路 / Equivalent Circuit

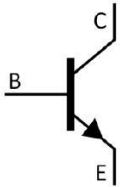

引脚排列 / Pinning

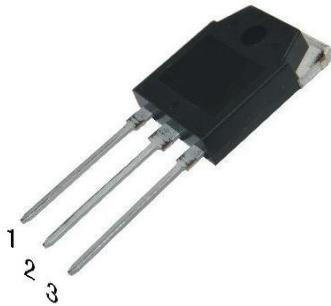

PIN1 : Base PIN 2 : Collector PIN 3 : Emitter

放大及印章代码 / h_{FE} Classifications & Marking

见印章说明。See Marking Instructions.

极限参数 / Absolute Maximum Ratings(Ta=25°C)

参数 Parameter	符号 Symbol	数值 Rating	单位 Unit
Collector to Base Voltage	V_{CBO}	1200	V
Collector to Emitter Voltage	V_{CEO}	800	V
Emitter to Base Voltage	V_{EBO}	7	V
Collector Current - Continuous	I_C	10	A
Peak Collector Current	I_{CP}	20	A
Base Current	I_B	4	A
Base Current Peak	I_{BP}	8	A
Collector Power Dissipation	$P_{C(TC=25^{\circ}C)}$	150	W
Junction Temperature	T_j	150	°C
Storage Temperature Range	T_{stg}	-55 ~ 150	°C
Thermal Resistance, Junction to Case	$R_{th(j-c)}$	0.83	°C/W

电性能参数 / Electrical Characteristics(Ta=25°C)

参数 Parameter	符号 Symbol	测试条件 Test Conditions	最小值 Min	典型值 Typ	最大值 Max	单位 Unit
Collector to Base Breakdown Voltage	V_{CBO}	$I_C=0.1mA$ $I_E=0$	1200			V
Collector to Emitter Breakdown Voltage	V_{CEO}	$I_C=0.2A$ $I_B=0$	800			V
Emitter to Base Breakdown Voltage	V_{EBO}	$I_E=0.1mA$ $I_C=0$	7			V
Collector Cut-Off Current	I_{CBO}	$V_{CB}=1200V$ $I_E=0$			100	μA
Collector Cut-Off Current	I_{CEO}	$V_{CE}=800V$ $I_B=0$			100	μA
Emitter Cut-Off Current	I_{EBO}	$V_{EB}=7V$ $I_C=0$			100	μA
DC Current Gain	$h_{FE(1)}$	$V_{CE}=5V$ $I_C=5A$	8		60	
	$h_{FE(2)}$	$V_{CE}=5V$ $I_C=1mA$	5			
Collector to Emitter Saturation Voltage	$V_{CE(sat)}$	$I_C=5A$ $I_B=1A$			1	V
Base to Emitter Saturation Voltage	$V_{BE(sat)}$	$I_C=5A$ $I_B=1A$			1.5	V
Transition Frequency	f_T	$V_{CE}=10V$ $I_C=1A$		8		MHz
Storage Time	t_s	UI9600 $I_C=0.5A$	1		9	μs

电参数曲线图 / Electrical Characteristic Curve

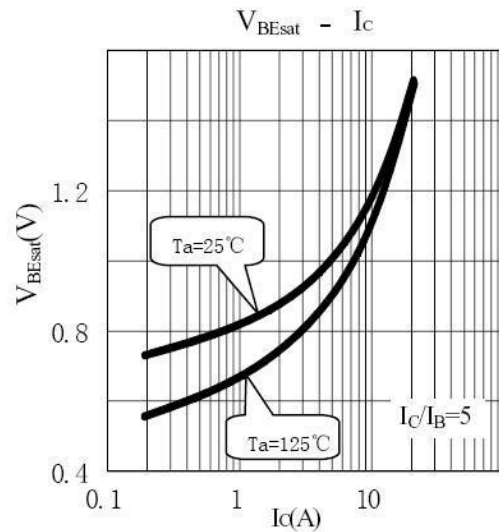
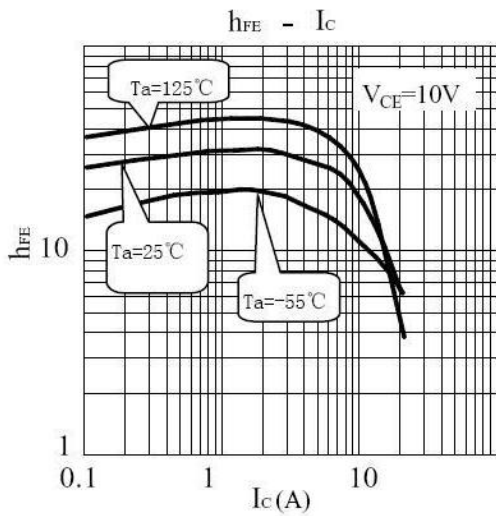
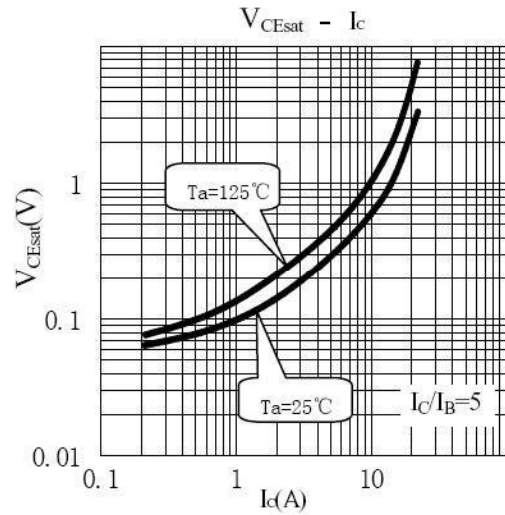
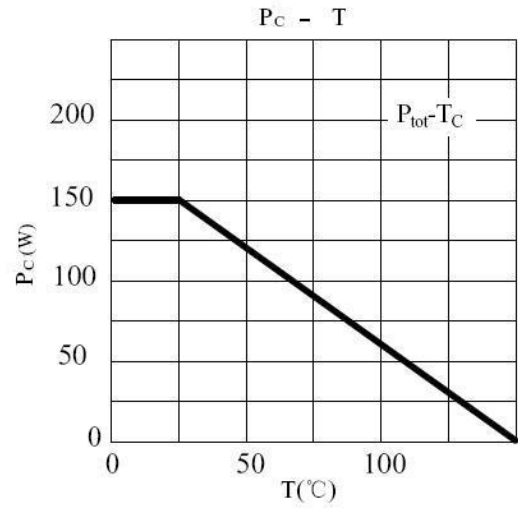
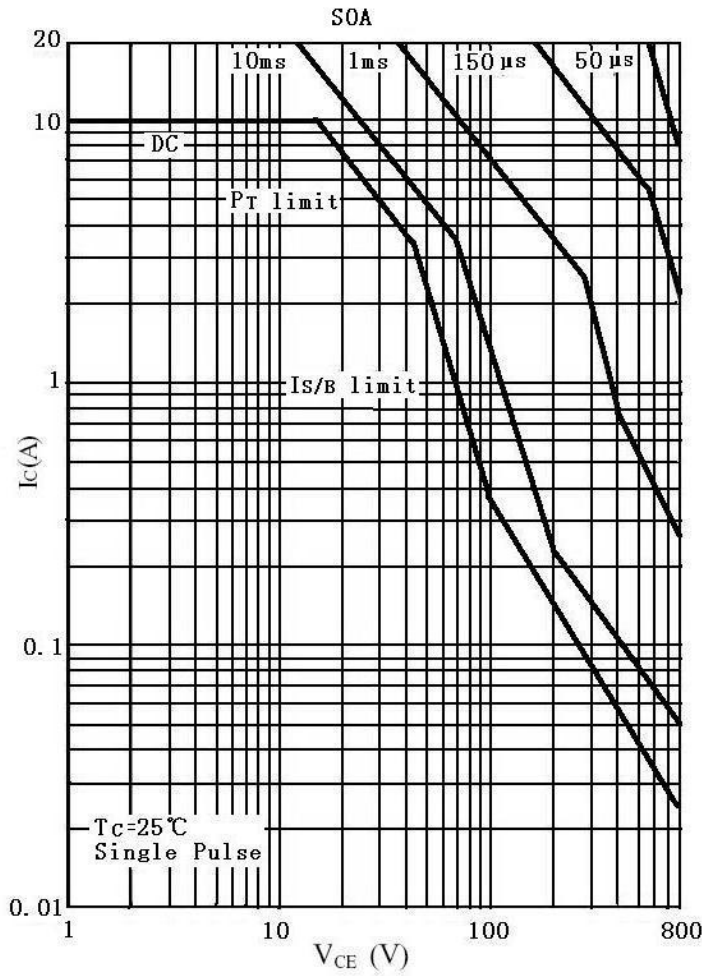

外形尺寸图 / Package Dimensions

TO-3P

单位: mm

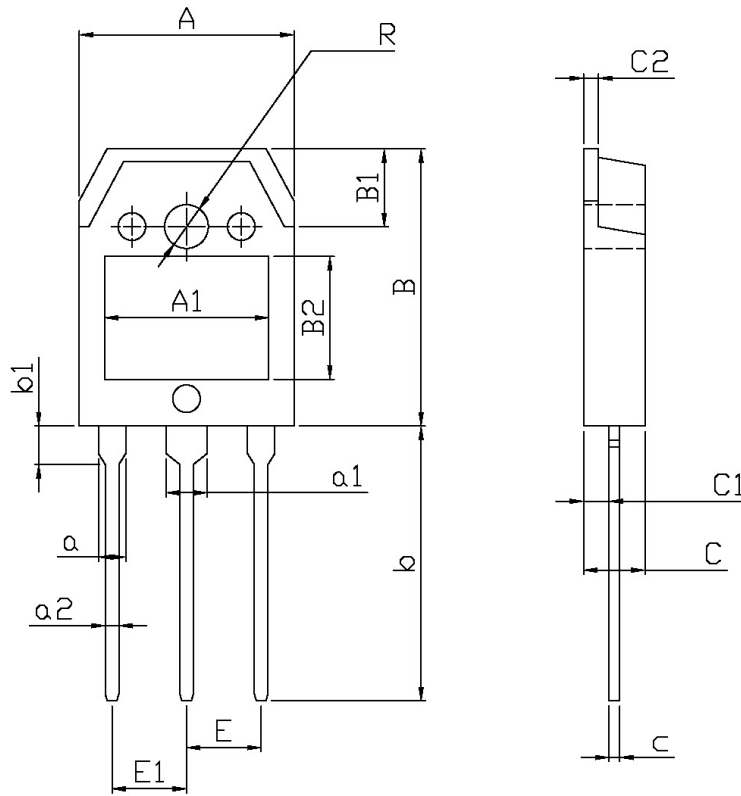

Symbol	Dimensions In Millimeters		Symbol	Dimensions In Millimeters	
	Min	Max		Min	Max
A	15.4	16.0	a2	0.8	1.2
R	3.1	3.5	E	5.45	
B	19.8	20.8	E1	5.45	
B1	5.5	5.9	C	4.3	4.7
B2	9.0		C1	1.2	1.6
A1	12.0		C2	1.4	1.6
b	19.6	20.6	c	0.5	0.7
b1	3.0	3.4			
a	1.8	2.2			
a1	2.8	3.2			

印章说明 / Marking Instructions

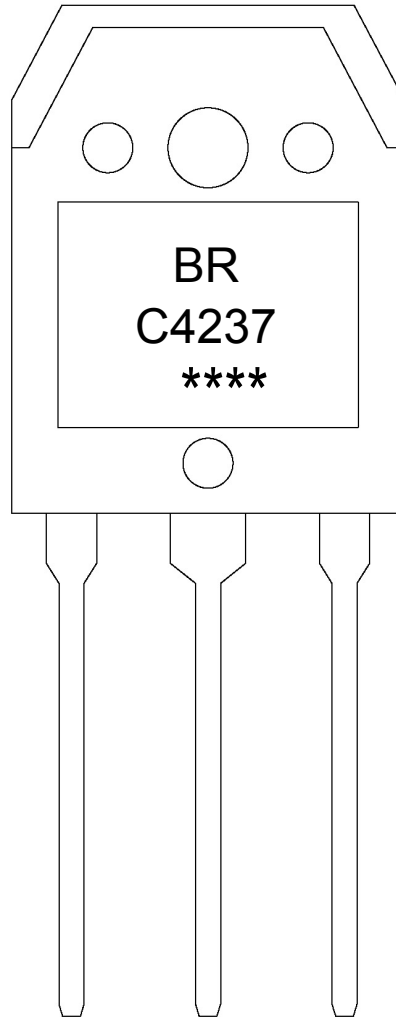

说明：

BR: 为公司代码

C4237 : 为型号代码

**** : 为生产批号代码，随生产批号变化。

Note:

BR: Company Code.

C4237: Product Type.

****: Lot No. Code, code change with Lot No.

波峰焊温度曲线图(无铅) / Temperature Profile for Dip Soldering(Pb-Free)

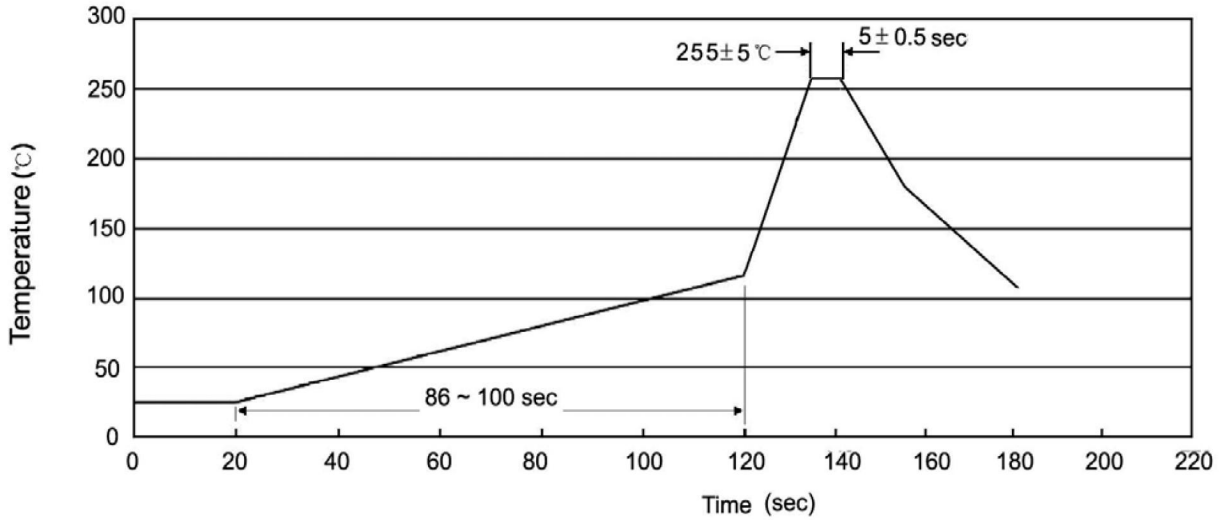

说明：

- 1、预热温度 25~150°C，时间 60~90sec;
- 2、峰值温度 255±5°C，时间持续为 5±0.5sec;
- 3、焊接制程冷却速度为 2~10°C/sec.

Note:

- 1.Preheating:25~150°C, Time:60~90sec.
- 2.Peak Temp.:255±5°C, Duration:5±0.5sec.
3. Cooling Speed: 2~10°C/sec.

耐焊接热试验条件 / Resistance to Soldering Heat Test Conditions

温度：270±5°C 时间：10±1 sec. Temp.:270±5°C Time:10±1 sec

包装规格 / Packaging SPEC.

套管包装 / TUBE

Package Type 封装形式	Units 包装数量					Dimension 包装尺寸 (unit: mm ³)		
	Units/Tube 只/套管	Tubes/Inner Box 套管/盒	Units/Inner Box 只/盒	Inner Boxes/Outer Box 盒/箱	Units/Outer Box 只/箱	Tube 套管	Inner Box 盒	Outer Box 箱
TO-3P	30	15	450	5	2250	497.5×46×8	555×164×50	575×290×180

使用说明 / Notices