

General Purpose High Current NPN Transistor Array

The CA3083 is a versatile array of five high current (to 100mA) NPN transistors on a common monolithic substrate. In addition, two of these transistors (Q₁ and Q₂) are matched at low current (i.e., 1mA) for applications in which offset parameters are of special importance.

Independent connections for each transistor plus a separate terminal for the substrate permit maximum flexibility in circuit design.

Ordering Information

PART NUMBER (BRAND)	TEMP. RANGE (°C)	PACKAGE	PKG. NO.
CA3083	-55 to 125	16 Ld PDIP	E16.3
CA3083M (3083)	-55 to 125	16 Ld SOIC	M16.15
CA3083M96 (3083)	-55 to 125	16 Ld SOIC Tape and Reel	M16.15

Pinout

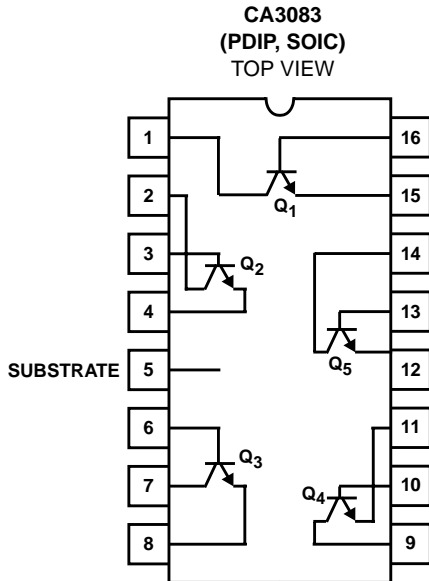

Features

- High I_C 100mA (Max)
- Low V_{CE sat} (at 50mA) 0.7V (Max)
- Matched Pair (Q₁ and Q₂)
 - V_{IO} (V_{BE} Match) ±5mV (Max)
 - I_{IO} (at 1mA) 2.5µA (Max)
- 5 Independent Transistors Plus Separate Substrate Connection

Applications

- Signal Processing and Switching Systems Operating from DC to VHF
- Lamp and Relay Driver
- Differential Amplifier
- Temperature Compensated Amplifier
- Thyristor Firing
- See Application Note AN5296 "Applications of the CA3018 Circuit Transistor Array" for Suggested Applications

Absolute Maximum Ratings

The following ratings apply for each transistor in the device:

Collector-to-Emitter Voltage, V_{CEO}	15V
Collector-to-Base Voltage, V_{CBO}	20V
Collector-to-Substrate Voltage, V_{CIO} (Note 1)	20V
Emitter-to-Base Voltage, V_{EBO}	5V
Collector Current (I_C)	100mA
Base Current (I_B)	20mA

Thermal Information

Thermal Resistance (Typical, Note 2)	θ_{JA} ($^{\circ}\text{C}/\text{W}$)	θ_{JC} ($^{\circ}\text{C}/\text{W}$)
PDIP Package	135	N/A
SOIC Package	200	N/A
Maximum Power Dissipation (Any One Transistor)	500mW	
Maximum Junction Temperature (Plastic Package)	150 $^{\circ}\text{C}$	
Maximum Storage Temperature Range	-65 $^{\circ}\text{C}$ to 150 $^{\circ}\text{C}$	
Maximum Lead Temperature (Soldering 10s)	300 $^{\circ}\text{C}$ (SOIC - Lead Tips Only)	

Operating Conditions

Temperature Range

CAUTION: Stresses above those listed in "Absolute Maximum Ratings" may cause permanent damage to the device. This is a stress only rating and operation of the device at these or any other conditions above those indicated in the operational sections of this specification is not implied.

NOTES:

- The collector of each transistor of the CA3083 is isolated from the substrate by an integral diode. The substrate must be connected to a voltage which is more negative than any collector voltage in order to maintain isolation between transistors and provide normal transistor action. To avoid undesired coupling between transistors, the substrate Terminal (5) should be maintained at either DC or signal (AC) ground. A suitable bypass capacitor can be used to establish a signal ground.
- θ_{JA} is measured with the component mounted on an evaluation PC board in free air.

Electrical Specifications For Equipment Design, $T_A = 25^{\circ}\text{C}$

PARAMETER	SYMBOL	TEST CONDITIONS	MIN	TYP	MAX	UNITS	
FOR EACH TRANSISTOR							
Collector-to-Base Breakdown Voltage	$V_{(BR)CBO}$	$I_C = 100\mu\text{A}$, $I_E = 0$	20	60	-	V	
Collector-to-Emitter Breakdown Voltage	$V_{(BR)CEO}$	$I_C = 1\text{mA}$, $I_B = 0$	15	24	-	V	
Collector-to-Substrate Breakdown Voltage	$V_{(BR)CIO}$	$I_{CI} = 100\mu\text{A}$, $I_B = 0$, $I_E = 0$	20	60	-	V	
Emitter-to-Base Breakdown Voltage	$V_{(BR)EBO}$	$I_E = 500\mu\text{A}$, $I_C = 0$	5	6.9	-	V	
Collector-Cutoff-Current	I_{CEO}	$V_{CE} = 10\text{V}$, $I_B = 0$	-	-	10	μA	
Collector-Cutoff-Current	I_{CBO}	$V_{CB} = 10\text{V}$, $I_E = 0$	-	-	1	μA	
DC Forward-Current Transfer Ratio (Note 3) (Figure 1)	h_{FE}	$V_{CE} = 3\text{V}$	$I_C = 10\text{mA}$	40	76	-	
			$I_C = 50\text{mA}$	40	75	-	
Base-to-Emitter Voltage (Figure 2)	V_{BE}	$V_{CE} = 3\text{V}$, $I_C = 10\text{mA}$	0.65	0.74	0.85	V	
Collector-to-Emitter Saturation Voltage (Figures 3, 4)	$V_{CE\text{ SAT}}$	$I_C = 50\text{mA}$, $I_B = 5\text{mA}$	-	0.40	0.70	V	
Gain Bandwidth Product	f_T	$V_{CE} = 3\text{V}$, $I_C = 10\text{mA}$	-	450	-	MHz	
FOR TRANSISTORS Q₁ AND Q₂ (As a Differential Amplifier)							
Absolute Input Offset Voltage (Figure 6)	$ V_{IO} $	$V_{CE} = 3\text{V}$, $I_C = 1\text{mA}$	-	1.2	5	mV	
Absolute Input Offset Current (Figure 7)	$ I_{IO} $	$V_{CE} = 3\text{V}$, $I_C = 1\text{mA}$	-	0.7	2.5	μA	

NOTE:

- Actual forcing current is via the emitter for this test.

Typical Performance Curves

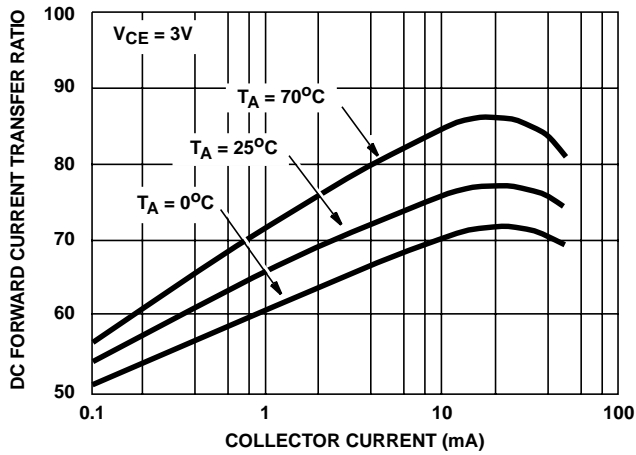

FIGURE 1. h_{FE} vs I_C

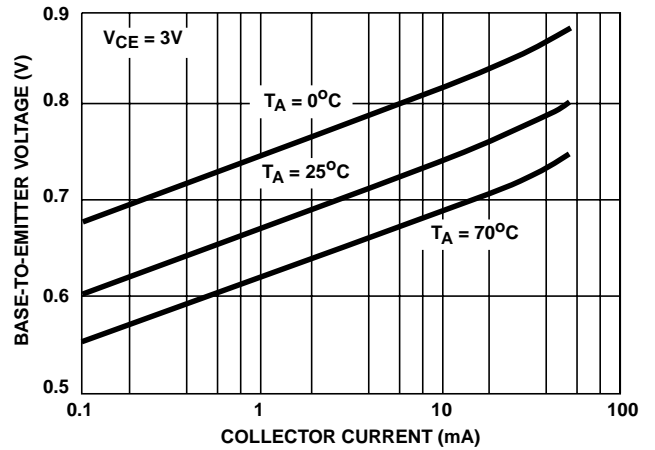

FIGURE 2. V_{BE} vs I_C

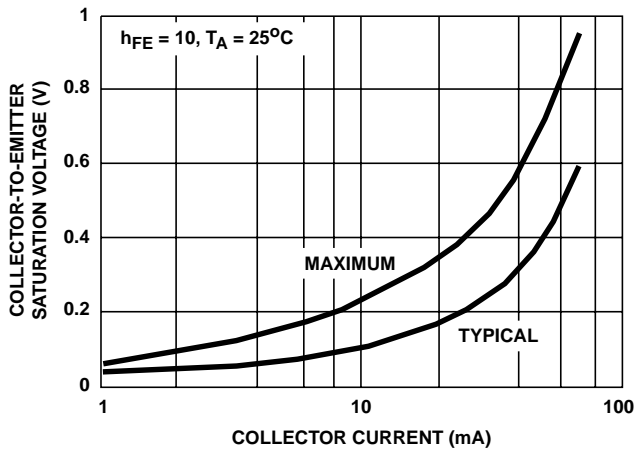

FIGURE 3. $V_{CE SAT}$ vs I_C

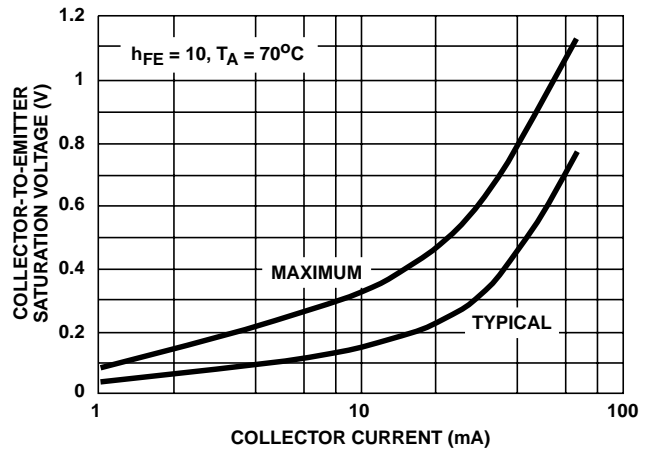

FIGURE 4. $V_{CE SAT}$ vs I_C

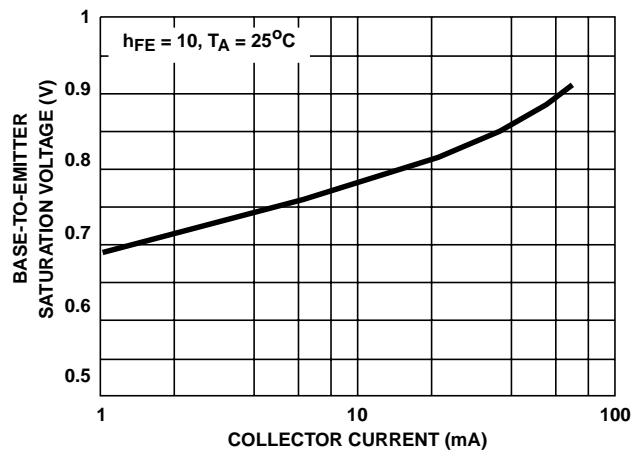

FIGURE 5. $V_{BE SAT}$ vs I_C

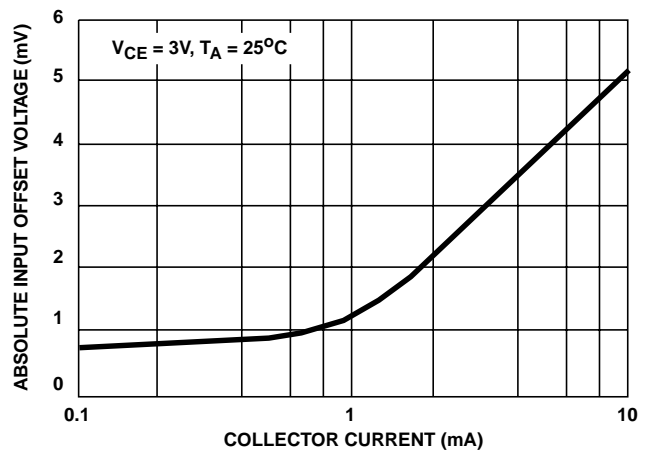

FIGURE 6. V_{IO} vs I_C (TRANSISTORS Q_1 AND Q_2 AS A DIFFERENTIAL AMPLIFIER)

Typical Performance Curves (Continued)

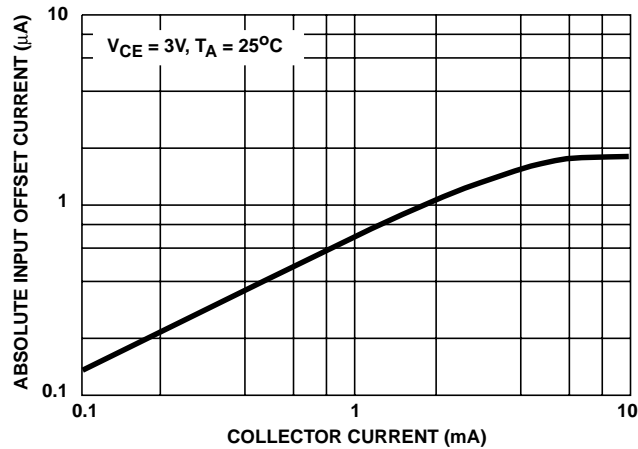

FIGURE 7. I_O vs I_C (TRANSISTORS Q_1 AND Q_2 AS A DIFFERENTIAL AMPLIFIER)

All Intersil semiconductor products are manufactured, assembled and tested under **ISO9000** quality systems certification.

Intersil semiconductor products are sold by description only. Intersil Corporation reserves the right to make changes in circuit design and/or specifications at any time without notice. Accordingly, the reader is cautioned to verify that data sheets are current before placing orders. Information furnished by Intersil is believed to be accurate and reliable. However, no responsibility is assumed by Intersil or its subsidiaries for its use; nor for any infringements of patents or other rights of third parties which may result from its use. No license is granted by implication or otherwise under any patent or patent rights of Intersil or its subsidiaries.

For information regarding Intersil Corporation and its products, see web site www.intersil.com

Sales Office Headquarters

NORTH AMERICA

Intersil Corporation
P. O. Box 883, Mail Stop 53-204
Melbourne, FL 32902
TEL: (321) 724-7000
FAX: (321) 724-7240

EUROPE

Intersil SA
Mercure Center
100, Rue de la Fusee
1130 Brussels, Belgium
TEL: (32) 2.724.2111
FAX: (32) 2.724.22.05

ASIA

Intersil (Taiwan) Ltd.
7F-6, No. 101 Fu Hsing North Road
Taipei, Taiwan
Republic of China
TEL: (886) 2 2716 9310
FAX: (886) 2 2715 3029