

# CA30CAxxBPxIO - IO-Link



## Capacitive Proximity Sensors with IO-Link communication



### Description

The new generation of CA30CA...IO sensors are a complete family of high performance capacitive sensors for detection of most solid or liquid targets in industrial applications such as Plastic & Rubber, Agriculture, Food & Beverage and Materials handling. The 4<sup>th</sup> Generation of TRIPLESIELD™ technology provides increased immunity to electromagnetic interference (EMI), especially to frequency drives, and improves immunity to humidity and dust.

The sensor housing has the IP69K rating as well as approval by ECOLAB for cleaning and disinfection agents.

On-board IO-Link communication opens up a variety of functions, such as easy communication and customization of advanced parameter settings.

### Benefits

- **A complete family.** Available in M30 in a robust PBT housing with an operation of 2-20 mm flush or 4-30 mm non-flush.
- **Enhanced EMC performance:** 4<sup>th</sup> Generation TRIPLESIELD™
- **Easy customization to specific OEM requests:** different cable lengths and materials, special labelling: customized pig-tail solutions with special cables and connectors are possible on request..
- **The output** can be operated either as a switching output or in IO-Link mode.
- **Fully configurable via output IO-Link v 1.1.** Electrical outputs can be configured as PNP / NPN / Push-Pull / External input, normally open or normally closed.
- **Timer functions** can be set, such as ON-delay, Off-delay, and one shots.
- **Logging functions:** Temperatures, detecting counter, power cycles and operating hours.
- **Detection modes** Single point, two point and windows mode.
- **Analogue output:** In IO-Link mode the sensor will generate 16 bit analogue process data output representing the dielectric value measured by the sensor.



## IO-Link

### Applications

- Detection not only of the level of plastic pellets in plastic moulding machines but also the dielectric value of the pellets to ensure correct manufacturing.
- Detection not only of the wood pellets in pellet burners but also the density of the wood pellets.

### Main functions

- The sensor can be operated in IO-Link mode once connected to an IO-Link master or in standard I/O mode.
- Adjustable parameters via IO-Link interface:
  - ▶ Sensing distance and hysteresis.
  - ▶ Sensing modes: single point or two point or window mode.
  - ▶ Timer functions, e.g.: On-delay, Off delay, One shot leading edge or trailing edge.
  - ▶ Logic functions such as: AND, OR, X-OR and SR-FF.
  - ▶ External input.
  - ▶ Logging functions: Maximum temperatures, minimum temperatures, operating hours, operating cycles, power cycles, minutes above maximum temperature, minutes below minimum temperature, etc.

## References

### Product selection key

 CA30CA   BP  IO

 Enter the code option instead of 

Code	Option	Description
C	-	Sensing principle: Capacitive sensor
A	-	Cylindrical housing with threaded barrel
30	-	Housing diameter (mm)
C	-	Plastic housing - PBT
A	-	Axial sensing
<input type="checkbox"/>	F	Flush installation
	N	Non-flush installation
<input type="checkbox"/>	16	Sensing distance: 16 mm
	25	Sensing distance: 25 mm
B	-	<b>Selectable functions:</b> NPN, PNP, Push-Pull, External Input (only pin 2) or External teach input (only pin 2)
P	-	<b>Selectable:</b> N.O. or N.C.
<input type="checkbox"/>	A2	2 metre PVC cable
	M1	M12, 4-pole connector
IO	-	IO-Link version

Additional characters can be used for customized versions.

### Type selection

Connection	Distance	Mounting	Code
Cable	16 mm	Flush	CA30CAF16BPA2IO
	25 mm	Non-flush	CA30CAN25BPA2IO
Plug	16 mm	Flush	CA30CAF16BPM1IO
	25 mm	Non-flush	CA30CAN25BPM1IO

## Structure

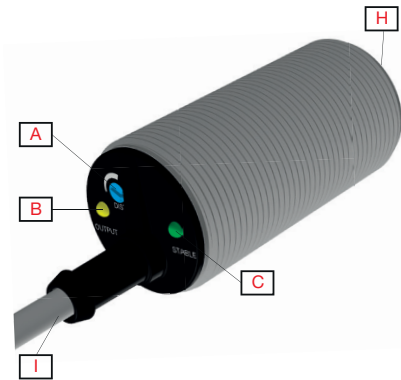

Fig. 1 CA30 Cable

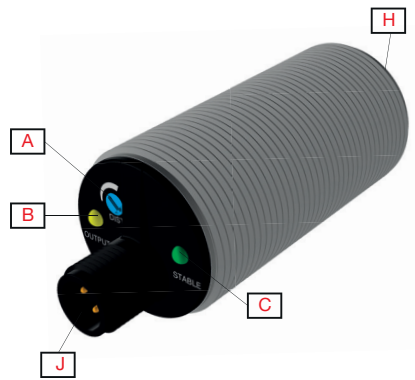

Fig. 2 CA30 Plug

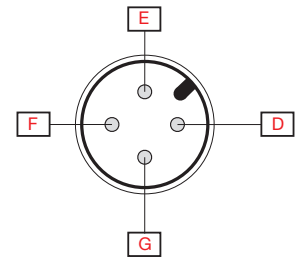
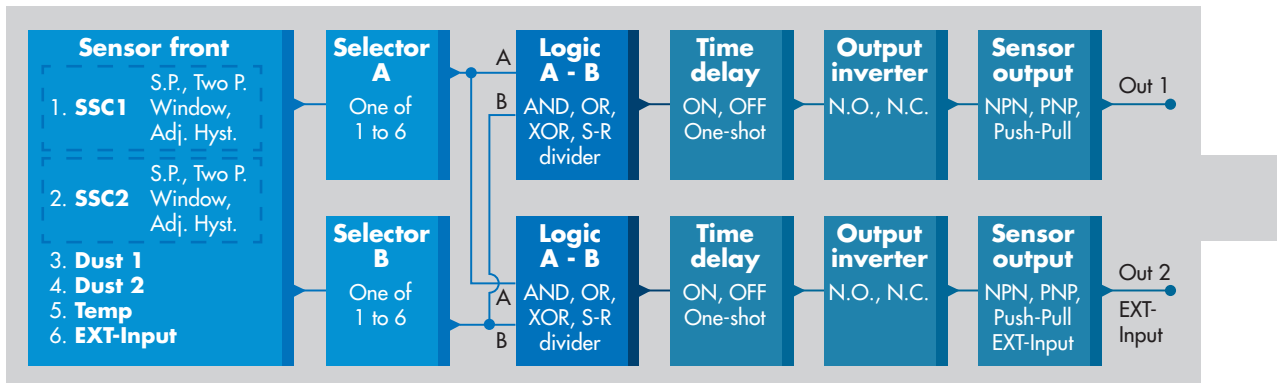

Fig. 3 Colour code

A	Sensitivity adjustment	F	Blue
B	Yellow LED	G	Black
C	Green LED	H	Sensing face
D	Brown	I	2 m, 4 wire PVC Ø 5,2 mm cable
E	White	J	M12x1, 4-pin male connector

# Sensing

## Detection



<b>Sensor switching channel SSC1 and SSC2</b>	<b>SSC1</b> <ul style="list-style-type: none"> <li>• Enabled</li> <li>• Disabled</li> </ul> <b>Factory settings:</b> Enabled	<b>SSC2</b> <ul style="list-style-type: none"> <li>• Enabled</li> <li>• Disabled</li> </ul> <b>Factory settings:</b> Enabled
<b>Switching mode</b>	<b>SSC1</b> <ul style="list-style-type: none"> <li>• Deactivated</li> <li>• Single point mode</li> <li>• Two point mode</li> <li>• Windows mode</li> </ul> <b>Factory settings:</b> Single point mode	<b>SSC2</b> <ul style="list-style-type: none"> <li>• Deactivated</li> <li>• Single point mode</li> <li>• Two point mode</li> <li>• Windows mode</li> </ul> <b>Factory settings:</b> Single point mode
<b>Rated operating distance (S<sub>n</sub>)</b>	0 - 25 mm ( <b>Factory settings:</b> 25 mm), (ref. target 36x36 mm ST37, 1 mm thick, grounded)	Non-flush-mounted sensor
	0 - 16 mm ( <b>Factory settings:</b> 16 mm), (ref. target 24x24 mm ST37, 1 mm thick, grounded)	Flush-mounted sensor
<b>Sensitivity control</b>	Adjustable by potentiometer, external teach or by IO-Link settings <ul style="list-style-type: none"> <li>• Potentiometer disabled</li> <li>• Potentiometer enabled</li> <li>• External teach</li> </ul> <b>Factory settings:</b> Potentiometer enabled	
<b>Potentiometer</b>	Electrical adjustment	11 turns
	Mechanical adjustment	16 turns
<b>Adjustable distance</b>	2 ... 20 mm (flush types) <b>Factory settings:</b> SP1 1000 and SP2 10000	
	4 ... 30 mm (Non- flush types) <b>Factory settings:</b> SP1 1000 and SP2 10000	
<b>Effective operating distance (S<sub>r</sub>)</b>	$0.9 \times S_n \leq S_r \leq 1.1 \times S_n$	
<b>Usable operating dist. (S<sub>u</sub>)*</b>	$0.85 \times S_r \leq S_u \leq 1.15 \times S_r$	
<b>Hysteresis (H)</b> CA30CAF16... CA30CAN25...	Adjustable by IO-Link (1% to 100%) <b>Factory settings:</b> Typical 7% <b>Factory settings:</b> Typical 10%	
<b>Detection filter</b>	This function can increase the immunity towards unstable targets and electromagnetic disturbances: Value can be set from 1 to 255. <b>Factory settings:</b> 1 (1 is max. operating frequency and 255 is min. operating frequency)	



\* For Flush-mounted sensors in conductive material, the usable operating distance ( $S_u$ ) is  $0.80 \times S_r \leq S_u \leq 1.2 \times S_r$  for temperatures exceeding  $0^\circ\text{C} - 60^\circ\text{C}$  ( $32^\circ\text{F} - 140^\circ\text{F}$ ).

### ▶ Alarm settings

<b>Dust alarm SSC1 and SSC2</b>	<b>SSC1</b> • 0 to 100 % of actual SP <b>Factory settings:</b> 2 times standard hysteresis	<b>SSC2</b> • 0 to 100 % of actual SP <b>Factory settings:</b> 2 times standard hysteresis
<b>Temperature alarm</b>	• High threshold -50 to +150 °C • Low threshold -50 to +150 °C <b>Factory settings:</b> <i>High value 120 °C (front temperature sensor used)</i> <i>Low value -30 °C (front temperature sensor used)</i>	

**Detection diagram**

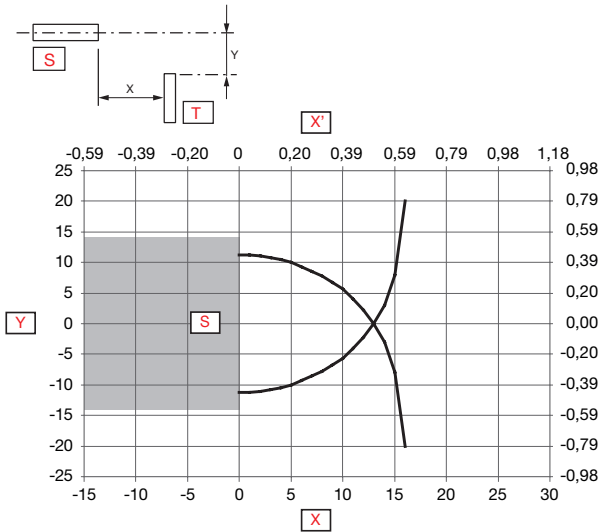

Fig. 4 Flush

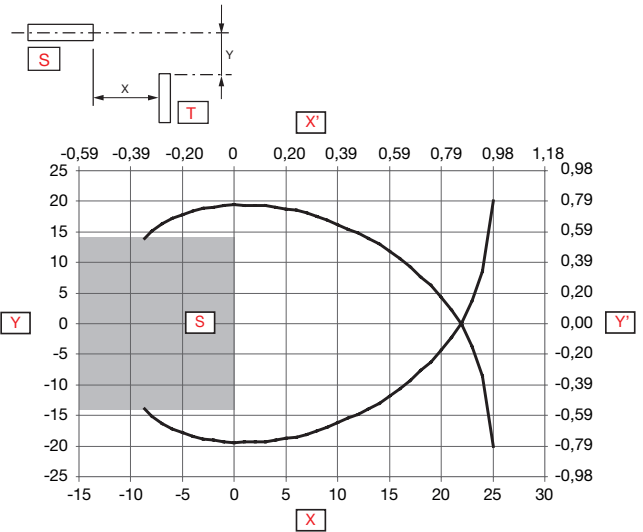

Fig. 5 Non-flush

<b>Y</b>	Detection width [mm]	<b>X'</b>	Sensing range [inches]
<b>X</b>	Sensing range [mm]	<b>S</b>	Sensor
<b>Y'</b>	Detection width [inches]	<b>T</b>	Target

**Accuracy**

Repeat accuracy (R)	≤ 5%
---------------------	------

**Operation diagram**

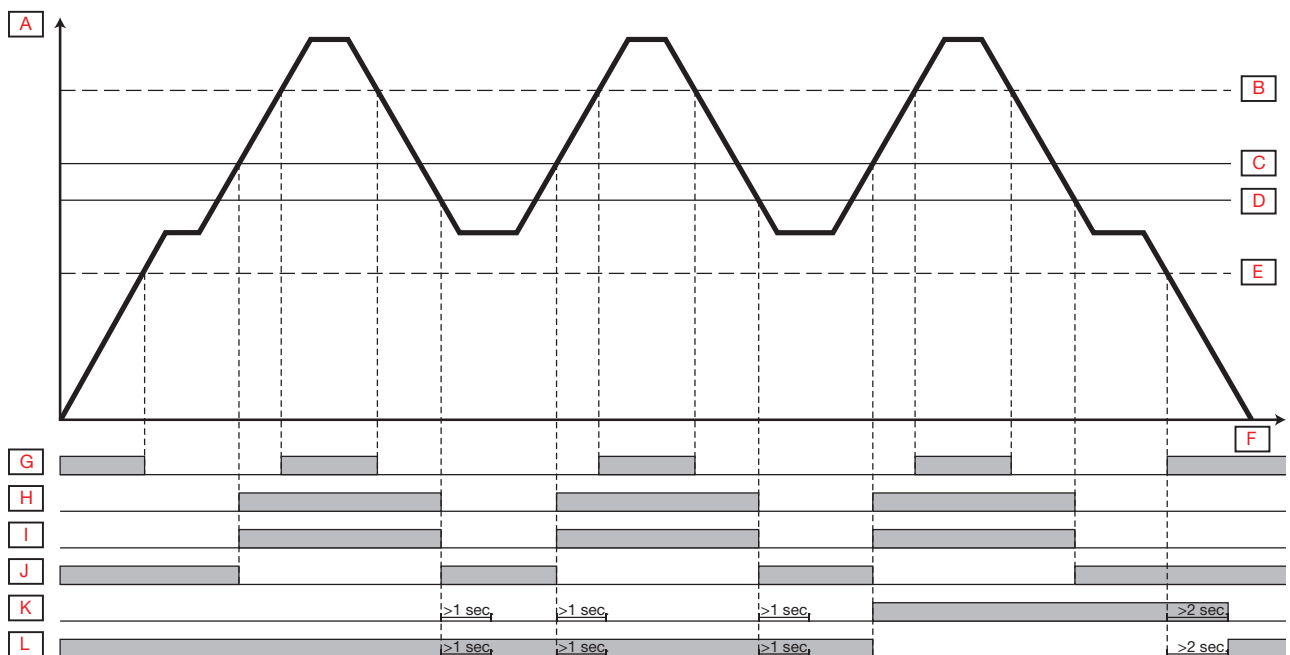



<b>A</b>	Target influence	<b>G</b>	Green LED ON
<b>B</b>	stable ON	<b>H</b>	Yellow LED ON
<b>C</b>	Output ON	<b>I</b>	Output N.O.
<b>D</b>	Output OFF	<b>J</b>	Output N.C.
<b>E</b>	stable OFF	<b>K</b>	Dust alarm N.O.
<b>F</b>	Time	<b>L</b>	Dust alarm N.C.



## Features

### Power Supply

Rated operational voltage ( $U_B$ )	10 ... 40 VDC (ripple included)
Ripple ( $U_{rpp}$ )	$\leq 10\%$
No load supply current ( $I_o$ )	$\leq 20$ mA
Rated insulation voltage ( $U_i$ )	50 VDC
Power-ON delay (tv)	$\leq 300$ ms

### Input selector

Input selector	<b>Channel A</b> <ul style="list-style-type: none"> <li>• Deactivated</li> <li>• SSC1</li> <li>• SSC2</li> <li>• Dust alarm 1</li> <li>• Dust alarm 2</li> <li>• Temperature alarm</li> <li>• External input</li> </ul> <b>Factory settings: SSC1</b>	<b>Channel B</b> <ul style="list-style-type: none"> <li>• Deactivated</li> <li>• SSC1</li> <li>• SSC2</li> <li>• Dust alarm 1</li> <li>• Dust alarm 2</li> <li>• Temperature alarm</li> <li>• External input</li> </ul> <b>Factory settings: SSC1</b>
----------------	---	---

### Logic functions

Logic functions	<b>Channel A + B for SO1</b> <ul style="list-style-type: none"> <li>• Direct</li> <li>• AND</li> <li>• OR</li> <li>• X-OR</li> <li>• SR-FF</li> </ul> <b>Factory settings: Direct</b>	<b>Channel A + B for SO2</b> <ul style="list-style-type: none"> <li>• Direct</li> <li>• AND</li> <li>• OR</li> <li>• X-OR</li> <li>• SR-FF</li> </ul> <b>Factory settings: Direct</b>
-----------------	---	---

### Time delays

<b>Timer mode</b>	<b>For SO1</b> <ul style="list-style-type: none"> <li>• Disabled</li> <li>• Power-ON delay</li> <li>• Power-OFF delay</li> <li>• Power-ON delay and Power-OFF delay</li> <li>• One-shot leading edge</li> <li>• One-shot trailing edge</li> </ul> <b>Factory settings: Disabled</b>	<b>For SO2</b> <ul style="list-style-type: none"> <li>• Disabled</li> <li>• Power-ON delay</li> <li>• Power-OFF delay</li> <li>• Power-ON delay and Power-OFF delay</li> <li>• One-shot leading edge</li> <li>• One-shot trailing edge</li> </ul> <b>Factory settings: Disabled</b>
<b>Timer scale</b>	<b>For SO1</b> <ul style="list-style-type: none"> <li>• [ms]</li> <li>• [s]</li> <li>• [min]</li> </ul> <b>Factory settings: ms</b>	<b>For SO2</b> <ul style="list-style-type: none"> <li>• [ms]</li> <li>• [s]</li> <li>• [min]</li> </ul> <b>Factory settings: ms</b>
<b>Timer value</b>	<b>For SO1</b> <ul style="list-style-type: none"> <li>• 0 ... 32 767</li> </ul> <b>Factory settings: 0</b>	<b>For SO2</b> <ul style="list-style-type: none"> <li>• 0 ... 32 767</li> </ul> <b>Factory settings: 0</b>

### Output Inverter

<b>Output Inverter</b>	<b>For SO1 Pin 4 Black wire:</b> <ul style="list-style-type: none"> <li>• N.O.</li> <li>• N.C.</li> </ul> <b>Factory settings: N.O.</b>	<b>For SO2 Pin 2 White wire:</b> <ul style="list-style-type: none"> <li>• N.O.</li> <li>• N.C.</li> </ul> <b>Factory settings: N.C.</b>
------------------------	---	---

### Sensor Output

<b>Switching Output Stage SO1 and SO2</b>	<b>For SO1 Pin 4 Black wire:</b> <ul style="list-style-type: none"> <li>• NPN</li> <li>• PNP</li> <li>• Push-Pull</li> </ul> <b>Factory settings: PNP</b>	<b>For SO2 Pin 2 White wire:</b> <ul style="list-style-type: none"> <li>• NPN</li> <li>• PNP</li> <li>• Push-Pull</li> <li>• External input, active high</li> <li>• External input, active low</li> <li>• External teach</li> </ul> <b>Factory settings: PNP</b>
---	---	--

### Outputs

<b>Rated operational current (<math>I_o</math>) (<math>I_e</math>)</b>	≤ 200 mA (Continuous, SO1 + SO2)	
<b>OFF-state current (<math>I_o</math>)</b>	≤ 100 μA	
<b>Minimum operational current (<math>I_m</math>)</b>	> 0,5 mA	
<b>Voltage drop (<math>U_d</math>)</b>	≤ 1.0 VDC @ 200 mA DC	
<b>Protection</b>	Short circuit, reverse polarity, transients	
<b>Utilization category</b>	DC-12	Control of resistive loads and solid-state loads with optical isolation
	DC-13	Control of electromagnets
<b>Load capacitance max at (<math>U_o</math>)</b>	100 nF	

## Operation diagram

### For default factory sensor

$T_v$  = Power-ON delay

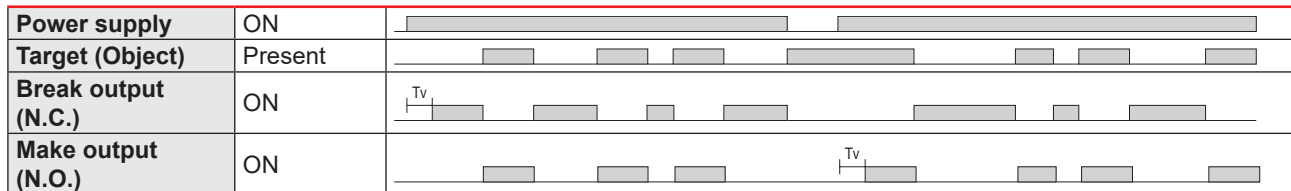

## Response times

<b>Operating frequency (f)</b>	50 Hz.	
<b>Response times</b>	$t_{ON}$ (OFF-ON)	< 10 ms
	$t_{OFF}$ (ON-OFF)	< 10 ms

## Indication

Green LED	Yellow LED	Power	Function
<b>SIO and IO-Link mode</b>			
ON	ON	ON	ON (stable)* SSC1
ON	OFF	ON	OFF (stable)* SSC1
OFF	ON	-	ON (Not stable) SSC1
OFF	OFF	-	OFF (Not stable) SSC1
-	Flashing 10 Hz 50% dutycycle	ON	Output short-circuit
-	Flashing (0.5...20 Hz)	ON	Timer indication
<b>SIO mode only</b>			
-	Flashing 1 HZ ON 100 ms OFF 900 ms	ON	External teach by wire. Only for single point mode
-	Flashing 1 HZ ON 900 ms OFF 100 ms	ON	Teach time window (3 - 6 sec)
-	Flashing 10 HZ ON 50 ms OFF 50 ms Flashing for 2 sec	ON	Teach time out (12 sec)
-	Flashing 2 HZ ON 250 ms OFF 250 ms Flashing for 2 sec	ON	Teach successful
<b>IO-Link mode only</b>			
Flashing 1 HZ ON 900 ms OFF 100 ms	-	ON	Sensor is in IO-Link mode

\*See operation diagram

### LED indication

LED indications	<ul style="list-style-type: none"> <li>• LED Indication disabled</li> <li>• LED Indication enabled</li> </ul> <b>Factory settings:</b> LED Indication enabled
-----------------	---

### Environmental

Ambient temperature	-30°C... +85°C (-22°F... +185°F)	Operating
	-40°C ... +85°C (-40°F ... +185°F)	Storage
Max. temperature on sensing face	120°C (248°F)	
Ambient humidity range	35% ... 95%	Operating
	35% ... 95%	Storage
Vibration	10 ... 150 Hz, 1 mm / 15 G	EN 60068-2-6
Shock	30 G / 11 ms, 3 pos, 3 neg per axis	EN 60068-2-27
Drop test	2 x 1 m 100 x 0,5 m	EN 60068-2-31
Rated impulse withstand voltage	≥2 kV	with 500 Ω
Overvoltage category	III	IEC 60664, EN 60947-1
Pollution degree	3	IEC 60664, 60664A; EN 60947-1
IP rating	IP 67, IP 68/60 min.,	EN 60529; EN 60947-1
	IP69K*	DIN 40050-9
NEMA Enclosure Types	1, 2, 4, 4X, 5, 6, 6P, 12	NEMA 250
Tightening torque	≤ 7.5 Nm	

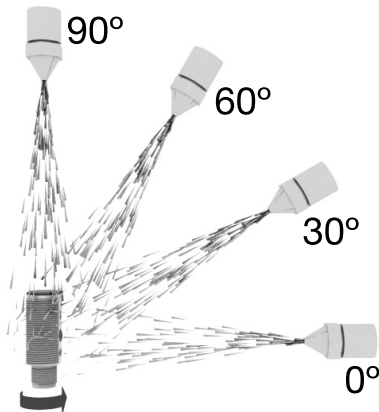

\* The IP69K test according to DIN 40050-9 for high-pressure, high-temperature wash-down applications. The sensor must not only be dust tight (IP6X), but also able to withstand high-pressure and steam cleaning. The sensor is exposed to high pressure water from a spray nozzle that is fed with 80°C water at 8'000– 10'000 KPa (80–100bar) and a flow rate of 14–6L/min. The nozzle is held 100 –150 mm from the sensor at angles of 0°, 30°, 60° and 90° for 30s each. The test device sits on a turntable that rotates with a speed of 5 times per minute. The sensor must not suffer any damaging effects in appearance or function from the high pressure water function.

### TRIPLESIELD™

Exceeding the norms for capacitive sensors.

Electrostatic discharge immunity test	contact discharge	> 40 kV	IEC 61000-4-2; EN60947-1
	air discharge	> 40 kV	
Electromagnetic field immunity	20 V/m		IEC 61000-4-3; EN60947-1
Electrical fast transient immunity	±4kV / 5kHz		IEC 61000-4-4; EN60947-1
Wire-conducted noise	> 20 Vrms		IEC 61000-4-3; EN60947-1
Power frequency magnetic fields	Continuous	> 60 A/m, 75.9 μ tesla	IEC 61000-4-8; EN60947-1
	Short-time	> 600 A/m, 759 μ tesla	

### Diagnostic parameters

Function	Unit	Range
<b>Values stored in the sensor (Saved every hour)</b>		
Operating Hours	[h]	0 ... 2 147 483 647
Number of Power Cycles	[cycles]	0 ... 2 147 483 647
Maximum temperature - All time high	[°C]	-50 ... +150
Minimum temperature - All time low	[°C]	-50 ... +150
Detection counter SSC1	[cycles]	0 ... 2 147 483 647
Minutes above Maximum Temperature	[min]	0 ... 2 147 483 647
Minutes below Minimum Temperature	[min]	0 ... 2 147 483 647
<b>Values stored in the sensor (Saved with events)</b>		
Maintenance event counter	[counts]	0 ... 2 147 483 647
Download counter	[counts]	0 ... 65 536
<b>Values not saved in sensor</b>		
Maximum temperature - Since last power-up	[°C]	-50 ... +150
Minimum temperature - Since last power-up	[°C]	-50 ... +150
Current temperature	[°C]	-50 ... +150

### Events Configuration

Events	Factory default setting
Temperature fault event	Inactive
Temperature over-run	Inactive
Temperature under-run	Inactive
Short circuit	Inactive
Maintenance	Inactive

 Process data configuration

Process Data	Factory default setting
Analogue value	Active
SO1, Switching output 1	Active
SO2, Switching output 2	Active
SSC1, Sensor switching channel 1	Inactive
SSC2, Sensor switching channel 2	Inactive
DA1, Dust Alarm for SSC1	Inactive
DA2, Dust alarm for SSC2	Inactive
TA, Temperature alarm	Inactive
SC, Short circuit	Inactive

## Process data structure

4 Bytes, Analogue value 16 ... 31 (16 bit)

Byte 0	31	30	29	28	27	26	25	24
	<b>MSB</b>	-	-	-	-	-	-	-
Byte 1	23	22	21	20	19	18	17	16
	-	-	-	-	-	-	-	<b>LSB</b>
Byte 2	15	14	13	12	11	10	9	8
	-	-	<b>SC</b>	<b>TA</b>	<b>DA2</b>	<b>DA1</b>	<b>SSC2</b>	<b>SSC1</b>
Byte 3	7	6	5	4	3	2	1	0
	-	-	-	-	-	-	<b>SO2</b>	<b>SO1</b>

## Mechanics/electronics

### Connection

<b>Cable</b>	2 m, 4 wire, 4 x 0,34 mm <sup>2</sup> , Ø5.2 mm Oil proof PVC, grey
<b>Plug (M1)</b>	M12 x 1, 4 pin male

### Wiring

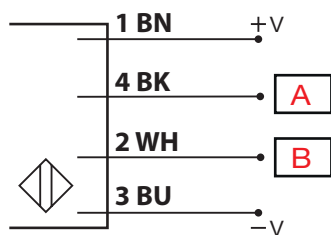

BN	BK	WH	BU	A	B
Brown	Black	White	Blue	OUT/IO-Link	IN/OUT

### Housing

<b>Body</b>	PBT,Grey, 30% glass-reinforced	
<b>Cable gland</b>	PA12, Rectangular housing	
<b>Finger nuts</b>	PA12, Rectangular housing	
<b>Trimmer shaft</b>	Nylon, Blue	
<b>Light guides</b>	Grilamid TR 55, Transparent	
<b>Dimensions</b>	M30 x 1.5	Thread
<b>Thread length</b>	45.5 mm	Non-flush
	59.5 mm	Flush
<b>Total length</b>	61 mm	Housing
<b>Weight</b>	190 g	Cable version
	106 g	Plug version



**Dimensions (mm)**

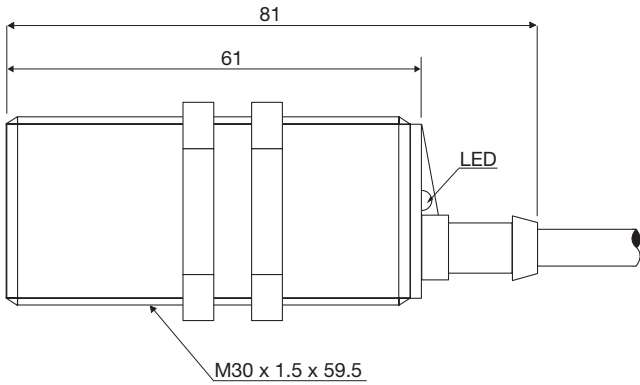

**Fig. 6 Cable CA30CAF...A2IO**

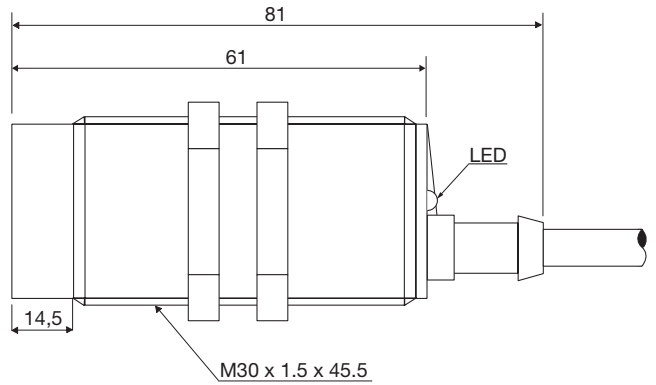

**Fig. 7 Cable CA30CAN...A2IO**

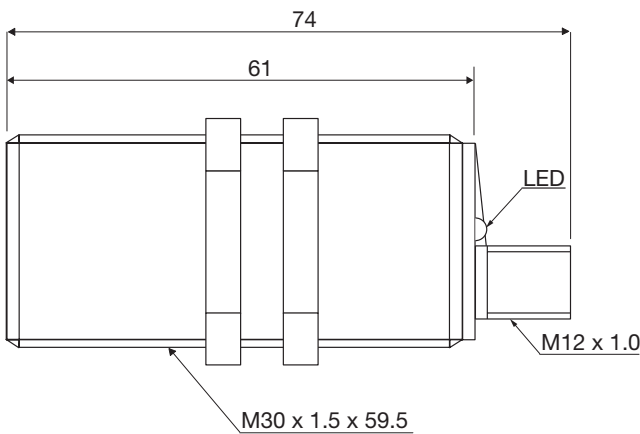

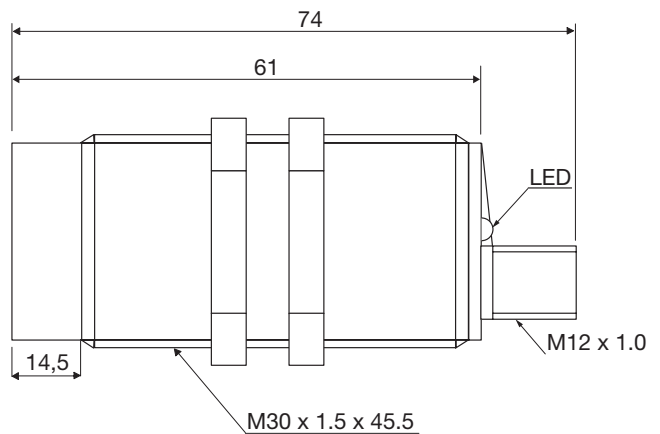

**Fig. 8 Plug CA30CAF...M1IO**



**Fig. 9 Plug CA30CAN...M1IO**

## Compatibility and conformity

### ▶ Approvals and markings

<b>General reference</b>	Sensor designed according to EN60947-5-2 and EN60947-1	
<b>MTTF<sub>d</sub></b>	98.3 years @ 40°C (+104°F)	ISO 13849-1, SN 29500
<b>CE-marking</b>		
<b>Approvals</b>		
<b>Other Approvals</b>		Topax 56, Topaz AC1, Topaz MD3, Topaz CL1, Topactiv OKTO, P3-hypochloran

### ▶ IO-Link

<b>IO-Link revision</b>	1.1
<b>Transmission rate</b>	COM2 (38.4 kbaud)
<b>SDCI-Norm</b>	IEC 61131-9
<b>Profile</b>	Smart sensor profile 2nd edition, common profile
<b>Min. cycle time</b>	5 ms
<b>SIO mode</b>	Yes
<b>Min. master port class</b>	A (4-pin)
<b>Process data length</b>	32 bit



## Delivery contents and accessories



### Delivery contents

Capacitive sensor: CA30CAxxBPxIO  
 2 x M30 finger nuts  
 Screwdriver  
 Packaging: Carton box

### Accessories

Connector type CONB14NF-... -series.  
 Mounting Brackets AMB30-S.. (straight), AMB30-A.. (angled)

### Further information

Information	Where to find it	QR
IO-Link manual	<a href="http://cga.pub/?cbfe4c">http://cga.pub/?cbfe4c</a>	
Mounting brackets	<a href="http://cga.pub/?68adbc">http://cga.pub/?68adbc</a>	
Connectors	<a href="http://cga.pub/?d839df">http://cga.pub/?d839df</a>	



COPYRIGHT ©2020  
 Content subject to change. Download the PDF: [www.gavazziautomation.com](http://www.gavazziautomation.com)