

CAT6219

500 mA CMOS LDO Regulator

Description

The CAT6219 is a 500 mA CMOS low dropout regulator that provides fast response time during load current and line voltage changes.

The quick-start feature allows the use of an external bypass capacitor to reduce the overall output noise without affecting the turn-on time of just 150 μ s.

With zero shutdown current and low ground current of 55 μ A typical, the CAT6219 is ideal for battery-operated devices with supply voltages from 2.3 V to 5.5 V. An internal under voltage lockout circuit disables the output at supply voltages under 2.15 V typical.

The CAT6219 offers 1% initial accuracy and low dropout voltage, 300 mV typical at 500 mA. Stable operation is provided with a small value ceramic capacitor, reducing required board space and component cost.

Other features include current limit and thermal protection.

The LDO is available in fixed and adjustable output in the low profile (1 mm max height) 5-lead TSOT23 and in the 6-pad 2 mm x 2 mm TDFN packages.

Features

- Guaranteed 500 mA Peak Output Current
- Low Dropout Voltage of 300 mV Typical at 500 mA
- Stable with Ceramic Output Capacitor
- External 10 nF Bypass Capacitor for Low Noise
- Quick-start Feature
- Under Voltage Lockout
- No-load Ground Current of 55 μ A Typical
- Full-load Ground Current of 85 μ A Typical
- $\pm 1.0\%$ Initial Accuracy ($V_{OUT} \geq 2.0$ V)
- $\pm 2.0\%$ Accuracy Over Temperature ($V_{OUT} \geq 2.0$ V)
- “Zero” Current Shutdown Mode
- Fold-back Current Limit
- Thermal Protection
- 5-lead TSOT-23 and 6-pad TDFN Packages
- These Devices are Pb-Free, Halogen Free/BFR Free and are RoHS Compliant

Applications

- Cellular Phones
- Battery-powered Devices
- Consumer Electronics



ON Semiconductor®

<http://onsemi.com>

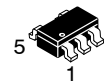

TSOT-23
TD SUFFIX
CASE 419AE



TDFN-6
VP5 SUFFIX
CASE 511AH

PIN CONNECTIONS

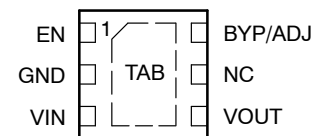
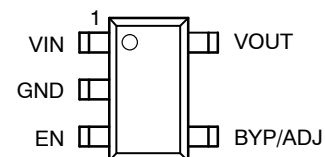

(Top View)

MARKING DIAGRAMS

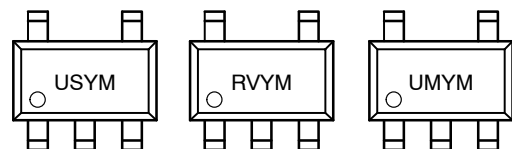

US = CAT6219-125, CAT6219-250,
CAT6219-300 Device Code

RV = CAT6219-180, CAT6219-280,
CAT6219-285, CAT6219-330 Device Code

UM = CAT6219-ADJ Device Code

Y = Production Year (last digit)

M = Production Month: 1 - 9, A, B, C

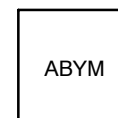

AB = CAT6219180, CAT6219VP5 Device Code

Y = Production Year (last digit)

M = Production Month: 1 - 9, A, B, C

ORDERING INFORMATION

See detailed ordering and shipping information in the package dimensions section on page 9 of this data sheet.

CAT6219

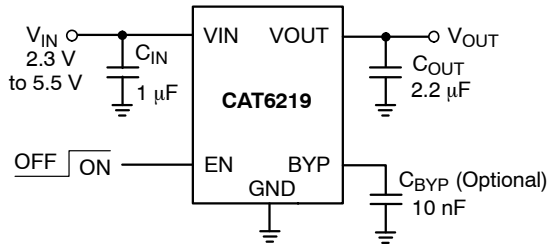

Figure 1. Typical Application Circuit

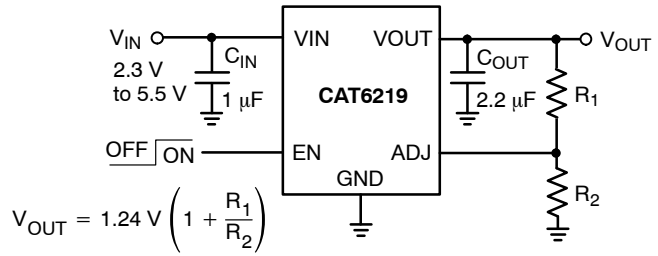

Figure 2. Adjustable Output LDO

Table 1. PIN DESCRIPTIONS

Name	Function
VIN	Supply voltage input.
GND	Ground reference.
EN	Enable input (active high); a 2.5 MΩ pull-down resistor is provided.
BYP	Optional bypass capacitor connection for noise reduction and PSRR enhancing.
ADJ	Adjustable input. Feedback pin connected to resistor divider.
VOUT	LDO Output Voltage.
TAB	To be connected to the ground plane on PCB

Pin Function

VIN is the supply pin for the LDO. A small 1 μF ceramic bypass capacitor is required between the VIN pin and ground near the device. When using longer connections to the power supply, CIN value can be increased without limit. The operating input voltage range is from 2.3 V to 5.5 V.

EN is the enable control logic (active high) for the regulator output. It has a 2.5 MΩ pull-down resistor, which assures that if EN pin is left open, the circuit is disabled.

VOUT is the LDO regulator output. A small 2.2 μF ceramic bypass capacitor is required between the VOUT pin and ground. For better transient response, its value can be increased to 4.7 μF.

The capacitor should be located near the device. For the SOT23-5 package, a continuous 500 mA output current may turn-on the thermal protection. A 250 Ω internal shutdown switch discharges the output capacitor in the no-load condition.

GND is the ground reference for the LDO. The pin must be connected to the ground plane on the PCB.

BYP is the reference bypass pin. An optional 0.01 μF capacitor can be connected between BYP pin and GND to reduce the output noise and enhance the PSRR at high frequency.

ADJ is the adjustable input pin for the adjustable LDO. The pin is connected to the resistor voltage divider.

Table 2. ABSOLUTE MAXIMUM RATINGS

Parameter	Rating	Unit
VIN	0 to 6.5	V
VEN, VOUT	-0.3 to VIN + 0.3	V
Junction Temperature, TJ	+150	°C
Power Dissipation, PD	Internally Limited (Note 1)	mW
Storage Temperature Range, TS	-65 to +150	°C
Lead Temperature (soldering, 5 sec.)	260	°C
ESD Rating (Human Body Model)	3	kV

Stresses exceeding Maximum Ratings may damage the device. Maximum Ratings are stress ratings only. Functional operation above the Recommended Operating Conditions is not implied. Extended exposure to stresses above the Recommended Operating Conditions may affect device reliability.

Table 3. RECOMMENDED OPERATING CONDITIONS (Note 2)

Parameter	Range	Unit
VIN	2.3 to 5.5	V
VEN	0 to VIN	V
Junction Temperature Range, TJ	-40 to +125	°C
Package Thermal Resistance (SOT23-5), θJA	235	°C/W

NOTE: Typical application circuit with external components is shown above.

1. The maximum allowable power dissipation at any TA (ambient temperature) is $P_{Dmax} = (T_{Jmax} - T_A)/\theta_{JA}$. Exceeding the maximum allowable power dissipation will result in excessive die temperature, and the regulator will go into thermal shutdown.
2. The device is not guaranteed to work outside its operating rating.

CAT6219

Table 4. ELECTRICAL OPERATING CHARACTERISTICS (Note 3)

($V_{IN} = V_{OUT} + 1.0$ V, $V_{EN} = \text{High}$, $I_{OUT} = 100$ μA , $C_{IN} = 1$ μF , $C_{OUT} = 2.2$ μF , ambient temperature of 25°C (over recommended operating conditions unless specified otherwise). **Bold numbers** apply for the entire junction temperature range.)

Symbol	Parameter	Conditions	Min	Typ	Max	Unit
$V_{OUT-ACC}$	Output Voltage Accuracy	Initial accuracy for $V_{OUT} \geq 2.0$ V (Note 6)	-1.0		+1.0	%
			-2.0		+2.0	
TC_{OUT}	Output Voltage Temp. Coefficient			40		ppm/°C
V_{R-LINE}	Line Regulation	$V_{IN} = V_{OUT} + 1.0$ V to 5.5 V	-0.2	± 0.1	+0.2	%/V
			-0.4		+0.4	
V_{R-LOAD}	Load Regulation	$I_{OUT} = 100$ μA to 500 mA		1	1.5	%
					2	
V_{DROP}	Dropout Voltage (Note 4)	$I_{OUT} = 500$ mA		300	400	mV
					500	
I_{GND}	Ground Current	$I_{OUT} = 0$ μA		55	75	μA
					90	
I_{GND-SD}	Shutdown Ground Current	$V_{EN} < 0.4$ V			1	μA
					2	
PSRR	Power Supply Rejection Ratio	$f = 1$ kHz, $C_{BYP} = 10$ nF		64		dB
		$f = 20$ kHz, $C_{BYP} = 10$ nF		54		
I_{SC}	Output short circuit current limit	$V_{OUT} = 0$ V		200		mA
T_{ON}	Turn-On Time	$C_{BYP} = 10$ nF		150		μs
e_N	Output Noise Voltage (Note 5)	$BW = 10$ Hz to 100 kHz		45		μV_{rms}
R_{OUT-SH}	Shutdown Switch Resistance			250		Ω
R_{EN}	Enable pull-down resistor			2.5		M Ω
V_{UVLO}	Under voltage lockout threshold			2.15		V
ESR	C_{OUT} equivalent series resistance		5		500	m Ω
V_{ADJ}	Adjustable input voltage	$I_{OUT} = 100$ μA	1.2	1.24	1.27	V

ENABLE INPUT

V_{HI}	Logic High Level	$V_{IN} = 2.3$ to 5.5 V	1.8			V
		$V_{IN} = 2.3$ to 5.5 V, 0°C to +125°C junction temperature	1.6			
V_{LO}	Logic Low Level	$V_{IN} = 2.3$ to 5.5 V			0.4	V
I_{EN}	Enable Input Current	$V_{EN} = 0.4$ V		0.15	1	μA
		$V_{EN} = V_{IN}$		1.5	4	

THERMAL PROTECTION

T_{SD}	Thermal Shutdown			160		°C
T_{HYS}	Thermal Hysteresis			10		°C

3. Specification for 2.80 V output version unless specified otherwise.
4. Dropout voltage is defined as the input-to-output differential at which the output voltage drops 2% below its nominal value measured at 1 V differential. During test, the input voltage stays always above the minimum 2.3 V.
5. Specification for 1.8 V output version.
6. For $V_{OUT} < 2.0$ V, the initial accuracy is $\pm 2\%$ and across temperature $\pm 3\%$.

CAT6219

TYPICAL CHARACTERISTICS (shown for 2.80 V output option)

($V_{IN} = 3.85\text{ V}$, $I_{OUT} = 100\ \mu\text{A}$, $C_{IN} = 1\ \mu\text{F}$, $C_{OUT} = 2.2\ \mu\text{F}$, $C_{BYP} = 10\ \text{nF}$, $T_A = 25^\circ\text{C}$ unless otherwise specified.)

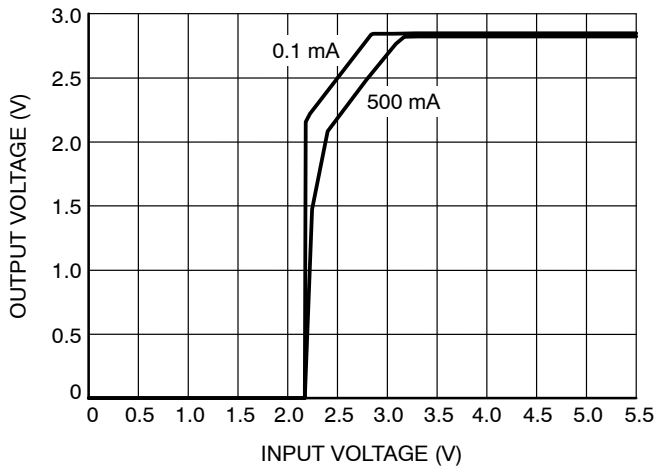

Figure 3. Dropout Characteristics

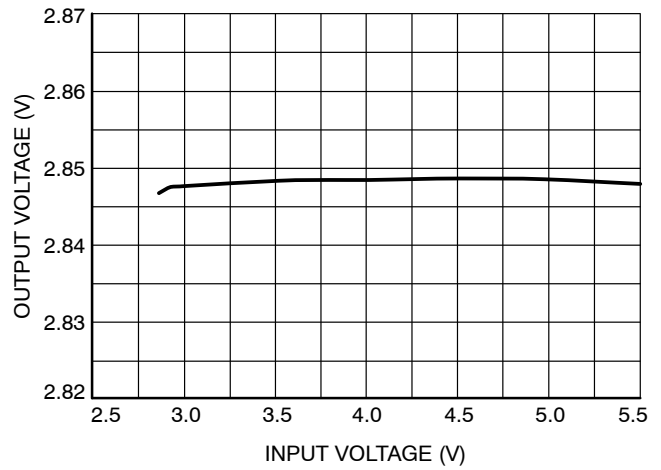

Figure 4. Line Regulation

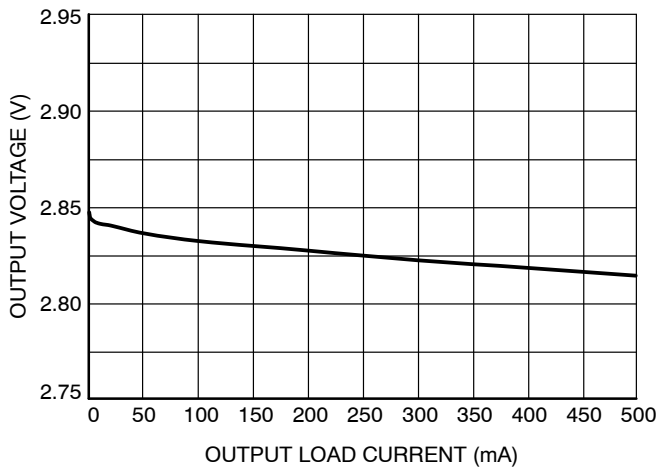

Figure 5. Load Regulation

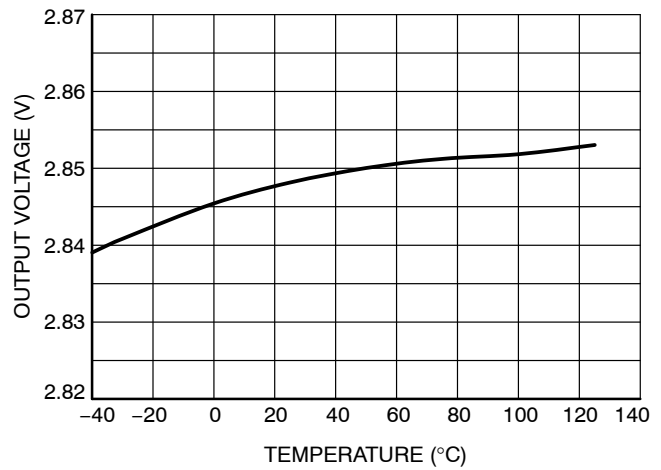

Figure 6. Output Voltage vs. Temperature

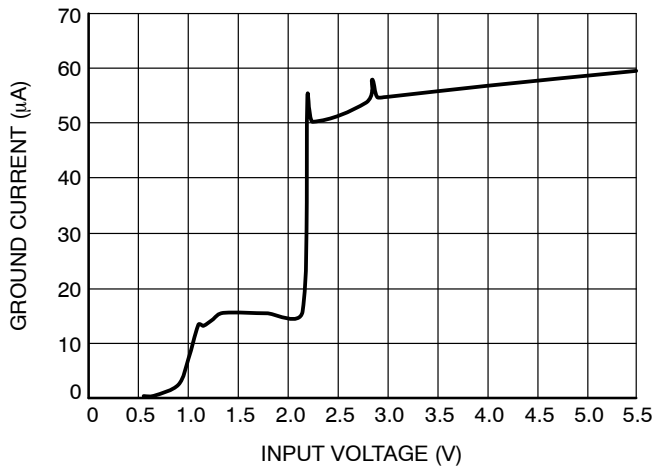

Figure 7. Ground Current vs. Input Voltage

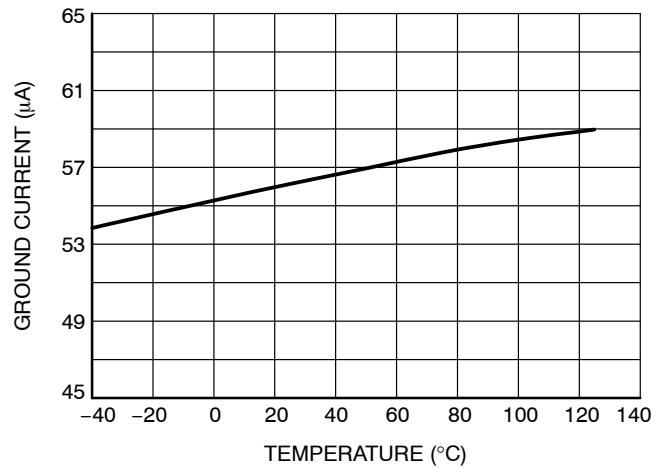

Figure 8. Ground Current vs. Temperature

CAT6219

TYPICAL CHARACTERISTICS (shown for 2.80 V output option)

($V_{IN} = 3.85\text{ V}$, $I_{OUT} = 100\ \mu\text{A}$, $C_{IN} = 1\ \mu\text{F}$, $C_{OUT} = 2.2\ \mu\text{F}$, $C_{BYP} = 10\ \text{nF}$, $T_A = 25^\circ\text{C}$ unless otherwise specified.)

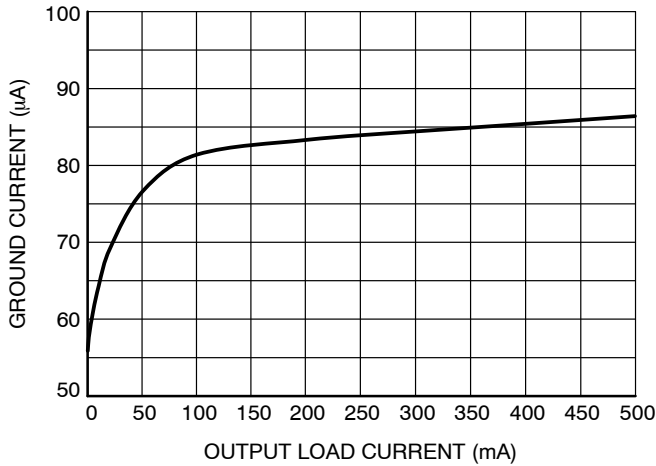

Figure 9. Ground Current vs. Load Current

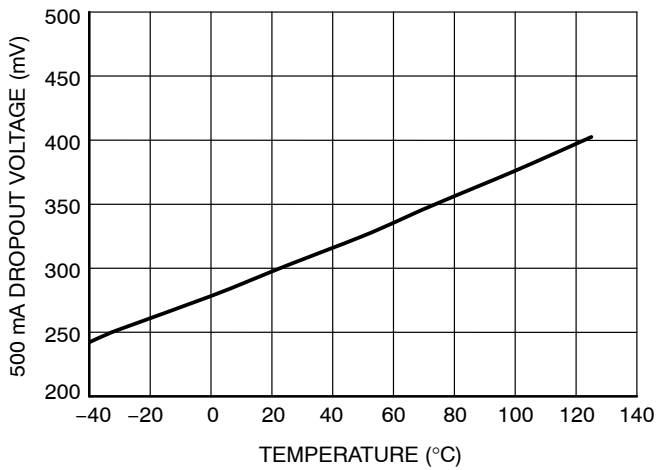

Figure 10. Dropout vs. Temperature (500 mA Load)

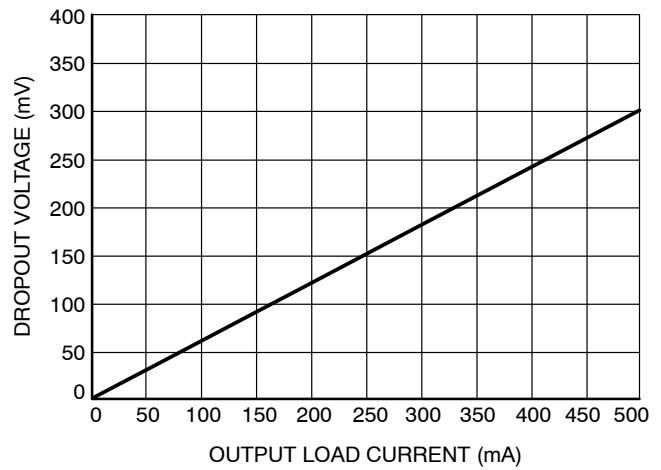

Figure 11. Dropout vs. Load Current

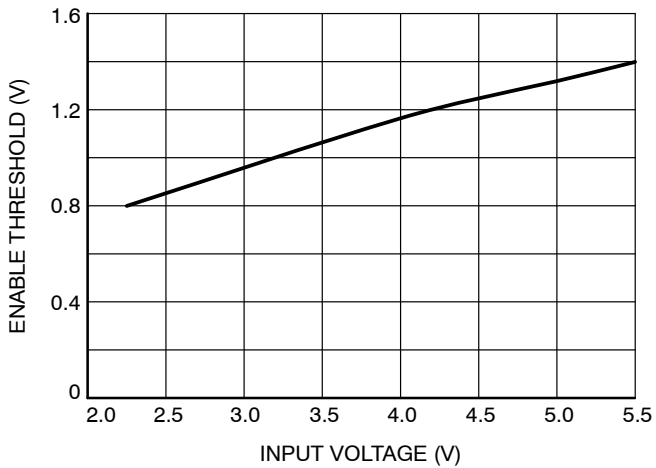

Figure 12. Enable Threshold vs. Input Voltage

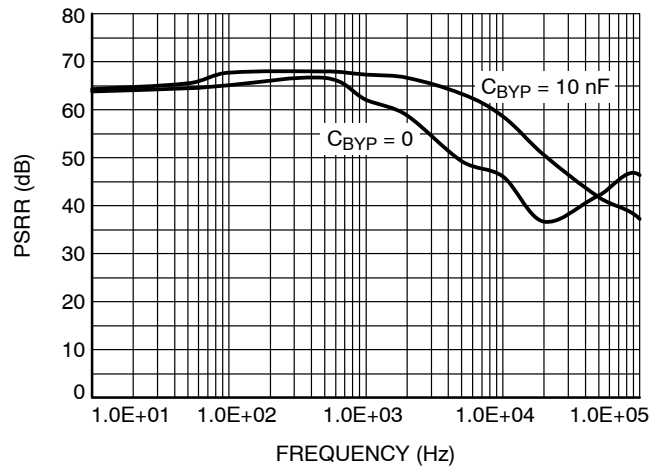

Figure 13. PSRR vs. Frequency (10 mA Load)

TRANSIENT CHARACTERISTICS (shown for 2.80 V output option)

($V_{IN} = 3.85\text{ V}$, $I_{OUT} = 100\ \mu\text{A}$, $C_{IN} = 1\ \mu\text{F}$, $C_{OUT} = 2.2\ \mu\text{F}$, $C_{BYP} = 10\ \text{nF}$, $T_A = 25^\circ\text{C}$ unless otherwise specified.)

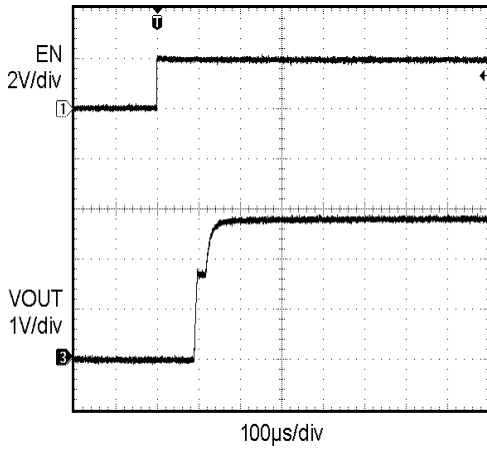

Figure 14. Enable Turn-on (100 μA Load)

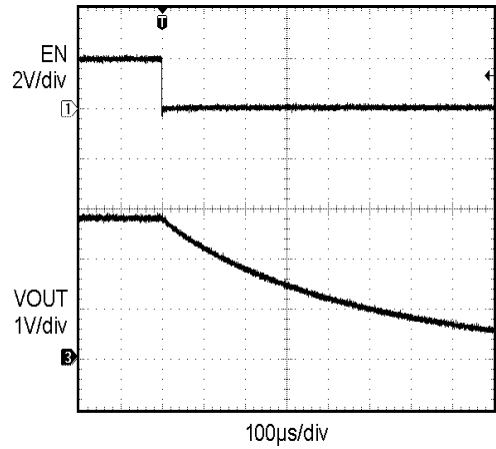

Figure 15. Enable Turn-off (100 μA Load)

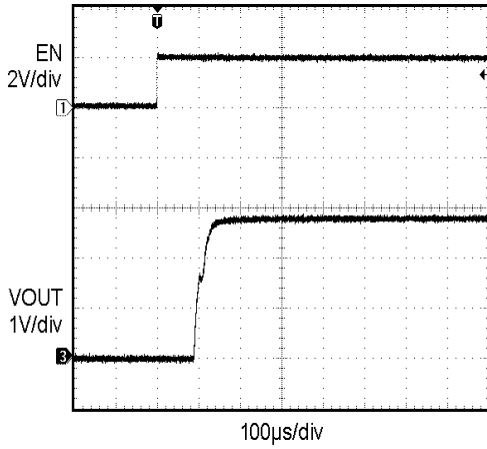

Figure 16. Enable Turn-on (500 mA Load)

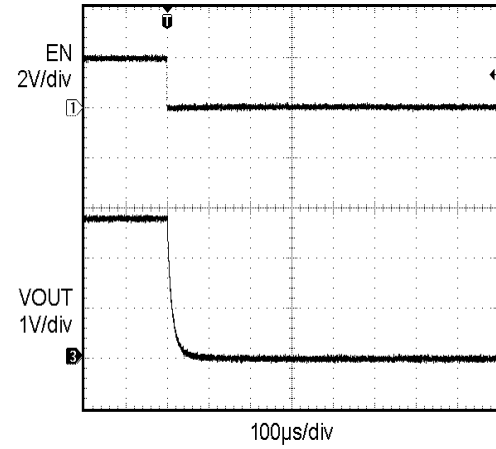

Figure 17. Enable Turn-off (500 mA Load)

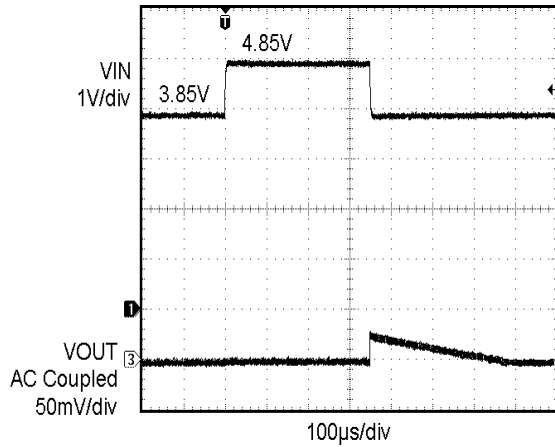

Figure 18. Line Transient Response (3.85 V to 4.85 V)

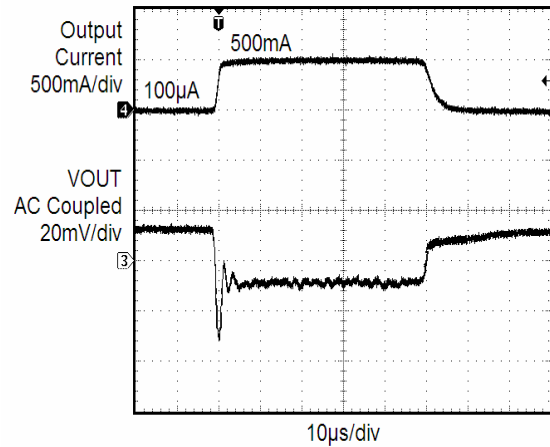
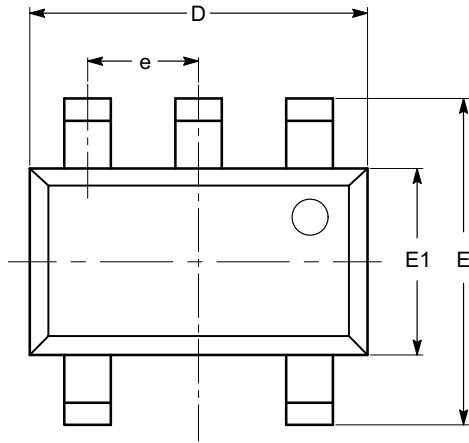

Figure 19. Load Transient Response (0.1 mA to 500 mA)

CAT6219

PACKAGE DIMENSIONS

TSOT-23, 5 LEAD
CASE 419AE-01
ISSUE O



TOP VIEW

SYMBOL	MIN	NOM	MAX
A			1.00
A1	0.01	0.05	0.10
A2	0.80	0.87	0.90
b	0.30		0.45
c	0.12	0.15	0.20
D	2.90 BSC		
E	2.80 BSC		
E1	1.60 BSC		
e	0.95 TYP		
L	0.30	0.40	0.50
L1	0.60 REF		
L2	0.25 BSC		
θ	0°		8°

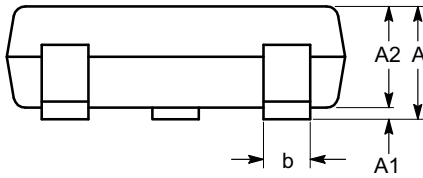

SIDE VIEW

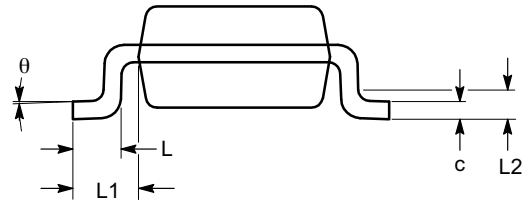

END VIEW

Notes:

- (1) All dimensions are in millimeters. Angles in degrees.
- (2) Complies with JEDEC MO-193.

CAT6219

PACKAGE DIMENSIONS

TDFN6, 2x2
CASE 511AH-01
ISSUE A

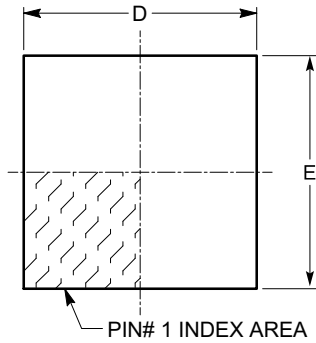

TOP VIEW

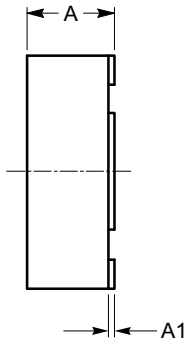

SIDE VIEW

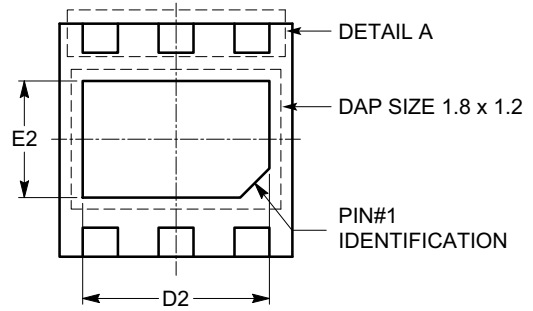

BOTTOM VIEW

SYMBOL	MIN	NOM	MAX
A	0.70	0.75	0.80
A1	0.00	0.02	0.05
A3	0.20 REF		
b	0.25	0.30	0.35
D	1.90	2.00	2.10
D2	1.50	1.60	1.70
E	1.90	2.00	2.10
E2	0.90	1.00	1.10
e	0.65 TYP		
L	0.15	0.25	0.35

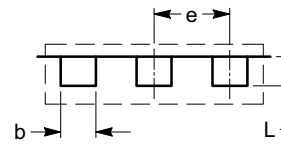

DETAIL A

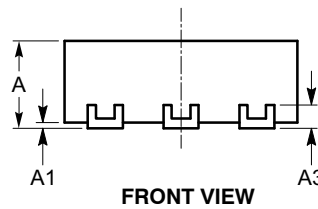

FRONT VIEW

Notes:

- (1) All dimensions are in millimeters.
- (2) Complies with JEDEC standard MO-229.

CAT6219

Example of Ordering Information (Note 9)

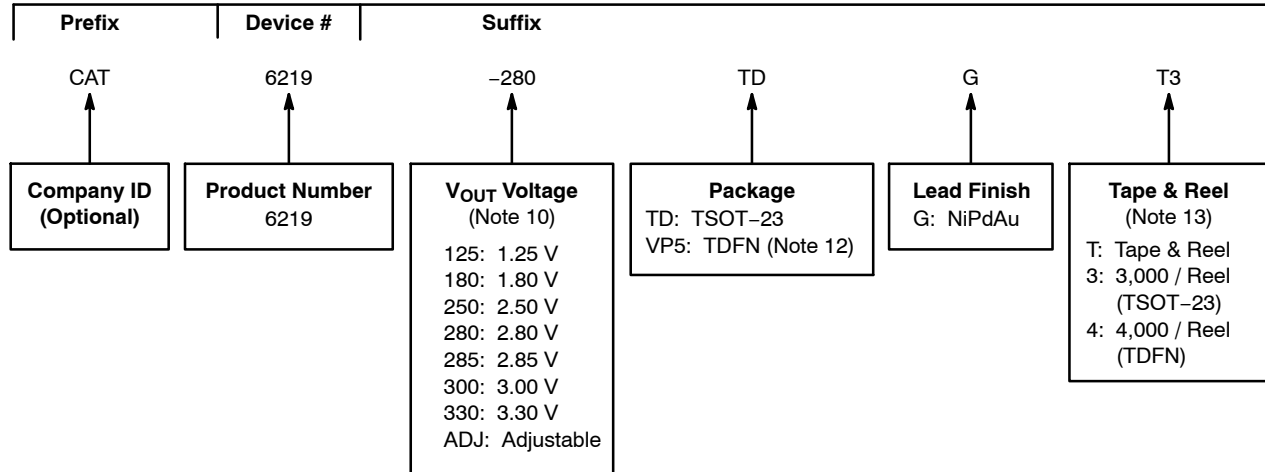

ORDERING INFORMATION

Orderable Part Number	V _{OUT} Voltage	Package	Shipping
CAT6219-125TDGT3	1.25 V	TSOT-23-5	3,000 / Tape & Reel
CAT6219-180TDGT3	1.80 V	TSOT-23-5	3,000 / Tape & Reel
CAT6219-250TDGT3	2.50 V	TSOT-23-5	3,000 / Tape & Reel
CAT6219-280TDGT3	2.80 V	TSOT-23-5	3,000 / Tape & Reel
CAT6219-285TDGT3 (Note 10)	2.85 V	TSOT-23-5	3,000 / Tape & Reel
CAT6219-300TDGT3	3.00 V	TSOT-23-5	3,000 / Tape & Reel
CAT6219-330TDGT3	3.30 V	TSOT-23-5	3,000 / Tape & Reel
CAT6219ADJTD-GT3	1.25 V to 5 V	TSOT-23-5	3,000 / Tape & Reel
CAT6219180VP5GT4 (Note 11)	1.80 V	TDFN-6	4,000 / Tape & Reel
CAT6219VP5330GT4 (Note 11)	3.30 V	TDFN-6	4,000 / Tape & Reel
CAT6219ADJVP5GT4 (Note 11)	1.25 V to 5 V	TDFN-6	4,000 / Tape & Reel

7. All packages are RoHS-compliant (Lead-free, Halogen-free).
8. The standard lead finish is NiPdAu pre-plated (PPF) lead frames.
9. The device used in the above example is a CAT6219-280TDGT3 (V_{OUT} = 2.8 V, in a TSOT-23 package, NiPdAu, Tape & Reel, 3,000/Reel).
10. For other voltage options, please contact your nearest ON Semiconductor Sales office.
11. Part number is not exactly the same as the "Example of Ordering Information" shown above. For indicated part numbers there are NO hyphens in the orderable part numbers.
12. Contact factory for availability.
13. For information on tape and reel specifications, including part orientation and tape sizes, please refer to our Tape and Reel Packaging Specifications Brochure, BRD8011/D.

ON Semiconductor and  are registered trademarks of Semiconductor Components Industries, LLC (SCILLC). SCILLC reserves the right to make changes without further notice to any products herein. SCILLC makes no warranty, representation or guarantee regarding the suitability of its products for any particular purpose, nor does SCILLC assume any liability arising out of the application or use of any product or circuit, and specifically disclaims any and all liability, including without limitation special, consequential or incidental damages. "Typical" parameters which may be provided in SCILLC data sheets and/or specifications can and do vary in different applications and actual performance may vary over time. All operating parameters, including "Typicals" must be validated for each customer application by customer's technical experts. SCILLC does not convey any license under its patent rights nor the rights of others. SCILLC products are not designed, intended, or authorized for use as components in systems intended for surgical implant into the body, or other applications intended to support or sustain life, or for any other application in which the failure of the SCILLC product could create a situation where personal injury or death may occur. Should Buyer purchase or use SCILLC products for any such unintended or unauthorized application, Buyer shall indemnify and hold SCILLC and its officers, employees, subsidiaries, affiliates, and distributors harmless against all claims, costs, damages, and expenses, and reasonable attorney fees arising out of, directly or indirectly, any claim of personal injury or death associated with such unintended or unauthorized use, even if such claim alleges that SCILLC was negligent regarding the design or manufacture of the part. SCILLC is an Equal Opportunity/Affirmative Action Employer. This literature is subject to all applicable copyright laws and is not for resale in any manner.

PUBLICATION ORDERING INFORMATION

LITERATURE FULFILLMENT:
Literature Distribution Center for ON Semiconductor
P.O. Box 5163, Denver, Colorado 80217 USA
Phone: 303-675-2175 or 800-344-3860 Toll Free USA/Canada
Fax: 303-675-2176 or 800-344-3867 Toll Free USA/Canada
Email: orderlit@onsemi.com

N. American Technical Support: 800-282-9855 Toll Free
USA/Canada
Europe, Middle East and Africa Technical Support:
Phone: 421 33 790 2910
Japan Customer Focus Center
Phone: 81-3-5773-3850

ON Semiconductor Website: www.onsemi.com
Order Literature: <http://www.onsemi.com/orderlit>

For additional information, please contact your local Sales Representative