

CAT6221

300 mA CMOS Dual LDO Regulator

Description

The 300 mA CMOS Dual LDO CAT6221 combines in a single TSOT-23 6-lead package two low dropout regulators (LDO), each with its own enable pin.

The regulator outputs drive loads up to 300 mA. By design, the dual LDO provides fast response time during load current and line voltage changes.

Each LDO is optimized for low noise and high crosstalk isolation. With zero shut down current and a low quiescent current of 100 μ A, the dual LDO is ideal for battery-operated devices with supply voltage from 2.3 V to 5.5 V.

The dual LDO offers 1% initial accuracy and very low dropout voltage, typical 210 mV at 300 mA. Stable operation is provided with small 1 μ F ceramic output capacitors, reducing required board space and component cost.

Other features include fold-back current limit and thermal protection.

The dual LDO is available in the tiny 6-lead TSOT-23 package with a maximum height of 0.8 mm.

Features

- Two Outputs with Guaranteed 300 mA Peak Output Current
- Low Dropout Voltages of 210 mV Typical at 300 mA
- Stable with Ceramic Output Capacitors
- Independent Enable Pins
- Under Voltage Lockout
- No-load Ground Current of 100 μ A Typical
- Full-load Ground Current of 160 μ A Typical
- $\pm 1.0\%$ Output Voltage Initial Accuracy ($V_{OUT} \geq 2.0$ V)
- $\pm 2.0\%$ Accuracy Over Temperature ($V_{OUT} \geq 2.0$ V)
- “Zero” Current Shutdown Mode
- Fold-back Current Limit and Thermal Protection
- TSOT-23 6-lead, 0.8 mm Height Package
- These Devices are Pb-Free, Halogen Free/BFR Free and are RoHS Compliant

Applications

- Cellular Phones
- Battery-powered Devices
- Consumer Electronics



ON Semiconductor®

<http://onsemi.com>



TSOT-23
TD SUFFIX
CASE 419AF

PIN CONNECTIONS

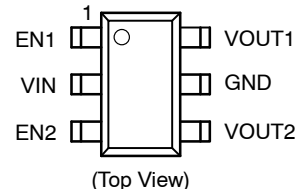

MARKING DIAGRAM

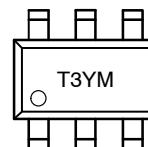

T3 = CAT6221 Device Code
Y = Production Year (last digit)
M = Production Month: 1 – 9, A, B, C

PIN FUNCTION

Pin #	Name	Function
1	EN1	Enable input (active high) for VOUT1.
2	VIN	Supply voltage input.
3	EN2	Enable input (active high) for VOUT2.
4	VOUT2	LDO Output Voltage 2.
5	GND	Ground reference.
6	VOUT1	LDO Output Voltage 1.

ORDERING INFORMATION

See detailed ordering and shipping information in the package dimensions section on page 10 of this data sheet.

CAT6221

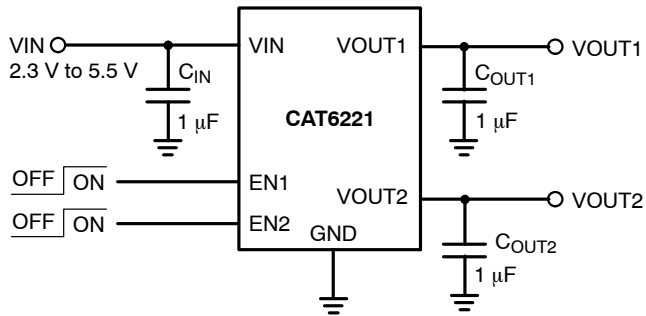

Figure 1. Typical Application Circuit

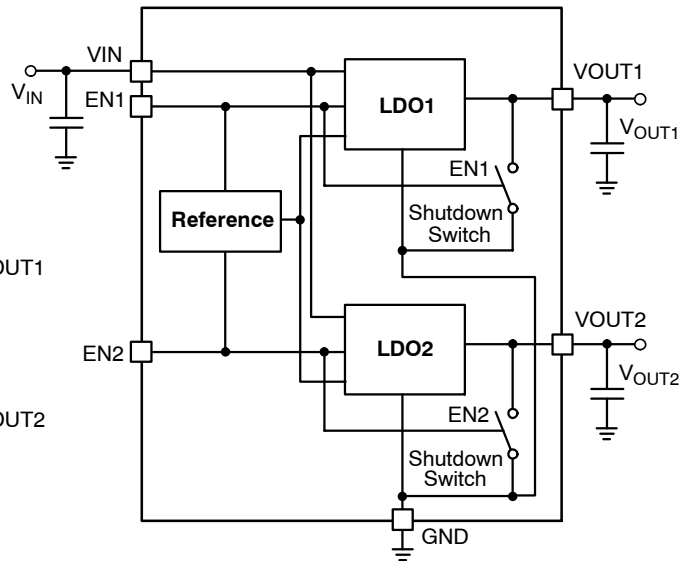

Figure 2. CAT6221 Functional Block Diagram

Pin Function

VIN is the supply pin for the LDO. A small 1 μF ceramic bypass capacitor is required between the VIN pin and ground near the device. When using longer connections to the power supply, CIN value can be increased without limit. The operating input voltage range is from 2.3 V to 5.5 V.

EN1 & 2 are the enable control logic (active high) for the regulator outputs.

VOUT1 & 2 are the LDO regulator outputs. A small 1 μF ceramic bypass capacitor is required between the VOUT

pins and ground. For better transient response, its value can be increased to 4.7 μF.

The capacitor should be located near the device. For the TSOT23 6-lead package, a continuous 300 mA output current for both LDOs may turn-on the thermal protection.

On each output, a 250 Ω internal shutdown switch discharges the output capacitor in the no-load condition.

GND is the ground reference for the LDO. The pin must be connected to the ground plane on the PCB.

Table 1. ABSOLUTE MAXIMUM RATINGS

Parameter	Rating	Unit
VIN	0 to 6.5	V
VEN, VOUT	-0.3 to VIN + 0.3	V
Junction Temperature, TJ	+150	°C
Power Dissipation, PD	Internally Limited (Note 1)	mW
Storage Temperature Range, TS	-65 to +150	°C
Lead Temperature (soldering, 5 sec.)	260	°C
ESD Rating (Human Body Model)	3	kV

Stresses exceeding Maximum Ratings may damage the device. Maximum Ratings are stress ratings only. Functional operation above the Recommended Operating Conditions is not implied. Extended exposure to stresses above the Recommended Operating Conditions may affect device reliability.

Table 2. RECOMMENDED OPERATING CONDITIONS (Note 2)

Parameter	Range	Unit
VIN	2.3 to 5.5	V
VEN	0 to VIN	V
Junction Temperature Range, TJ	-40 to +125	°C
Package Thermal Resistance (TSOT23), θJA	235	°C/W

NOTE: Typical application circuit with external components is shown above.

1. The maximum allowable power dissipation at any TA (ambient temperature) is $P_{Dmax} = (T_{Jmax} - T_A)/\theta_{JA}$. Exceeding the maximum allowable power dissipation will result in excessive die temperature, and the regulator will go into thermal shutdown.
2. The device is not guaranteed to work outside its operating rating.

CAT6221

Table 3. ELECTRICAL OPERATING CHARACTERISTICS (Note 3)

($V_{IN} = V_{OUT} + 1.0$ V, $V_{EN} = \text{High}$, $I_{OUT} = 100$ μA , $C_{IN} = C_{OUT} = 1$ μF , ambient temperature of 25°C (over recommended operating conditions unless specified otherwise). **Bold numbers** apply for the entire junction temperature range.)

Symbol	Parameter	Conditions	Min	Typ	Max	Unit
$V_{OUT-ACC}$	Output Voltage Accuracy	Initial accuracy (Note 4)	-1.0		+1.0	%
			-2.0		+2.0	
TC_{OUT}	Output Voltage Temp. Coefficient			40		ppm/°C
V_{R-LINE}	Line Regulation	$V_{IN} = V_{OUT} + 1.0$ V to 5.5 V	-0.2	± 0.1	+0.2	%/V
			-0.4		+0.4	
V_{R-LOAD}	Load Regulation	$I_{OUT} = 100$ μA to 300 mA		0.9	1.5	%
					2	
V_{DROP}	Dropout Voltage (Note 5)	$I_{OUT} = 300$ mA		210	280	mV
					350	
I_{GND}	Ground Current	Both LDOs Enabled $I_{OUT} = 0$ μA		100	140	μA
					170	
		One LDO Enabled $I_{OUT} = 0$ μA		160		
				55	75	
	One LDO Enabled $I_{OUT} = 300$ mA		85			
I_{GND-SD}	Shutdown Ground Current	$V_{EN} < 0.4$ V			2	μA
					4	
PSRR	Power Supply Rejection Ratio	$f = 1$ kHz		60		dB
		$f = 20$ kHz		45		
I_{SC}	Output short circuit current limit	$V_{OUT} = 0$ V		130		mA
T_{ON}	Turn-On Time			150		μs
e_N	Output Noise Voltage (Note 6)	BW = 10 Hz to 100 kHz		95		μV_{rms}
R_{OUT-SH}	Shutdown Switch Resistance			250		Ω
$V_{IN-UVLO}$	Under voltage lockout threshold			2.15		V
ESR	C_{OUT} equivalent series resistance		5		500	m Ω

ENABLE INPUT (EN1, EN2)

V_{HI}	Logic High Level	$V_{IN} = 2.3$ to 5.5 V	1.8			V
V_{LO}	Logic Low Level	$V_{IN} = 2.3$ to 5.5 V			0.4	V
I_{EN}	Enable Input Current	$V_{EN} = 0.4$ V		0.05	1	μA
		$V_{EN} = V_{IN}$		0.1	1	

THERMAL PROTECTION

T_{SD}	Thermal Shutdown			160		°C
T_{HYS}	Thermal Hysteresis			10		°C

3. Specification for 2.8 V output version unless specified otherwise.
4. For $V_{OUT} < 2.0$ V, the initial accuracy is $\pm 2\%$ and across temp is $\pm 3\%$.
5. Dropout voltage is defined as the input-to-output differential at which the output voltage drops 2% below its nominal value measured at 1 V differential. During test, the input voltage stays always above the minimum 2.3 V.
6. Specification for 1.8 V output version.

CAT6221

TYPICAL CHARACTERISTICS (shown for 2.8 V/1.8 V outputs option)

($V_{IN} = 3.8\text{ V}$, $I_{OUT} = 100\ \mu\text{A}$, $EN1 = EN2 = V_{IN}$, $C_{IN} = C_{OUT} = 1\ \mu\text{F}$, $T_A = 25^\circ\text{C}$ unless otherwise specified.)

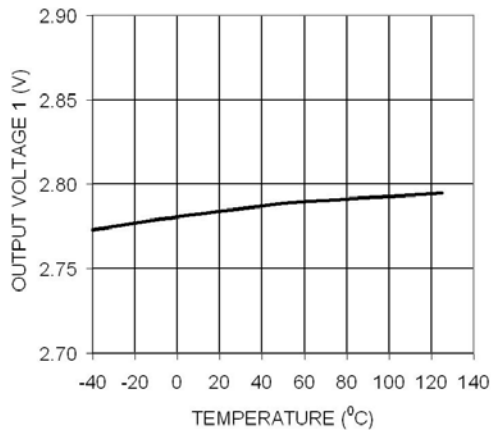

Figure 3. Output Voltage 1 vs. Temperature

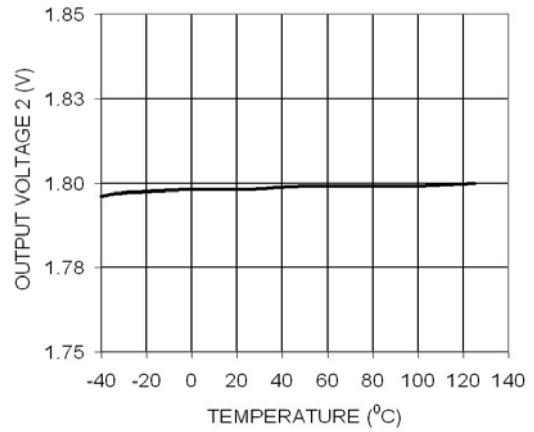

Figure 4. Output Voltage 2 vs. Temperature

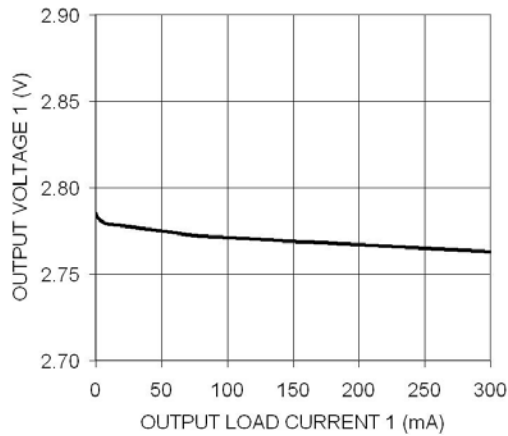

Figure 5. Load Regulation VOUT1

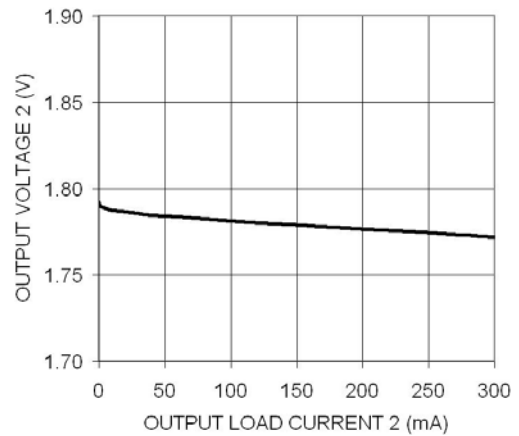

Figure 6. Load Regulation VOUT2

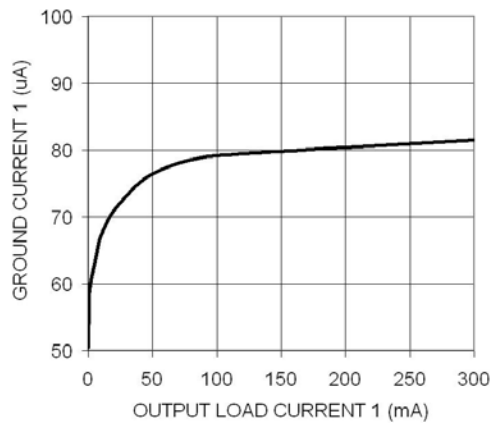

Figure 7. Ground Current (EN2 = GND)

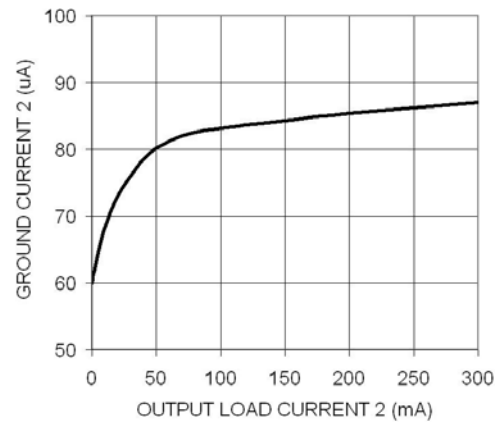

Figure 8. Ground Current (EN1 = GND)

CAT6221

TYPICAL CHARACTERISTICS (shown for 2.8 V/1.8 V outputs option)

($V_{IN} = 3.8\text{ V}$, $I_{OUT} = 100\ \mu\text{A}$, $EN1 = EN2 = V_{IN}$, $C_{IN} = C_{OUT} = 1\ \mu\text{F}$, $T_A = 25^\circ\text{C}$ unless otherwise specified.)

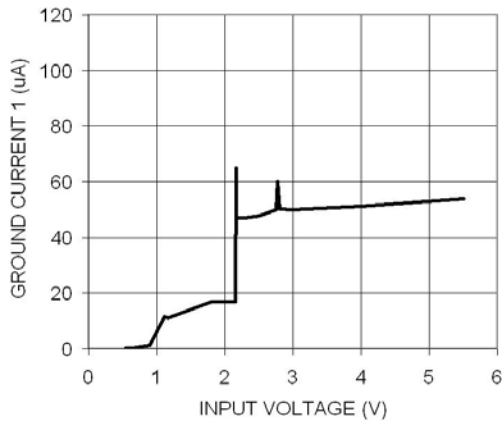

Figure 9. Ground Current (EN2 = GND)

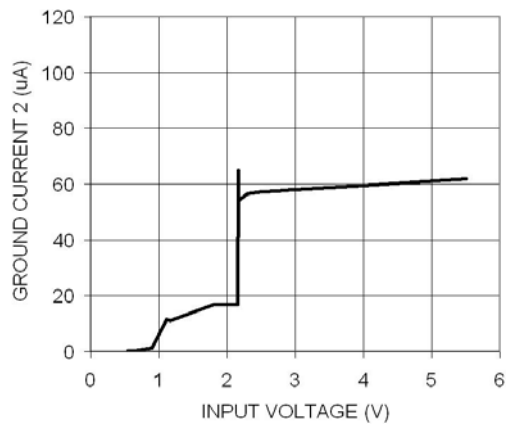

Figure 10. Ground Current (EN1 = GND)

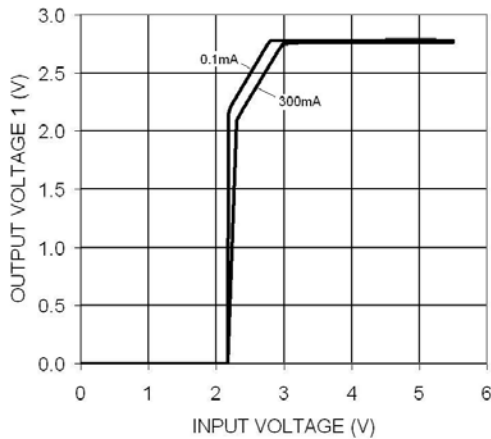

Figure 11. Output 1 Dropout Characteristics

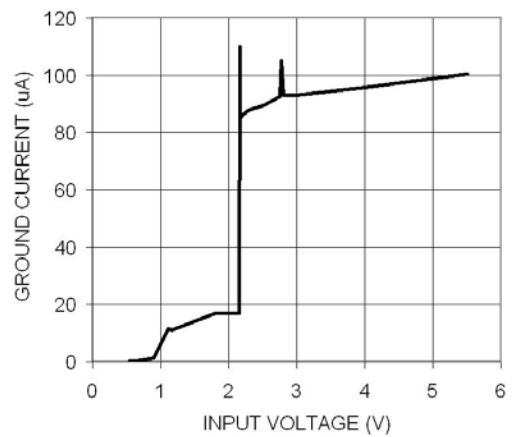

Figure 12. Ground Current vs. Input Voltage

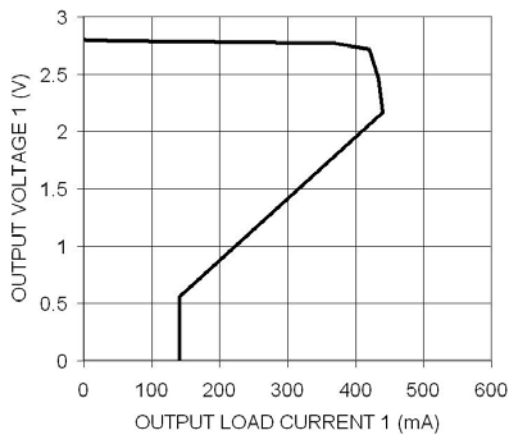

Figure 13. Output Voltage 1 vs. Load Current 1

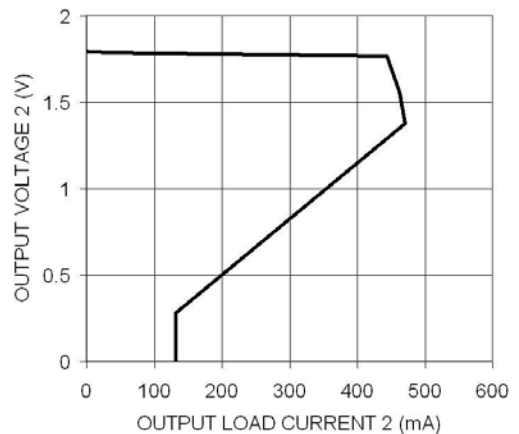

Figure 14. Output Voltage 2 vs. Load Current 2

CAT6221

TYPICAL CHARACTERISTICS (shown for 2.8 V/1.8 V outputs option)

($V_{IN} = 3.8\text{ V}$, $I_{OUT} = 100\ \mu\text{A}$, $EN1 = EN2 = V_{IN}$, $C_{IN} = C_{OUT} = 1\ \mu\text{F}$, $T_A = 25^\circ\text{C}$ unless otherwise specified.)

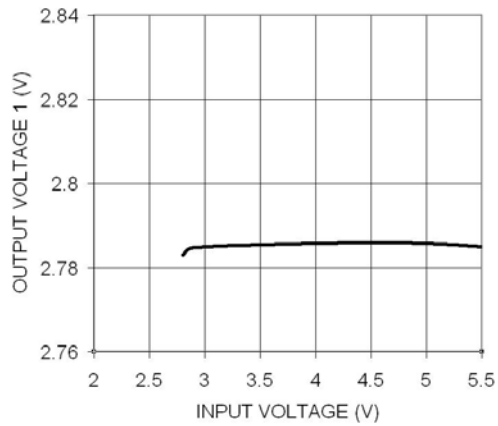

Figure 15. Line Regulation VOUT1

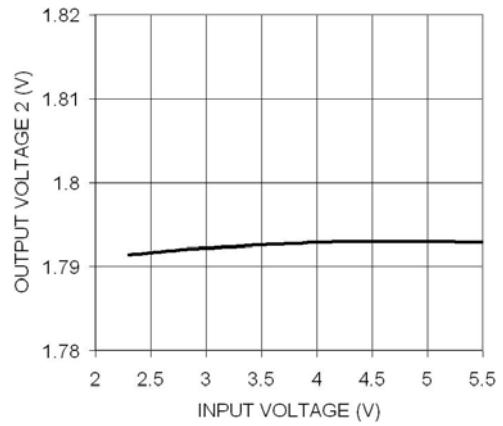

Figure 16. Line Regulation VOUT2

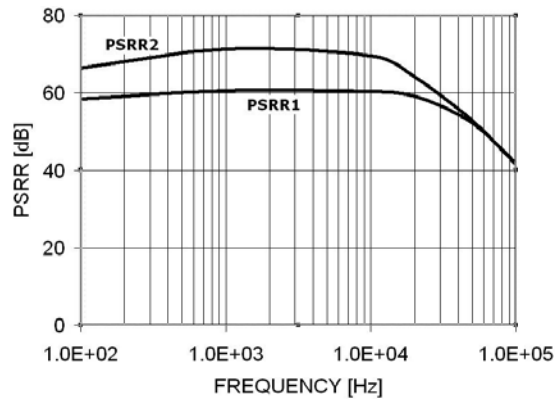

Figure 17. PSRR 1 & 2 vs. Frequency
(30 mA Load)

CAT6221

TRANSIENT CHARACTERISTICS (shown for 2.8 V/1.8 V outputs option)

($V_{IN} = 3.8\text{ V}$, $I_{OUT} = 100\ \mu\text{A}$, $EN1 = EN2 = V_{IN}$, $C_{IN} = C_{OUT} = 1\ \mu\text{F}$, $T_A = 25^\circ\text{C}$ unless otherwise specified.)

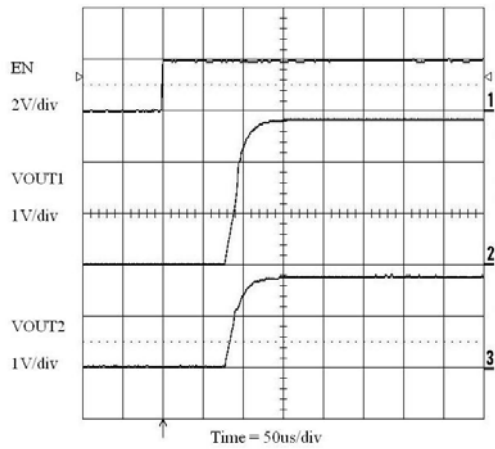

Figure 18. Enable Turn-on (100 μA Loads)

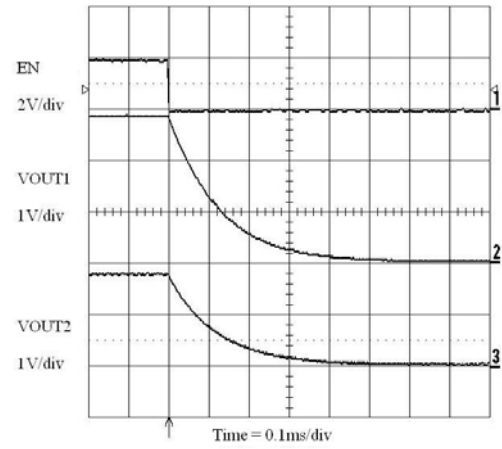

Figure 19. Enable Turn-off (100 μA Loads)

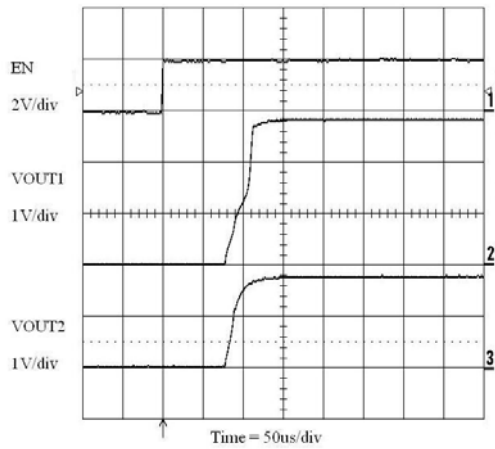

Figure 20. Enable Turn-on
(300 mA/100 μA Loads)

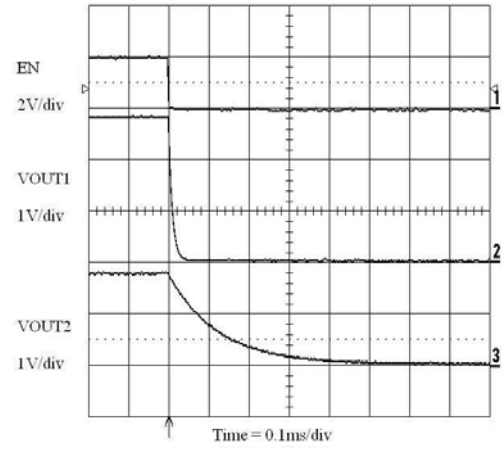

Figure 21. Enable Turn-off
(300 mA/100 μA Loads)

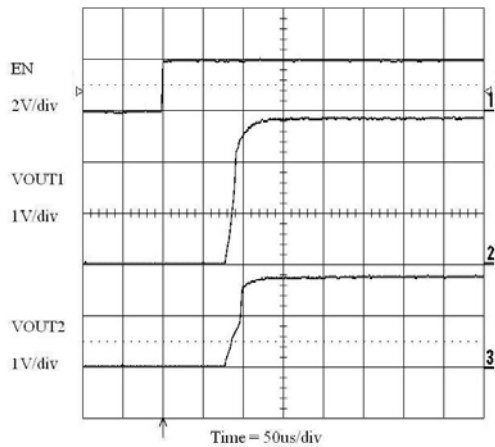

Figure 22. Enable Turn-on
(100 μA /300 mA Loads)

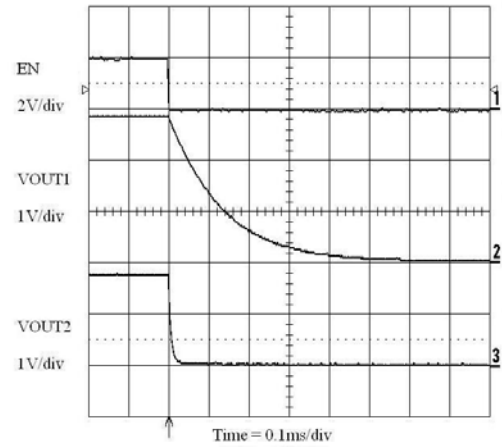

Figure 23. Enable Turn-off
(100 μA /300 mA Loads)

NOTE: All transient characteristics are generated using the evaluation board CAT621XEVAL1.

CAT6221

TRANSIENT CHARACTERISTICS (shown for 2.8 V/1.8 V outputs option)

($V_{IN} = 3.8\text{ V}$, $I_{OUT} = 100\ \mu\text{A}$, $EN1 = EN2 = V_{IN}$, $C_{IN} = C_{OUT} = 1\ \mu\text{F}$, $T_A = 25^\circ\text{C}$ unless otherwise specified.)

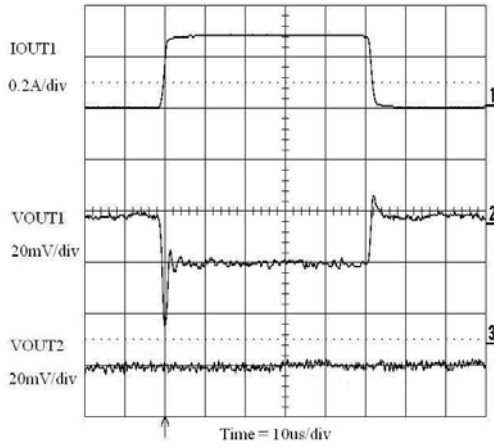

Figure 24. VOUT1 Load Transient Response (0.1 to 300 mA)

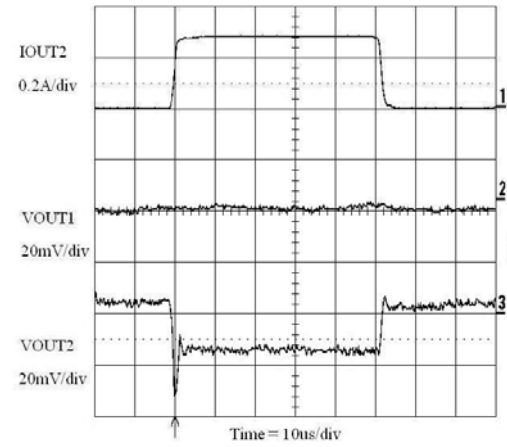

Figure 25. VOUT2 Load Transient Response (0.1 to 300 mA)

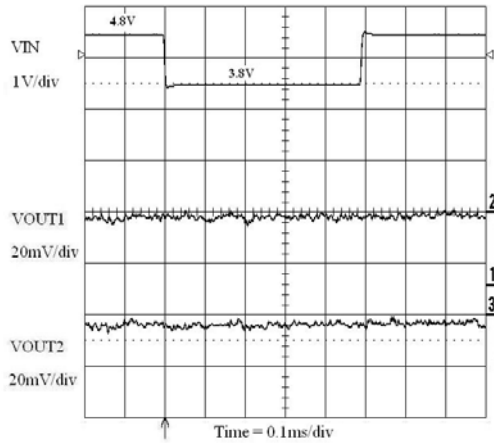

Figure 26. Line Transient Response (0.1 mA Loads)

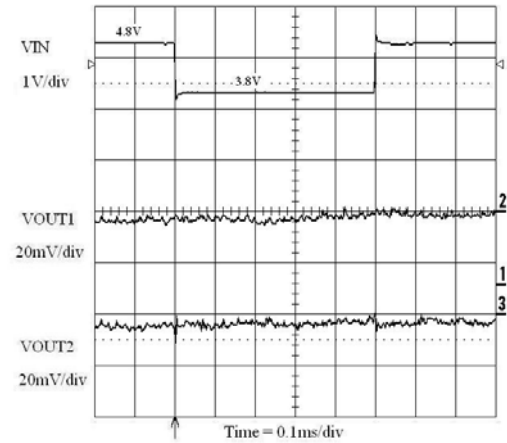

Figure 27. Line Transient Response (0.1/100 mA Loads)

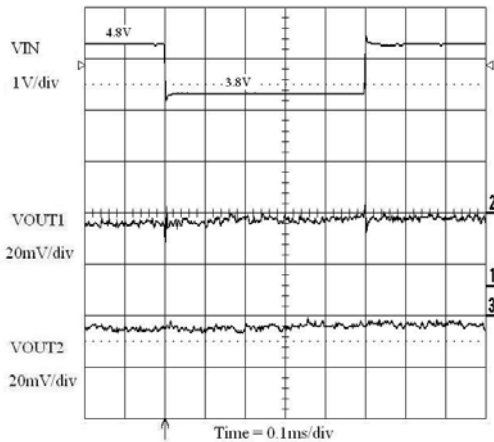

Figure 28. Line Transient Response (100/0.1 mA Loads)

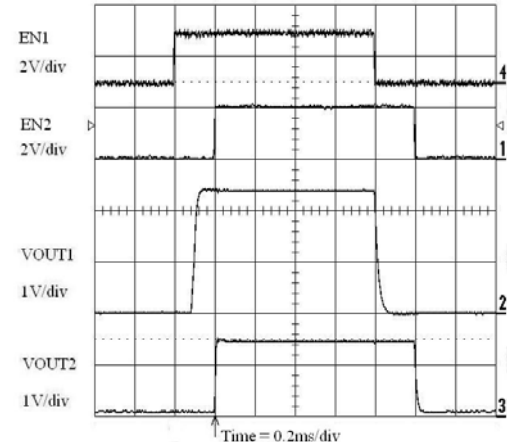

Figure 29. Separate Enable Operation (100 mA Loads)

NOTE: All transient characteristics are generated using the evaluation board CAT621XEVAL1.

CAT6221

PACKAGE DIMENSIONS

TSOT-23, 6 LEAD
CASE 419AF-01
ISSUE O

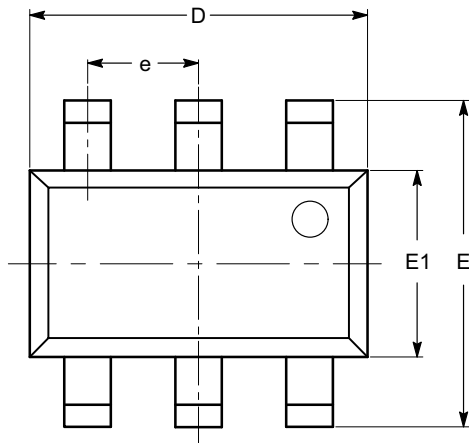

TOP VIEW

SYMBOL	MIN	NOM	MAX
A			1.00
A1	0.01	0.05	0.10
A2	0.80	0.87	0.90
b	0.30		0.45
c	0.12	0.15	0.20
D	2.90 BSC		
E	2.80 BSC		
E1	1.60 BSC		
e	0.95 TYP		
L	0.30	0.40	0.50
L1	0.60 REF		
L2	0.25 BSC		
θ	0°		8°

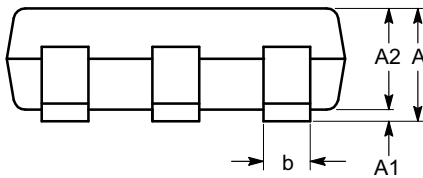

SIDE VIEW

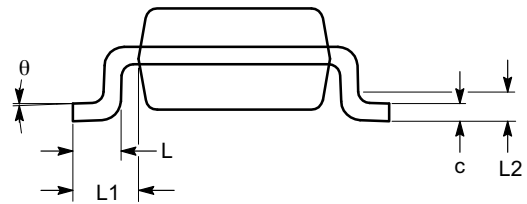

END VIEW

Notes:

- (1) All dimensions are in millimeters. Angles in degrees.
- (2) Complies with JEDEC MO-193.

CAT6221

Example of Ordering Information (Note 9)

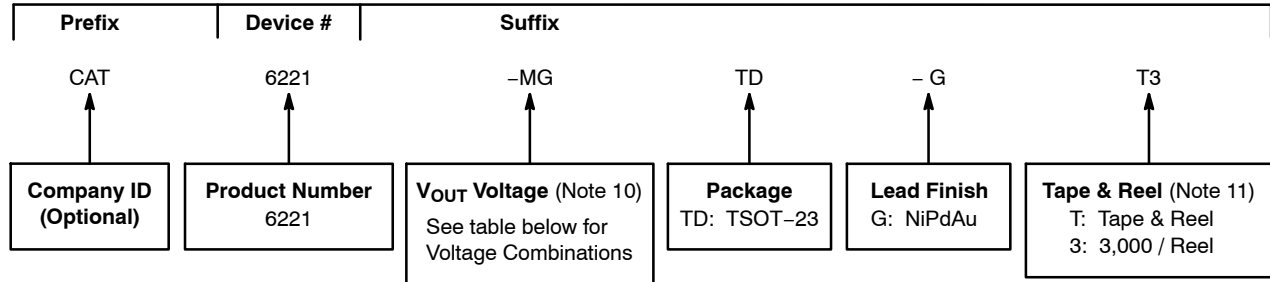

ORDERING INFORMATION

Orderable Part Number	V _{OUT} Voltage V _{OUT1} / V _{OUT2}	Package	Shipping
CAT6221-JFTD-GT3	2.5 V / 1.5 V	TSOT-23	3,000 / Tape & Reel
CAT6221-JGTD-GT3	2.5 V / 1.8 V	TSOT-23	3,000 / Tape & Reel
CAT6221-JLTD-GT3	2.5 V / 2.7 V	TSOT-23	3,000 / Tape & Reel
CAT6221-JPTD-GT3	2.5 V / 3.0 V	TSOT-23	3,000 / Tape & Reel
CAT6221-MFTD-GT3	2.8 V / 1.5 V	TSOT-23	3,000 / Tape & Reel
CAT6221-MGTD-GT3	2.8 V / 1.8 V	TSOT-23	3,000 / Tape & Reel
CAT6221-MLTD-GT3	2.8 V / 2.7 V	TSOT-23	3,000 / Tape & Reel
CAT6221-MPTD-GT3	2.8 V / 3.0 V	TSOT-23	3,000 / Tape & Reel
CAT6221-PFTD-GT3	3.0 V / 1.5 V	TSOT-23	3,000 / Tape & Reel
CAT6221-PGTD-GT3	3.0 V / 1.8 V	TSOT-23	3,000 / Tape & Reel
CAT6221-PLTD-GT3	3.0 V / 2.7 V	TSOT-23	3,000 / Tape & Reel
CAT6221-PPTD-GT3	3.0 V / 3.0 V	TSOT-23	3,000 / Tape & Reel
CAT6221-SFTD-GT3	3.3 V / 1.5 V	TSOT-23	3,000 / Tape & Reel
CAT6221-SGTD-GT3	3.3 V / 1.8 V	TSOT-23	3,000 / Tape & Reel
CAT6221-SLTD-GT3	3.3 V / 2.7 V	TSOT-23	3,000 / Tape & Reel
CAT6221-SPTD-GT3	3.3 V / 3.0 V	TSOT-23	3,000 / Tape & Reel

- All packages are RoHS-compliant (Lead-free, Halogen-free).
- The standard finish is NiPdAu pre-plated (PPF) lead frames.
- The device used in the above example is a CAT6221-MGTD-GT3 (V_{OUT1} = 2.8 V, V_{OUT2} = 1.8 V, in a TSOT-23 package, NiPdAu, Tape & Reel).
- For other voltage options, please contact your nearest ON Semiconductor Sales office.
- For information on tape and reel specifications, including part orientation and tape sizes, please refer to our Tape and Reel Packaging Specifications Brochure, BRD8011/D.

ON Semiconductor and  are registered trademarks of Semiconductor Components Industries, LLC (SCILLC). SCILLC reserves the right to make changes without further notice to any products herein. SCILLC makes no warranty, representation or guarantee regarding the suitability of its products for any particular purpose, nor does SCILLC assume any liability arising out of the application or use of any product or circuit, and specifically disclaims any and all liability, including without limitation special, consequential or incidental damages. "Typical" parameters which may be provided in SCILLC data sheets and/or specifications can and do vary in different applications and actual performance may vary over time. All operating parameters, including "Typicals" must be validated for each customer application by customer's technical experts. SCILLC does not convey any license under its patent rights nor the rights of others. SCILLC products are not designed, intended, or authorized for use as components in systems intended for surgical implant into the body, or other applications intended to support or sustain life, or for any other application in which the failure of the SCILLC product could create a situation where personal injury or death may occur. Should Buyer purchase or use SCILLC products for any such unintended or unauthorized application, Buyer shall indemnify and hold SCILLC and its officers, employees, subsidiaries, affiliates, and distributors harmless against all claims, costs, damages, and expenses, and reasonable attorney fees arising out of, directly or indirectly, any claim of personal injury or death associated with such unintended or unauthorized use, even if such claim alleges that SCILLC was negligent regarding the design or manufacture of the part. SCILLC is an Equal Opportunity/Affirmative Action Employer. This literature is subject to all applicable copyright laws and is not for resale in any manner.

PUBLICATION ORDERING INFORMATION

LITERATURE FULFILLMENT:
Literature Distribution Center for ON Semiconductor
P.O. Box 5163, Denver, Colorado 80217 USA
Phone: 303-675-2175 or 800-344-3860 Toll Free USA/Canada
Fax: 303-675-2176 or 800-344-3867 Toll Free USA/Canada
Email: orderlit@onsemi.com

N. American Technical Support: 800-282-9855 Toll Free
USA/Canada
Europe, Middle East and Africa Technical Support:
Phone: 421 33 790 2910
Japan Customer Focus Center
Phone: 81-3-5773-3850

ON Semiconductor Website: www.onsemi.com

Order Literature: <http://www.onsemi.com/orderlit>

For additional information, please contact your local Sales Representative