



Features

- Lead free as standard
- RoHS compliant*
- Glass passivated chip
- Low reverse leakage current
- Low forward voltage drop
- High current capability

CD214B-R250~R21000 Glass Passivated Rectifiers

General Information

The markets of portable communications, computing and video equipment are challenging the semiconductor industry to develop increasingly smaller electronic components. Bourns offers Glass Passivated Rectifiers for rectification applications, in compact chip DO-214AA (SMB) size format, which offer PCB real estate savings and are considerably smaller than most competitive parts. The Glass Passivated Rectifier Diodes offer a forward current of 2.0 A with a choice of repetitive peak reverse voltage of 50 V up to 1000 V.

Bourns® Chip Diodes conform to JEDEC standards, are easy to handle on standard pick and place equipment and their flat configuration minimizes roll away.

Electrical Characteristics (@ T_A = 25 °C Unless Otherwise Noted)

Parameter	Symbol	CD214B-							Unit
		R250	R2100	R2200	R2400	R2600	R2800	R21000	
Maximum Repetitive Peak Reverse Voltage	V _{RRM}	50	100	200	400	600	800	1000	V
Maximum RMS Voltage	V _{RMS}	35	70	140	280	420	560	700	V
Maximum DC Blocking Voltage	V _{DC}	50	100	200	400	600	800	1000	V
Max. Average Forward Rectified Current ¹	I _(AV)	2.0							A
DC Reverse Current @ Rated DC Blocking Voltage (@T _J = 25 °C)	I _R	5.0							μA
DC Reverse Current @ Rated DC Blocking Voltage (@T _J = 125 °C)	I _R	30							μA
Typical Junction Capacitance ²	C _J	25							pF
Maximum Instantaneous Forward Voltage @ 1 A	V _F	1.0							V
Typical Thermal Resistance ³	R _{θJL}	16							°C/W
Peak forward surge current 8.3 ms single half sine-wave superimposed on rated load (JEDEC Method)	I _{FSM}	65							A

Notes:

1 See Forward Derating Curve.

2 Measured @ 1.0 MHz and applied reverse voltage of 4.0 VDC.

3 Thermal resistance from junction to ambient and from junction to lead P.C.B. mounted on 0.2" x 0.2" (5.0 mm x 5.0 mm) copper pad areas.

Thermal Characteristics (@ T_A = 25 °C Unless Otherwise Noted)

Parameter	Symbol	CD214B-R250~R21000	Unit
Operating Temperature Range	T _J	-65 to +175	°C
Storage Temperature Range	T _{STG}	-65 to +170	°C

CD214B-R250~R21000 Glass Passivated Rectifiers

BOURNS®

Product Dimensions

This is a lead free product. It is a molded plastic package. A cathode band indicates the polarity. The package weighs approximately 0.064 g. The package and dimensions are shown below.

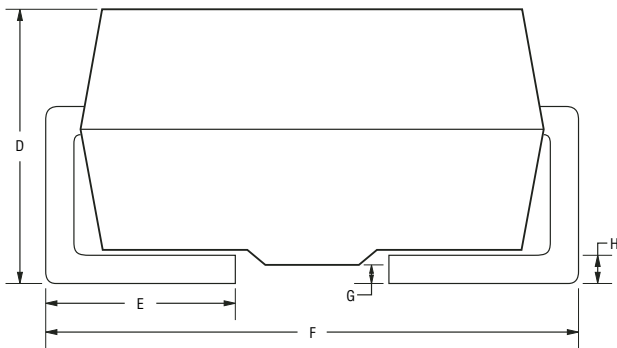
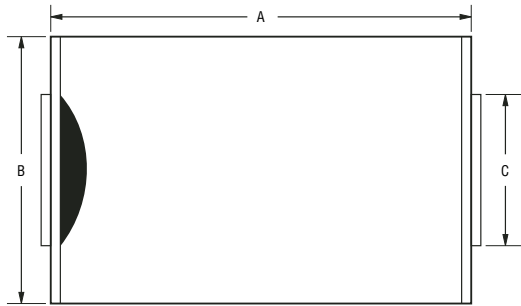

Dimensions	
A	$\frac{4.06 - 4.57}{(0.167 - 0.187)}$
B	$\frac{3.30 - 3.94}{(0.130 - 0.150)}$
C	$\frac{1.96 - 2.21}{(0.075 - 0.087)}$
D	$\frac{2.01 - 2.62}{(0.079 - 0.096)}$
E	$\frac{0.76 - 1.52}{(0.039 - 0.055)}$
F	$\frac{5.21 - 5.59}{(0.197 - 0.236)}$
G	$\frac{0.05 - 0.20}{(0.00196 - 0.00787)}$
H	$\frac{0.15 - 0.31}{(0.006 - 0.016)}$

DIMENSIONS: $\frac{\text{MM}}{\text{(INCHES)}}$

Recommended Pad Layout

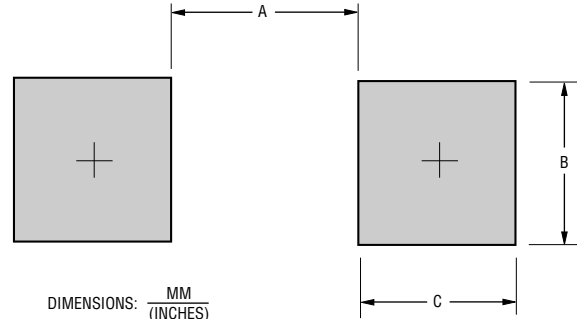

DIMENSIONS: $\frac{\text{MM}}{\text{(INCHES)}}$

Dimension	SMB (DO-214AA)
A (Max.)	$\frac{2.69}{(0.106)}$
B (Min.)	$\frac{2.10}{(0.083)}$
C (Min.)	$\frac{1.27}{(0.050)}$

How To Order

CD 214B - R 2 50

Common Code _____
 Chip Diode _____
 Package _____
 • 214B = SMB/DO-214AA
 Model _____
 R = Glass Pasivated Rectifiers
 Forward Current I_{AV} _____
 2 = 2 A
 Reverse Voltage _____
 50 = 50 V
 100 = 100 V
 200 = 200 V
 400 = 400 V
 600 = 600 V
 800 = 800 V
 1000 = 1000 V

*RoHS Directive 2002/95/EC Jan 27 2003 including Annex
 Specifications are subject to change without notice.
 Customers should verify actual device performance in their specific applications.

CD214B-R250~R21000 Glass Passivated Rectifiers



Rating and Characteristic Curves

Forward Current Derating Curve

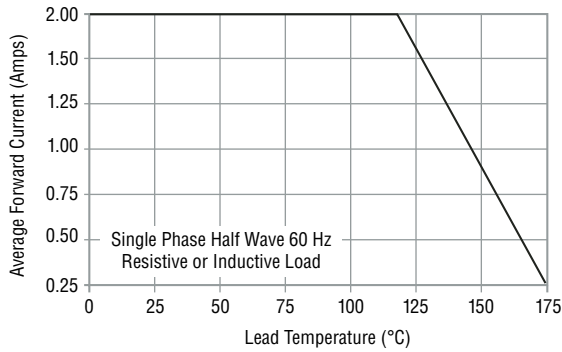

Non-Repetitive Surge Current

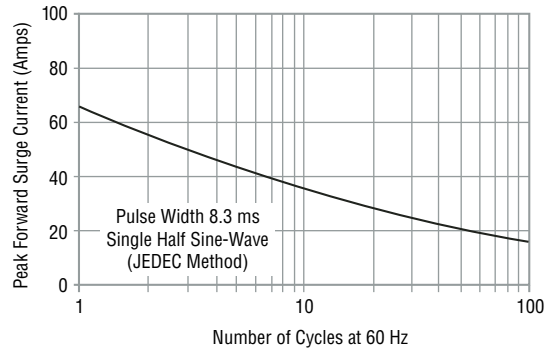

Forward Characteristics

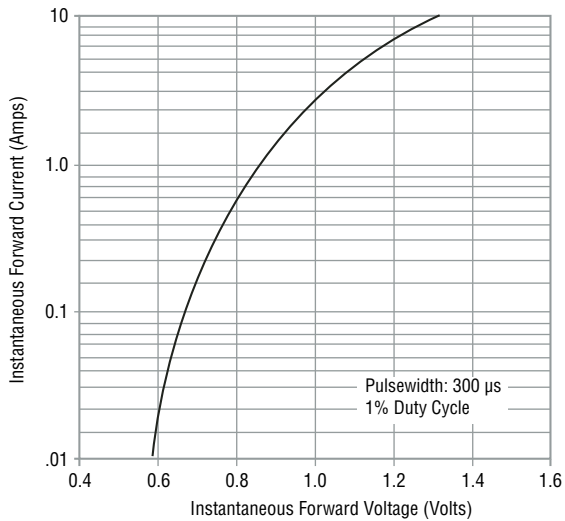

Reverse Characteristics

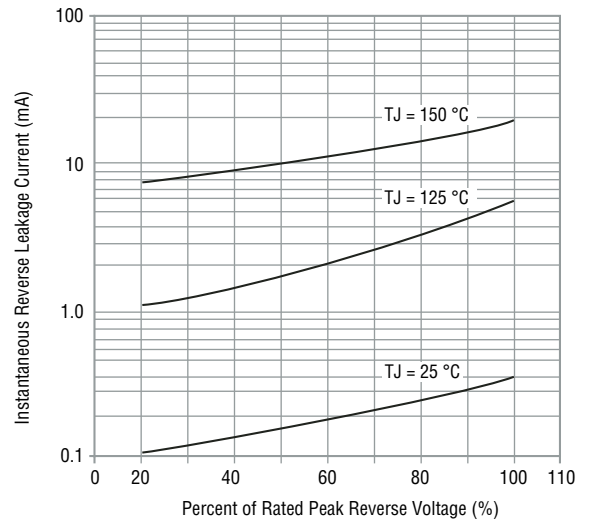

*RoHS Directive 2002/95/EC Jan 27 2003 including Annex
Specifications are subject to change without notice.
Customers should verify actual device performance in their specific applications.

CD214B-R250~R21000 Glass Passivated Rectifiers

BOURNS®

Packaging Information

The surface mount product is packaged in an 8 mm x 4 mm tape and reel format per EIA-481 standard.

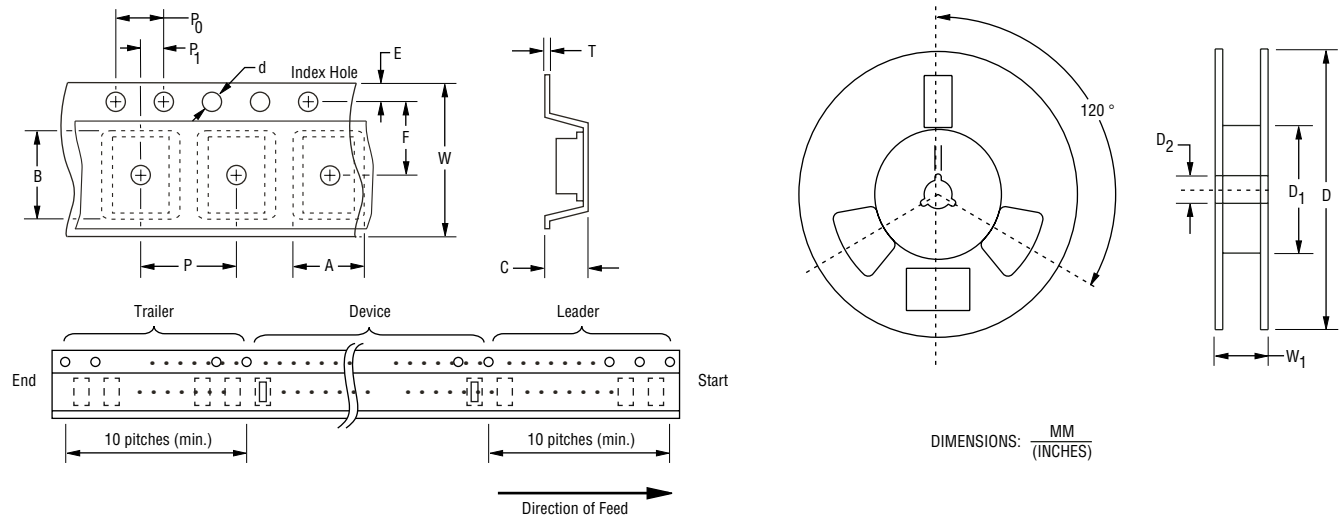

Item	Symbol	DO-214AA (SMB)
Carrier Width	A	$\frac{1.90 \pm 0.10}{(0.075 - 0.004)}$
Carrier Length	B	$\frac{4.30 \pm 0.10}{(0.169 - 0.004)}$
Carrier Depth	C	$\frac{1.80 \pm 0.10}{(0.071 - 0.004)}$
Sprocket Hole	d	$\frac{1.55 \pm 0.05}{(0.061 - 0.002)}$
Reel Outside Diameter	D	$\frac{178}{(7.008)}$
Reel Inner Diameter	D ₁	$\frac{80.0}{(3.150)}$ Min.
Feed Hole Diameter	D ₂	$\frac{13.0 \pm 0.20}{(0.512 - 0.008)}$
Sprocket Hole Position	E	$\frac{1.75 \pm 0.10}{(0.069 - 0.004)}$
Punch Hole Position	F	$\frac{3.50 \pm 0.05}{(0.138 - 0.002)}$
Punch Hole Pitch	P	$\frac{4.00 \pm 0.10}{(0.157 - 0.004)}$
Sprocket Hole Pitch	P ₀	$\frac{4.00 \pm 0.10}{(0.157 - 0.004)}$
Embossment Center	P ₁	$\frac{2.00 \pm 0.05}{(0.079 - 0.002)}$
Overall Tape Thickness	T	$\frac{0.20 \pm 0.10}{(0.008 - 0.004)}$
Tape Width	W	$\frac{8.00 \pm 0.20}{(0.315 - 0.008)}$
Reel Width	W ₁	$\frac{13.5}{(0.531)}$ Max.
Quantity per Reel	—	2,500



Reliable Electronic Solutions

Asia-Pacific:

Tel: +886-2 2562-4117 • Fax: +886-2 2562-4116

Europe:

Tel: +41-41 768 5555 • Fax: +41-41 768 5510

The Americas:

Tel: +1-951 781-5500 • Fax: +1-951 781-5700

www.bourns.com

*RoHS Directive 2002/95/EC Jan 27 2003 including Annex
Specifications are subject to change without notice.
Customers should verify actual device performance in their specific applications.

COPYRIGHT© 2005, BOURNS, INC. LITHO IN U.S.A. IPA0501 10/05