

\*RoHS COMPLIANT

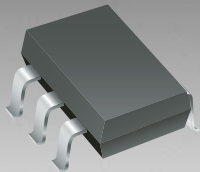

**BOURNS®**

## Features

- Lead free device (RoHS compliant\*)
- Unidirectional & bidirectional configurations
- Protects 4 or 5 lines
- ESD, EFT & surge protection

## Applications

- Cell phones
- PDAs and notebooks
- Digital cameras
- MP3 Players and GPS

# CDSOT236-T05~T24C Series – TVS Diode Arrays

### General Information

The markets of portable communications, computing and video equipment are challenging the semiconductor industry to develop increasingly smaller electronic components.

Bourns offers Transient Voltage Suppressor Array diodes for ESD, EFT and surge protection applications, in SOT23-6 package size format. The Transient Voltage Suppressor Array series offers a choice of voltage types ranging from 5 V to 24 V in a bidirectional configuration. Bourns® Chip Diodes conform to JEDEC standards, are easy to handle on standard pick and place equipment and their flat configuration minimizes roll away.

The Bourns® device will meet IEC 61000-4-2 (ESD), IEC 61000-4-4 (EFT) and IEC 61000-4-5 (Surge) requirements.

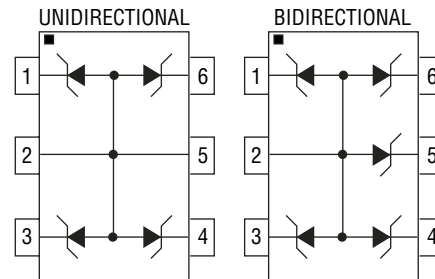

### Electrical & Thermal Characteristics (@ T<sub>A</sub> = 25 °C Unless Otherwise Noted)

Parameter	Symbol	Value	Unit
Peak Pulse Power (t <sub>p</sub> = 8/20 μs) <sup>1</sup>	P <sub>PP</sub>	200	W
Operating Temperature	T <sub>J</sub>	-55 °C to 150 °C	°C
Storage Temperature	T <sub>STG</sub>	-55 °C to 150 °C	°C

Parameter	Symbol	CDSOT236-								Unit
		Uni-T05	Bi-T05C	Uni-T08C	Bi-T12C	Uni-T15C	Bi-T24C	Uni-T36C	Bi-T24C	
Min. Breakdown Voltage @ 1 mA	V <sub>BR</sub>	6.0	6.0	13.3	13.3	16.7	16.7	26.7	26.7	V
Working Peak Voltage	V <sub>WM</sub>	5.0	5.0	12.0	12.0	15.0	15.0	24.0	24.0	V
Maximum Clamping Voltage @ I <sub>p</sub> = 1A	V <sub>C</sub>	9.8	9.8	19.0	19.0	24.0	24.0	43.0	43.0	V
Maximum Clamping Voltage @ 8/20 μs @ I <sub>pp</sub>	V <sub>C</sub>	11.8 V @ 17 A	11.8 V @ 17 A	28.3 V @ 7 A	28.3 V @ 7 A	45.0 V @ 5 A	45.0 V @ 5 A	65.0 V @ 3 A	65.0 V @ 3 A	V
Maximum Leakage Current @ V <sub>WM</sub>	I <sub>D</sub>	20	20	1	1	1	1	1	1	μA
Typical Capacitance @ 0 V, 1 MHz	C <sub>J</sub>	70	70	50	50	30	30	25	25	pF



Reliable Electronic Solutions

**Asia-Pacific:**

Tel: +886-2 2562-4117 • Fax: +886-2 2562-4116

**Europe:**

Tel: +41-41 768 5555 • Fax: +41-41 768 5510

**The Americas:**

Tel: +1-951 781-5500 • Fax: +1-951 781-5700

[www.bourns.com](http://www.bourns.com)

\*RoHS Directive 2002/95/EC Jan 27 2003 including Annex.

Specifications are subject to change without notice.

Customers should verify actual device performance in their specific applications.

# CDSOT236-T05~T24C Series – TVS Diode Arrays



## Mechanical Characteristics

This is a molded JEDEC SOT23-6 package with lead free 100 % Tin (Sn) on the lead frame. It weighs approximately 15 mg and has a flammability rating of UL 94V-0.

## Product Dimensions

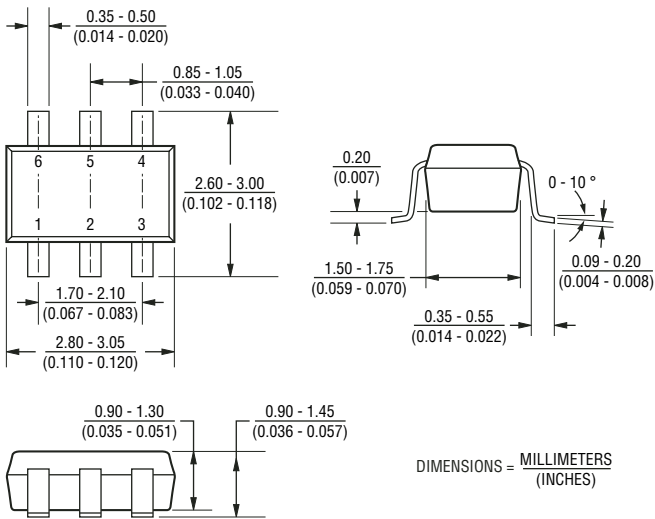

## Recommended Footprint

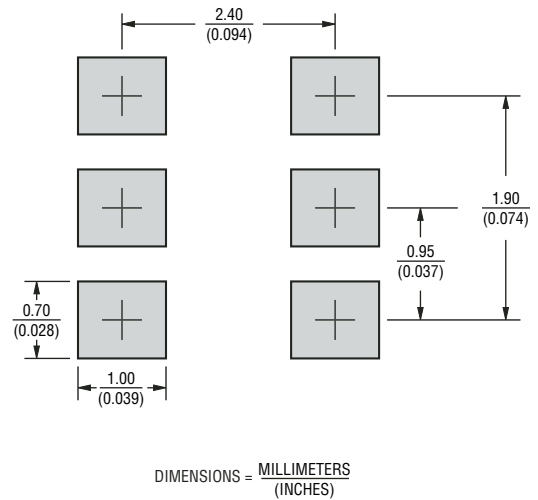

## Packaging Information

The surface mount product will be dispensed in an 8 mm x 4 mm Tape and Reel format per EIA-481 standard.

TOP SIDE VIEW  
(INTO COMPONENT POCKET)

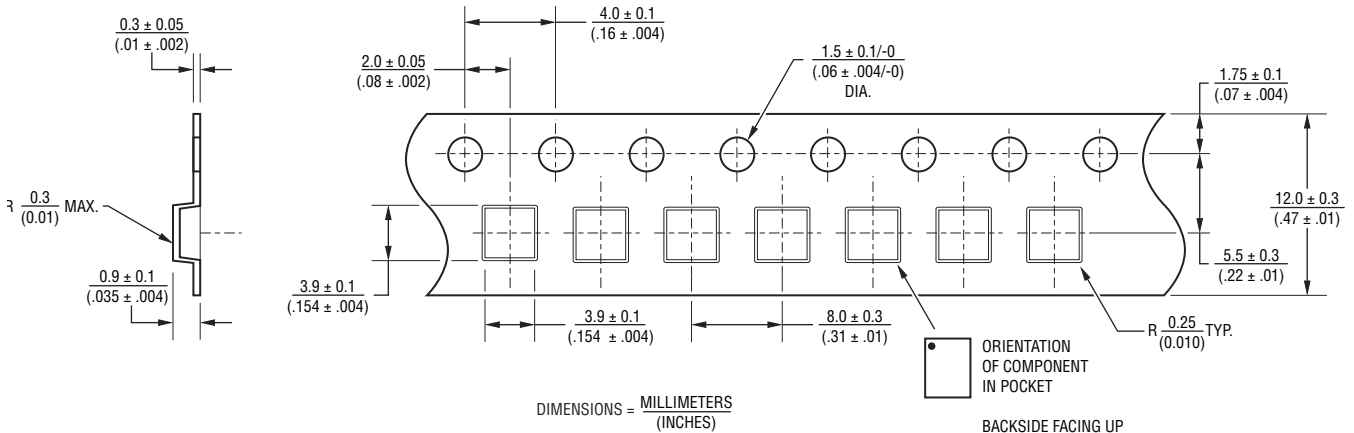

Devices are packed in accordance with EIA standard RS-481-A and specifications shown here.

# CDSOT236-T05~T24C Series – TVS Diode Arrays



## Performance Graphs

### Peak Pulse Power vs Pulse Time

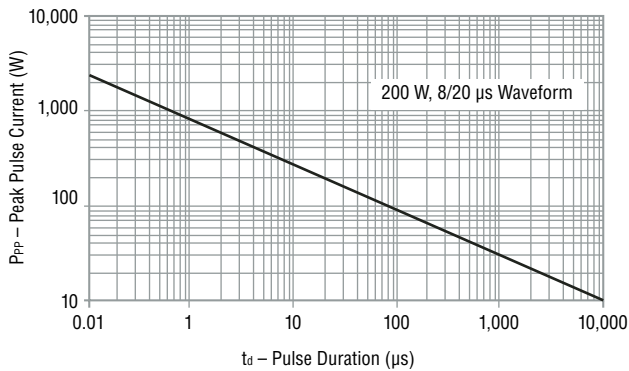

### Pulse Wave Form

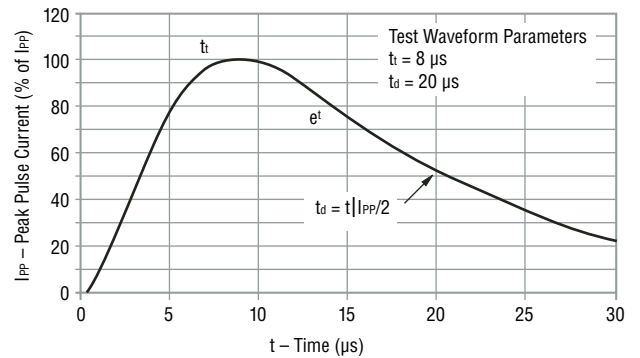

### Power Derating Curve

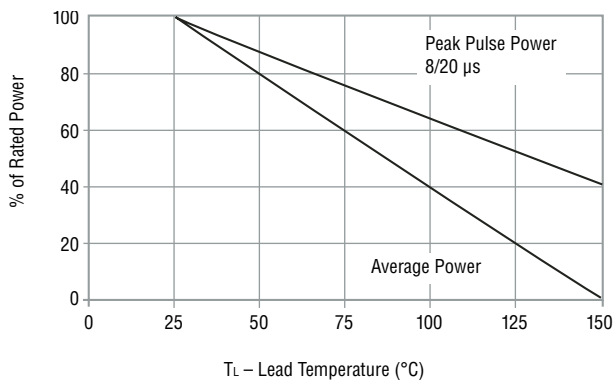

### Overshoot & Clamping Voltage

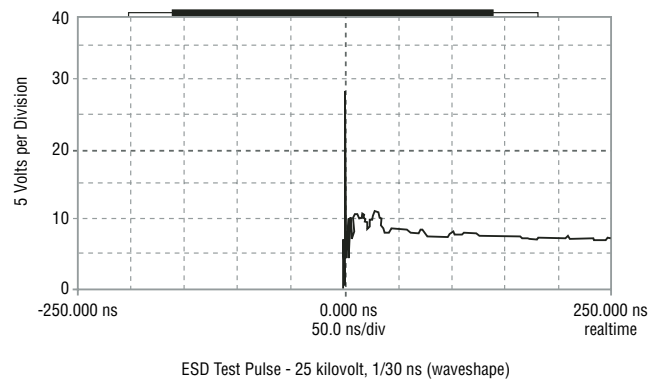

### How To Order

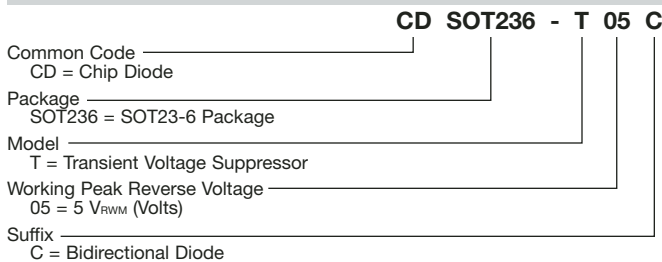

### Typical Part Marking

CDSOT236-T05.....	QRH
CDSOT236-T05C .....	QRL
CDSOT236-T12.....	QRI
CDSOT236-T12C .....	QRM
CDSOT236-T15.....	QRJ
CDSOT236-T15C .....	QRN
CDSOT236-T24.....	QRK
CDSOT236-T24C .....	QRO

### Block Diagram

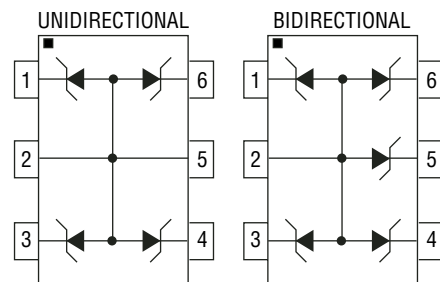

Specifications are subject to change without notice.  
 Customers should verify actual device performance in their specific applications.