

CDSV3-202N-G/202P-G

Reverse Voltage: 80 Volts
Power Dissipation: 200 mW
RoHS Device

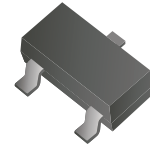

Features

- Design for mounting on small surface.
- High speed switching.
- High mounting capability, strong surge withstand, high reliability.

Mechanical data

- Case: SOT-323, molded plastic.
- Terminals: solderable per MIL-STD-750, method 2026.
- Approx. weight: 0.006 grams

Circuit diagram

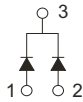

CDSV3-202N-G

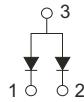

CDSV3-202P-G

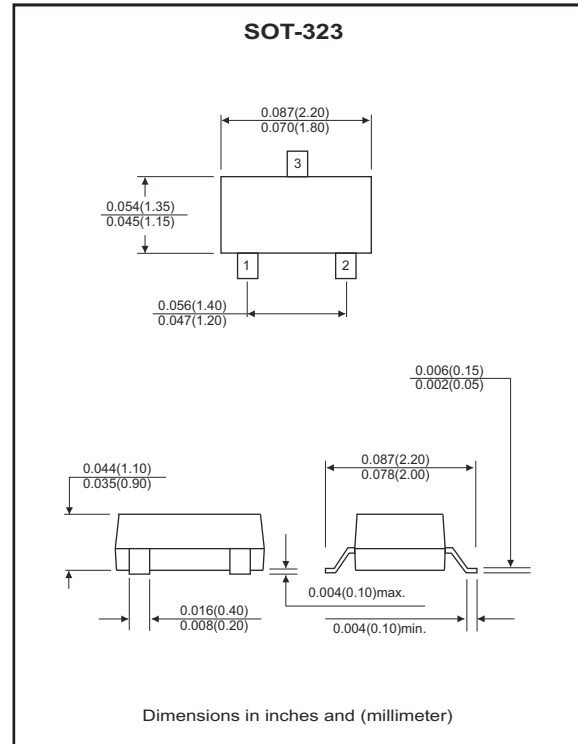

Maximum Ratings and Electrical Characteristics

(at Ta=25 °C unless otherwise noted)

Parameter	Symbol	Conditions	Value	Units
Repetitive peak reverse voltage	V_{RRM}		80	V
Reverse voltage	V_R		80	V
Peak forward current	I_F		300	mA
Peak surge forward current	I_{FSM}	T=1.0 sec	4	A
Power dissipation	P_D		200	mW
Maximum forward voltage	V_F	@ $I_F=100mA$	1.2	V
Maximum reverse current	I_R	@ $V_R=70V$	0.1	μA
Maximum reverse recovery time	T_{rr}	$I_F=I_R=5mA, V_R=6V$	4	nS
Maximum diode capacitance	C_J	$V_R=6V, f=1.0MHz$	3.5	pF
Maximum junction temperature	T_J		150	°C
Storage temperature	T_{STG}		-55 to +150	°C

RATING AND CHARACTERISTIC CURVES (CDSV3-202N-G/202P-G)

Fig.1 - Forward Characteristics (P type)

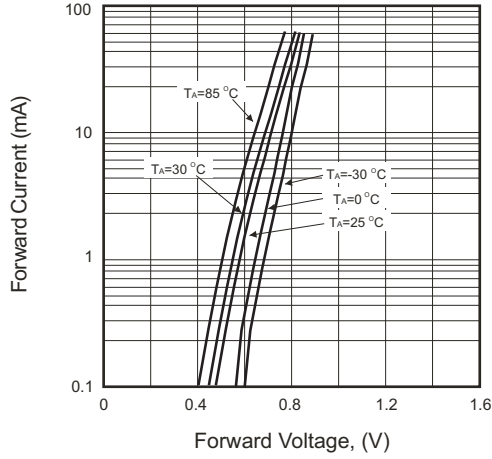

Fig.2 - Reverse Characteristics (P type)

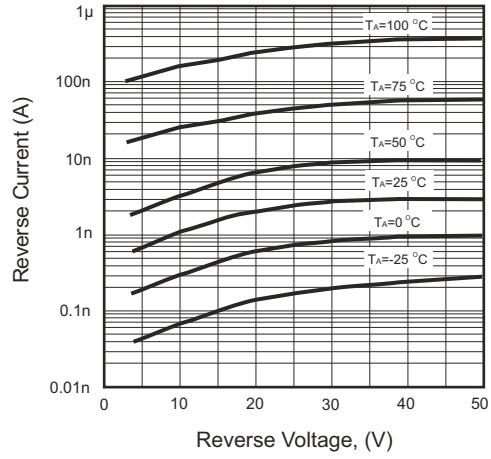

Fig.3 - Forward Characteristics (N type)

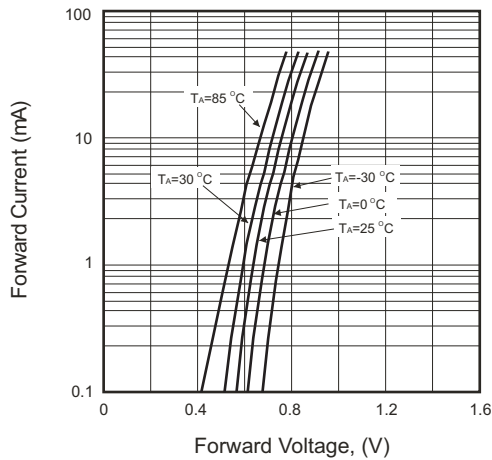

Fig.4 - Reverse Characteristics (N type)

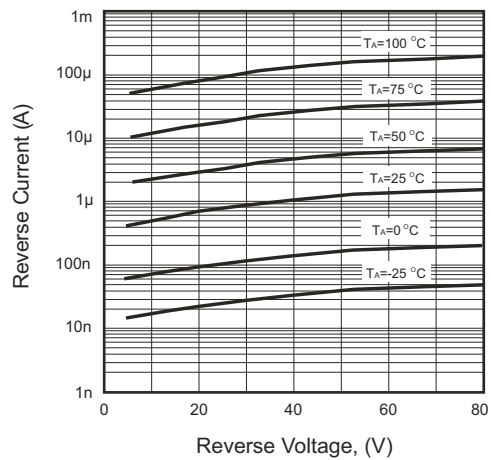

Fig.5 - Capacitance Between Terminals Characteristics

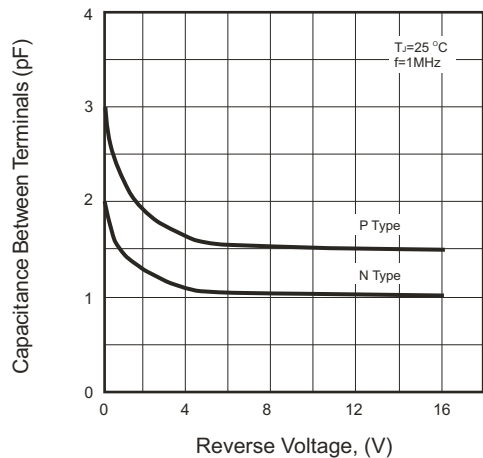

Fig.6 - Power Derating Curve

