

## GaAs MMIC

- Tri mode power amplifier for AMPS/ CDMA /TDMA portable cellular phones
- Dual band operation
- 31.5 dBm saturated output power @ **PAE**=55% typ.  
29 dBm linear output power @ **PAE**=40% typ.
- Two independent amplifier chains
- Power ramp control
- Input matched to 50 ohms, simple output match on PCB

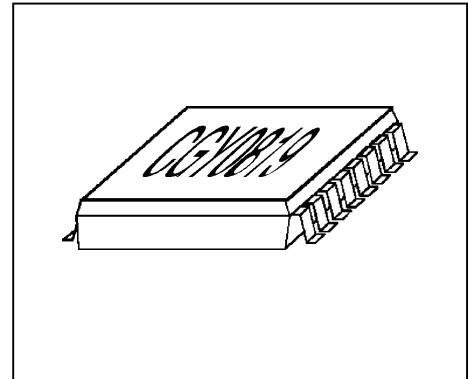

ESD: **E**lectrostatic **d**ischarge sensitive device, observe handling precautions!

Type	Marking	Ordering code (taped)	Package
CGY 0819	CGY 0819	Q62702G0076	MW 16

## Maximum ratings

Characteristics	Symbol	max. Value	Unit
Positive supply voltage	$V_D$	9	V
Supply current	$I_D$	4	A
Channel temperature	$T_{Ch}$	150	°C
Storage temperature	$T_{stg}$	-55...+150	°C
Pulse peak power dissipation <i>duty cycle 12.5%, <math>t_{on}=0.577ms</math></i>	$P_{Pulse}$	tbd	W
Total power dissipation ( $T_s \leq 80\text{ °C}$ ) <i><math>T_s</math>: Temperature at soldering point</i>	$P_{tot}$	tbd	W

## Thermal Resistance

Characteristics	Symbol	max. Value	Unit
Channel-soldering point	$R_{thChS}$	11	K/W

**Functional Block Diagram:**

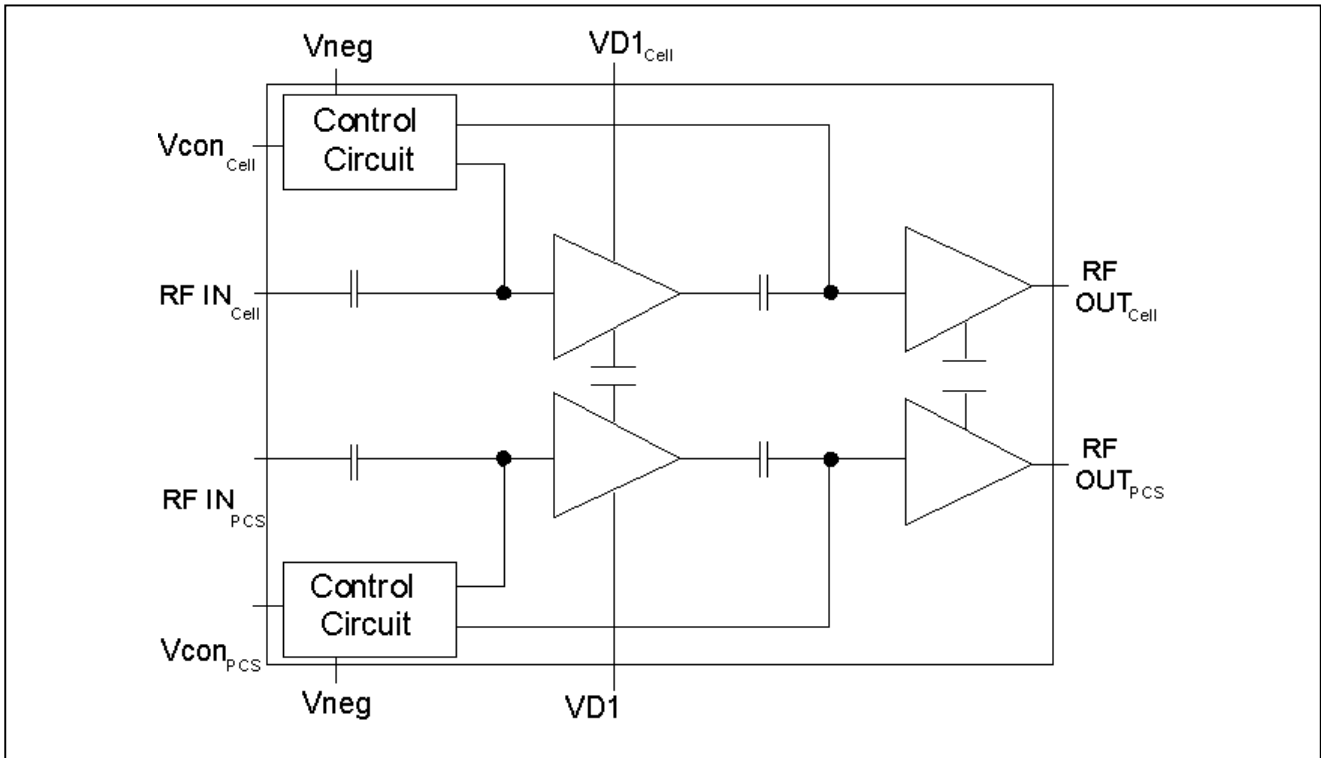

**Pin Configuration:**

Pin #	Name	Configuration
1	VD Cell	Drain voltage cell preamplifier stage
2	RF IN Cell	RF IN Cell Band
3	Vneg	Negative voltage
4	Vcon cell	Control voltage cell. PA
5	Vcon PCS	Control voltage PCS PA
6	Vneg	Negative voltage
7	RF IN PCS	RF IN PCS Band
8	VD PCS	Drain voltage PCS preamplifier stage
9	RF out PCS	RF out PCS
10	RF out PCS	RF out PCS
11	RF out PCS	RF out PCS
12	RF out PCS	RF out PCS
13	GND	RF Ground
14	RF out Cell	RF out Cell
15	RF out Cell	RF out Cell
16	RF out Cell	RF out Cell

## Electrical Characteristics

( $T_A = 25^\circ\text{C}$  ,  $Z_S=Z_L=50\ \Omega$ ,  $V_D=3.5\text{V}$ ,  $I_{DQ}=300\text{mA}$ , unless otherwise specified )

Characteristics	Symbol	min	typ	max	Unit
Frequency range Cellular frequency band PCS frequency band	$f$	824 1850		849 1910	MHz
Duty cycle	$t_{ON}/t_{OFF}$			100	%
AMPS output power	$P$		31,5		dBm
TDMA cellular output power	$P$		30		dBm
AMPS gain at max. output	$G$		24		dB
TDMA cellular gain at max. output	$G$		27		dB
TDMA PCS output power	$P$		29		dBm
TDMA PCS gain at max. output	$G$		24		dB
CDMA cellular output power	$P$		28		dBm
CDMA cellular gain at max. output	$G$		28		dB
CDMA PCS output power	$P$		29		dBm
CDMA PCS gain at max. output	$G$		24		dB
Power ramping characteristic Full output power Pinch off	$V_{contr}$		2.5 0.5		V
Adjacent Channel Power CDMA 900kHz offset (cellular band) 1.25 MHz offset (PCS band) 1.98 MHz offset	$P_{adj}/P_{main}$			-45 -45 -54	dBc @ 30kHz
Adjacent channel power TDMA adjacent alternate 2nd alternate	$P_{adj}/P_{main}$			-28 -45 -45	dBc @ 30kHz
AMPS efficiency	PAE		55		%
TDMA DC to RF efficiency @ $P_{adj}=-26\text{dBc}$ at max. output Cellular Band: PCS Band	PAE		40 40		%
CDMA DC to RF efficiency @ $P_{adj}=-42\text{dBc}$ at max. output Cellular Band PCS Band  at $P_{out}=10\ \text{dBm}$ ( $I_q$ set to 100mA )	PAE		35 40  8		%

Characteristics	Symbol	min	typ	max	Unit
Receive band noise power density Cell band ( 869 to 894 MHz ) PCS band ( 1930 to 1990 MHz )	$P_{RX}$			-137 -145	dBm/Hz
DC supply voltage range	VD	3	3.5	4.0	V
Negative supply voltage range	Vneg	-5.0		-7	V
Standby current @Vcon=0V	$I_{pwr\ dwn}$		500		$\mu$ A
Quiescent current	$I_Q$		300		mA
Current consumption at $V_{Contr}$	$I_{Control}$		2		mA
Current consumption at $V_{NEG}$	$I_{NEG}$		2		mA
Operating temperature range	$\upsilon$	-30		+85	$^{\circ}$ C

**Power on sequence:**

1. connect negative voltage to PA
2. connect control voltage to PA
3. turn on Vd
4. turn on Pin

To switch off the device please use reverse sequence.

## Application Circuit:

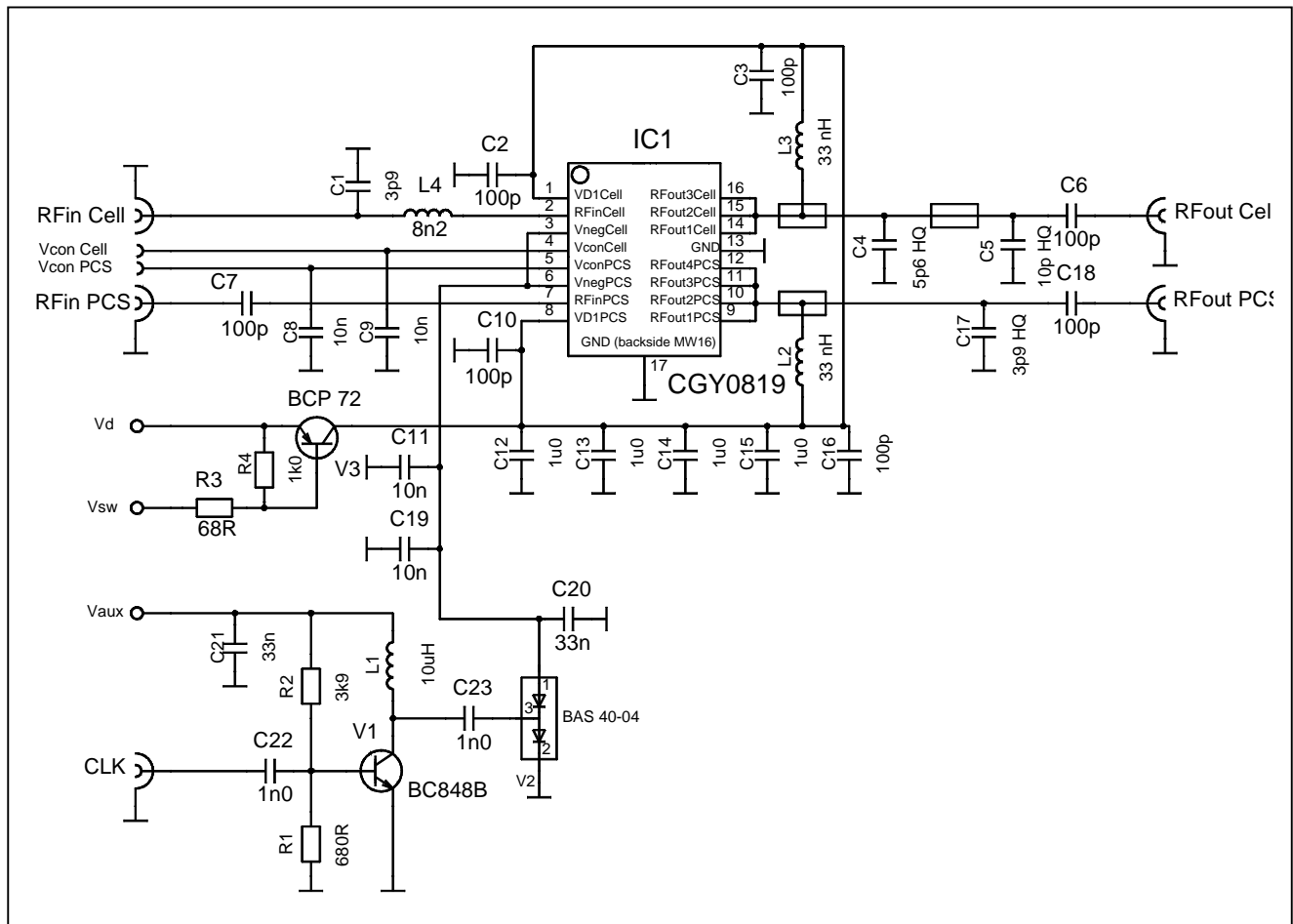

## Evaluation Board Parts List

Part Type	Position	Description	Manufacturer	Part Number
Capacitor	C1	3.9pF 0403	Siemens	
Capacitor	C2, C3, C6, C7, C10, C16, C18	100pF 0402	Siemens	
Capacitor	C4	5.6pF 0603 HQ	AVX	06035J5R6GBT
Capacitor	C5	10pF 0603 HQ	AVX	06035J100GBT
Capacitor	C8, C9, C11, C19	10nF0402	Siemens	
Capacitor	C12, C13, C14, C15	1u0 1206		
Capacitor	C17	3.9pF 0603 HQ	AVX	06035J3R9BBT
Capacitor	C20, C21	33nF 0402	Siemens	
Capacitor	C22, C23	1nF 0402	Siemens	

Part Type	Position	Description	Manufacturer	Part Number
Inductor	L1	10uH	Siemens	
Inductor	L2, L3	Air Coil 33nH	H. David GmbH	PN/BV 1250
Inductor	L4	8.2nH 0603	TOKO	
Resistor	R1	680 Ohm 0402		
Resistor	R2	3.9k 0402		
Resistor	R3	68 Ohm 0805		
Resistor	R4	1.0k 0402		
Transistor	V1	BC848B	Siemens	
Diode	V2	BAS40-04W	Siemens	
Transistor	V3	BCP72	Siemens	
IC	IC1	CGY0819	Siemens	
Substrate		FR4, h=0.2mm, $\epsilon_r=4.5$	Siemens	

### Evaluation Board:

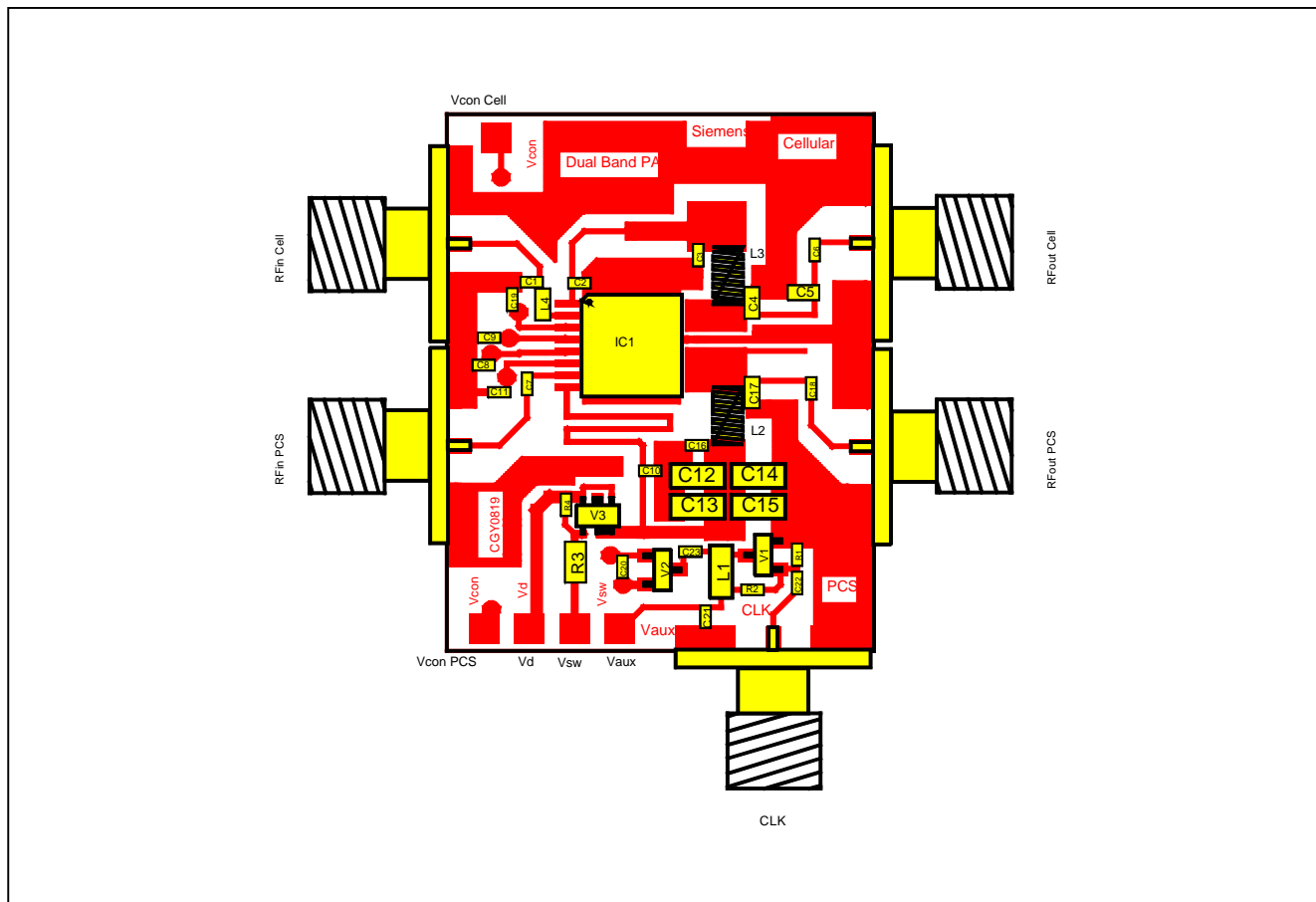

## Typical Performance in Cellular AMPS Operation Mode

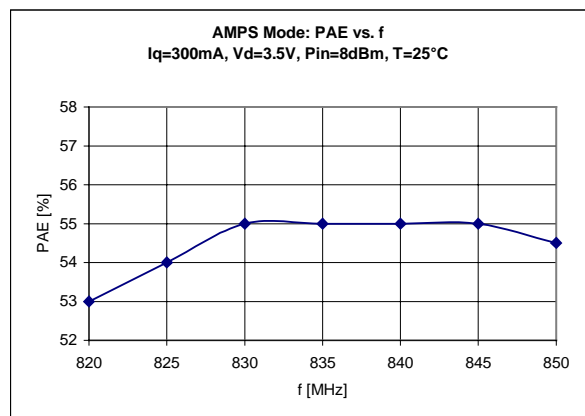
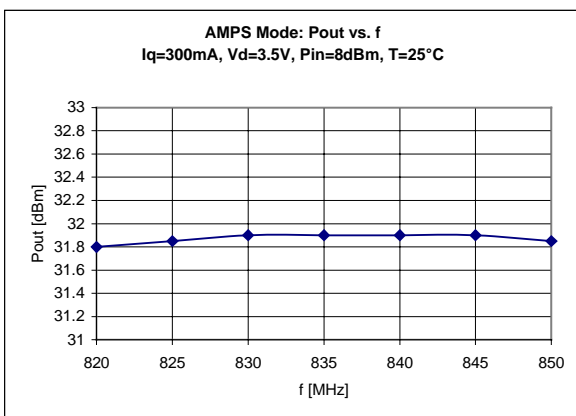
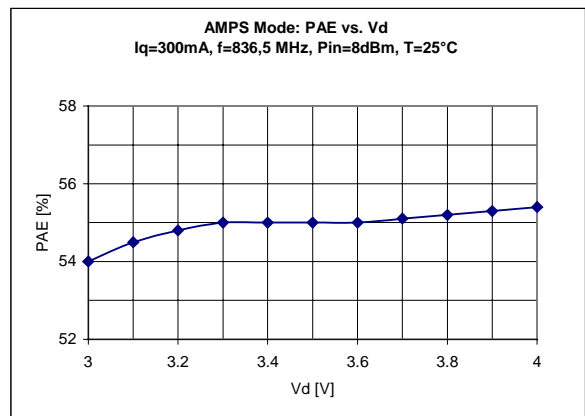
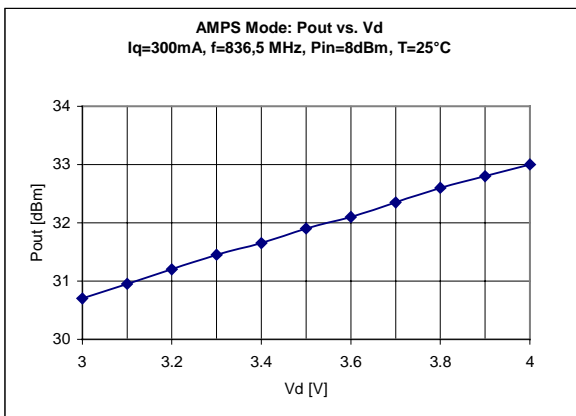
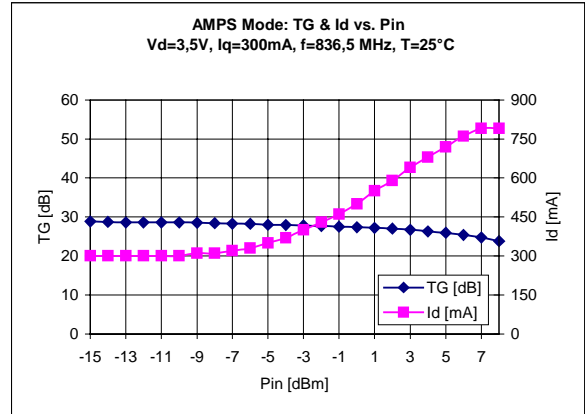
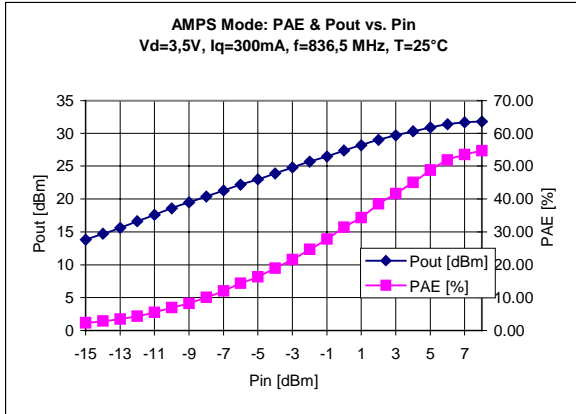

## Typical Performance in Cellular CDMA Operation Mode:

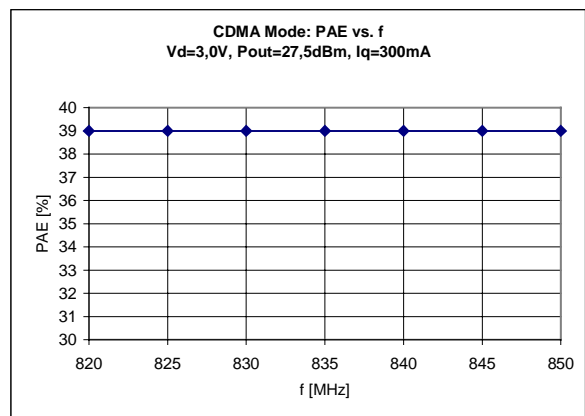
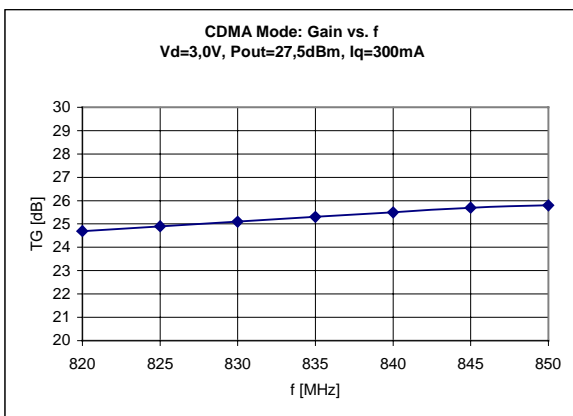
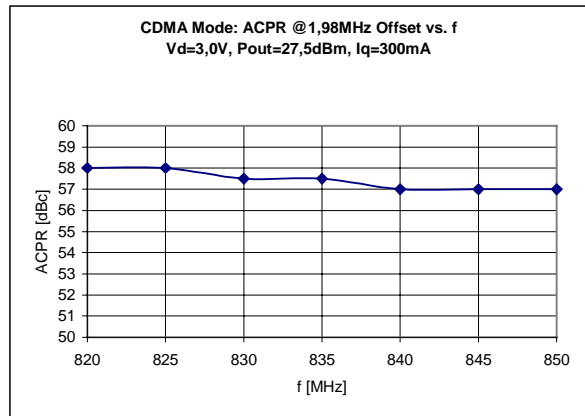
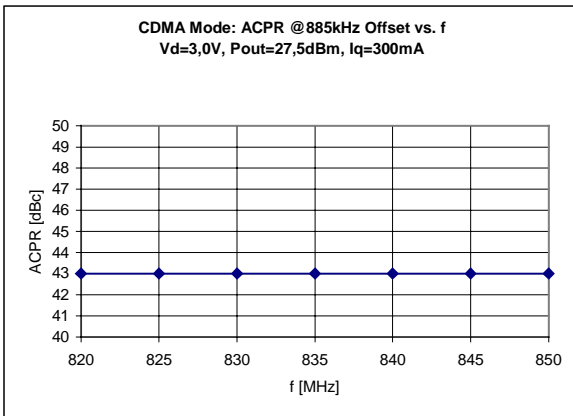
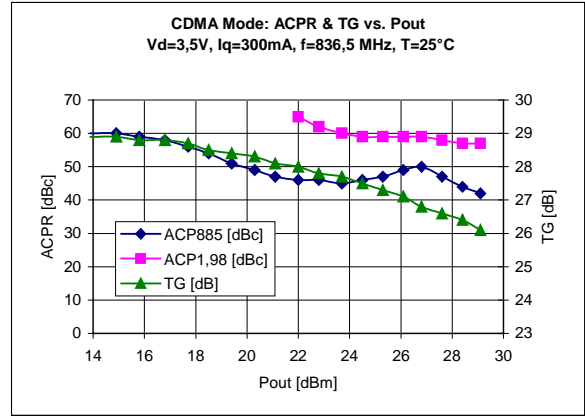
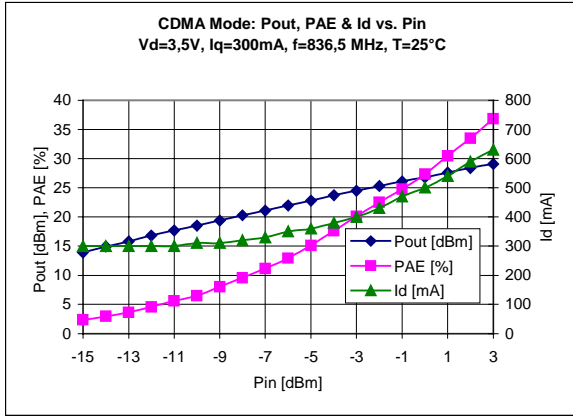



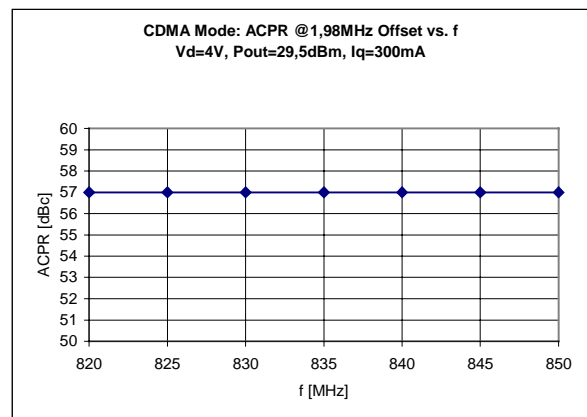
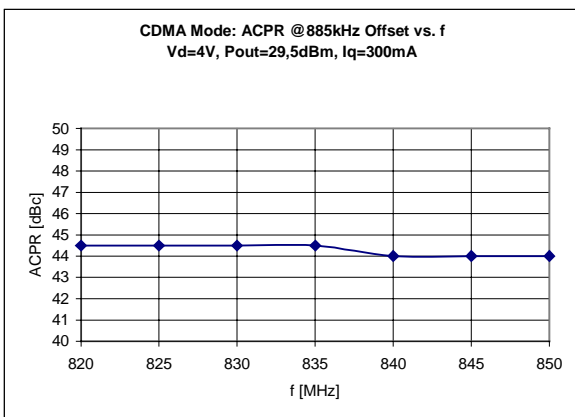
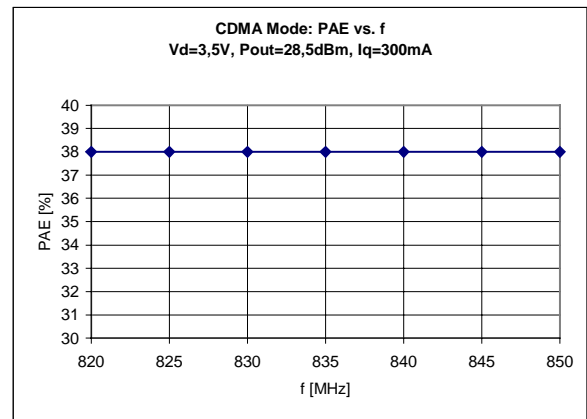
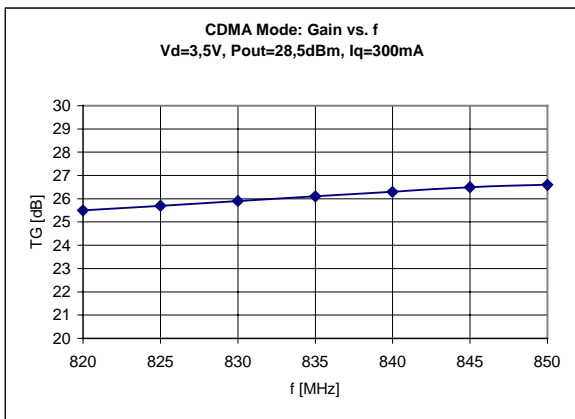
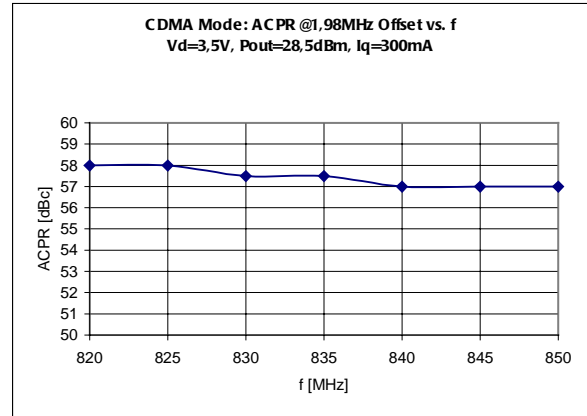
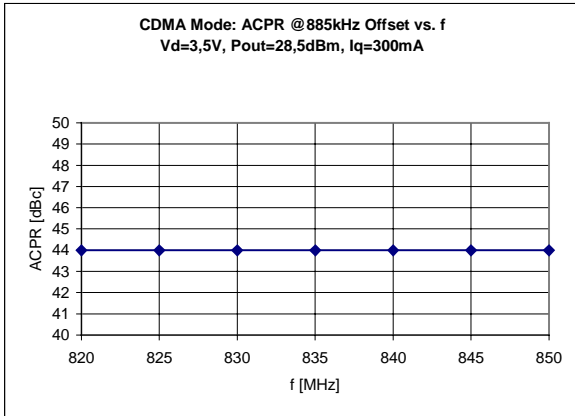

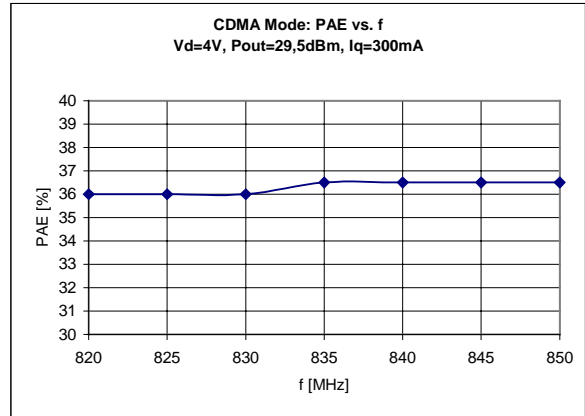
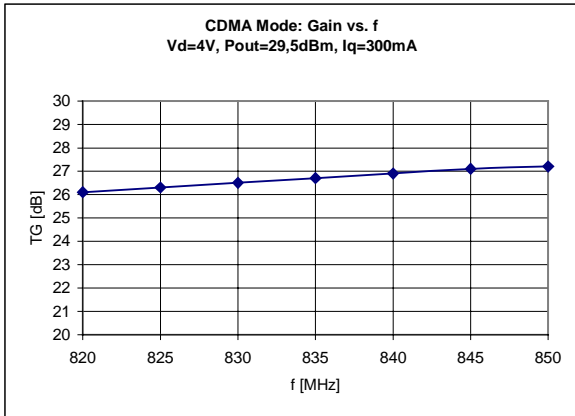

**Typical Performance in Cellular TDMA Operation Mode**

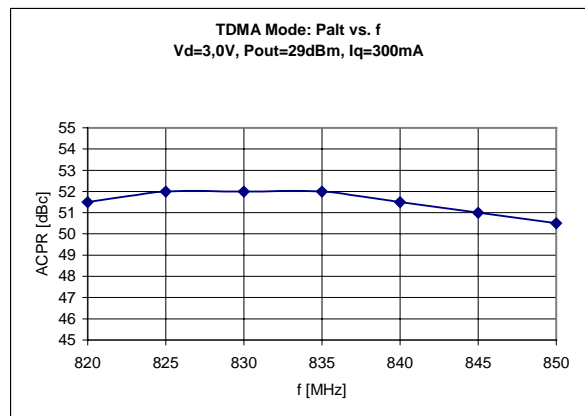
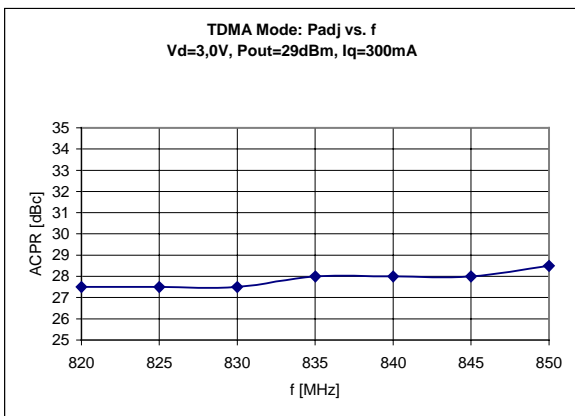
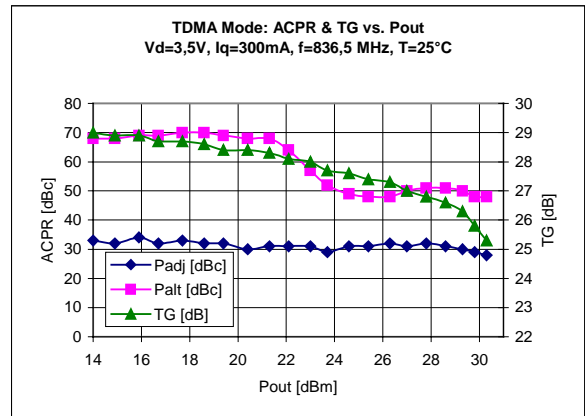
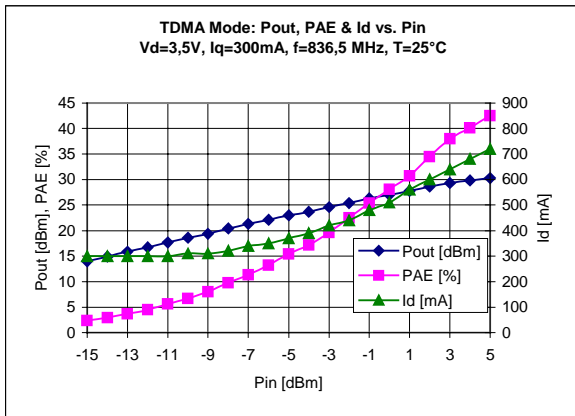

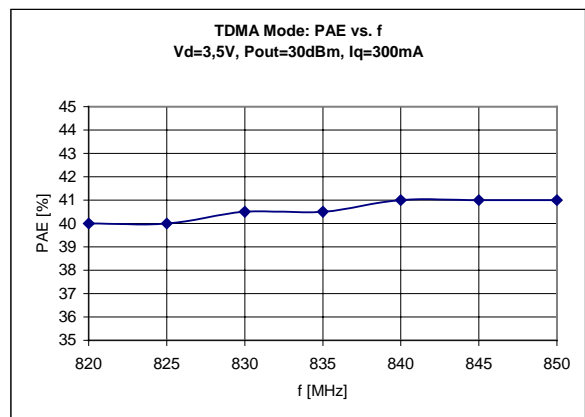
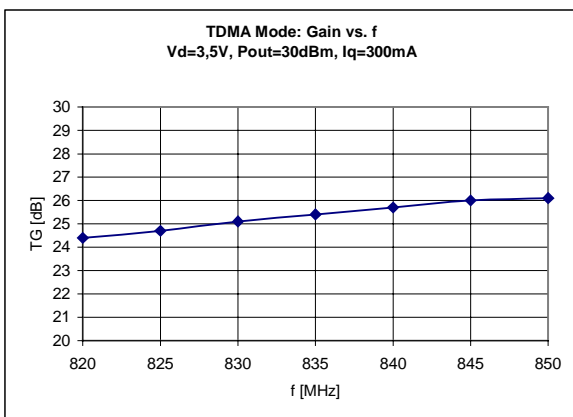
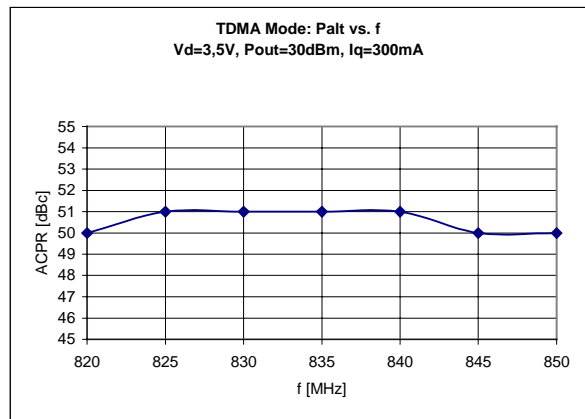
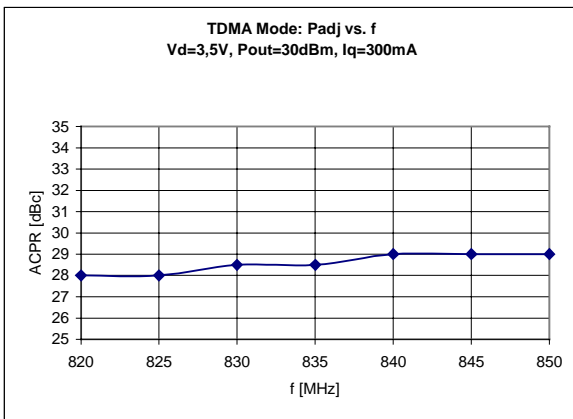
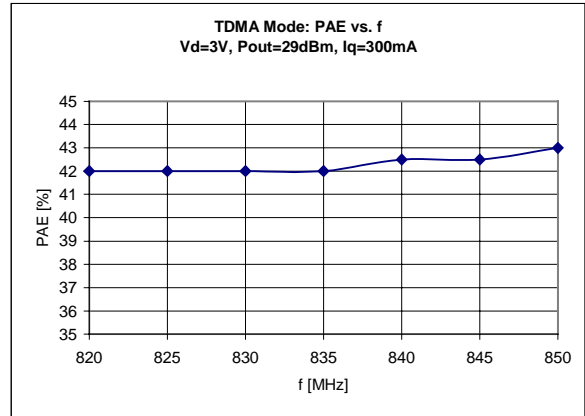
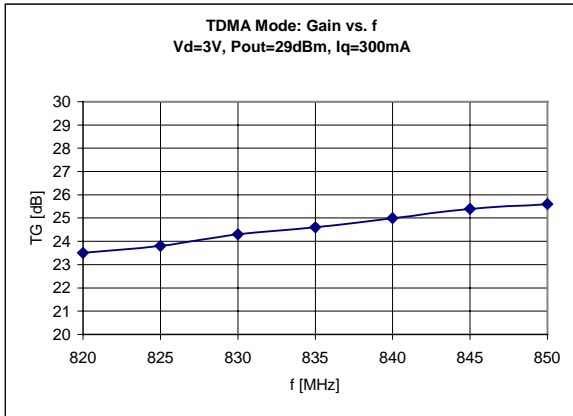

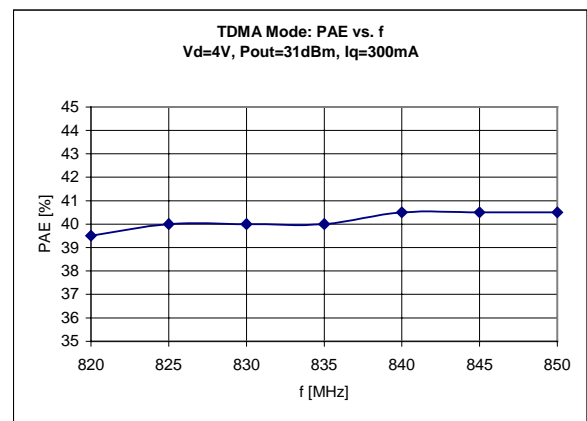
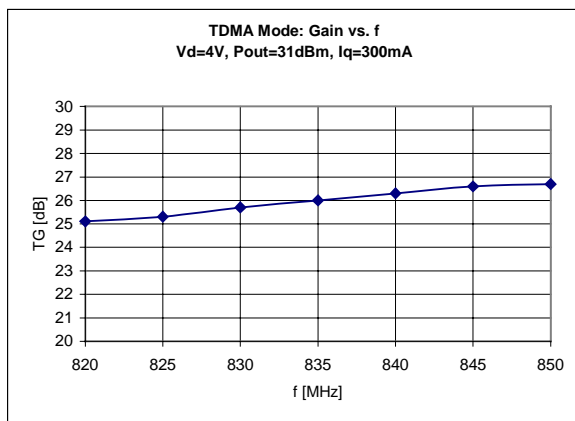
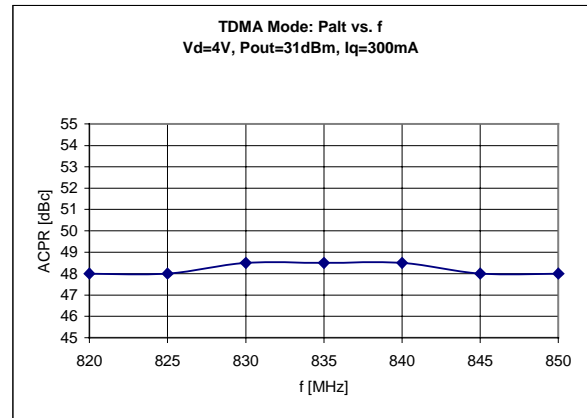
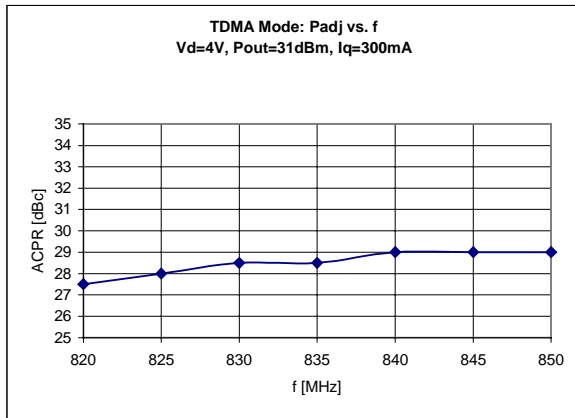

## Typical Performance in PCS CDMA Operation Mode:

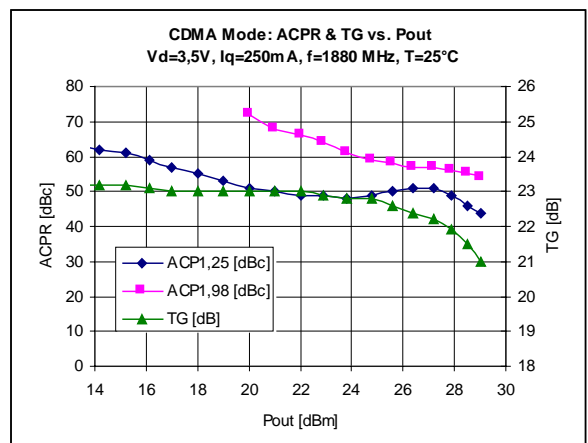
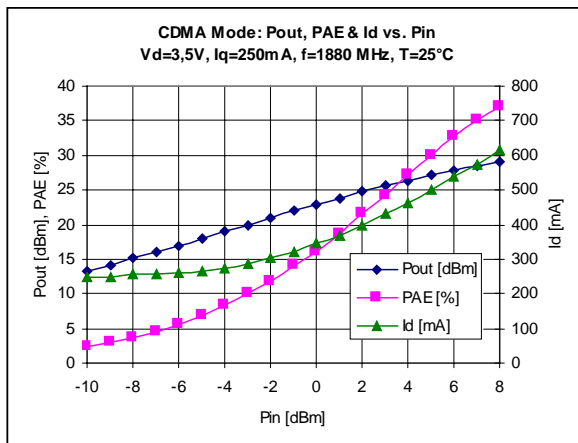

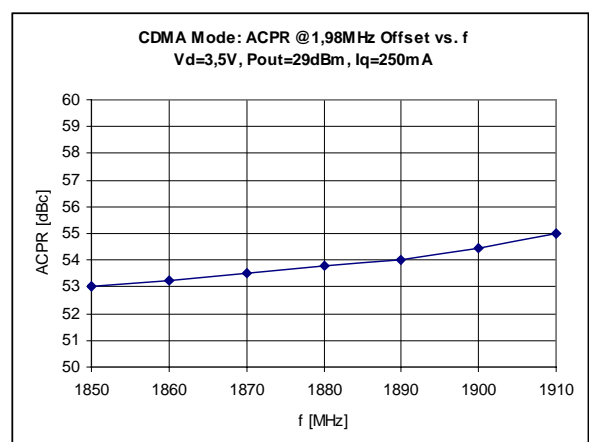
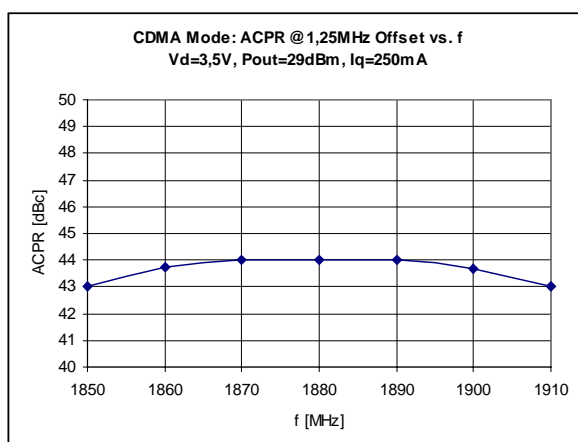
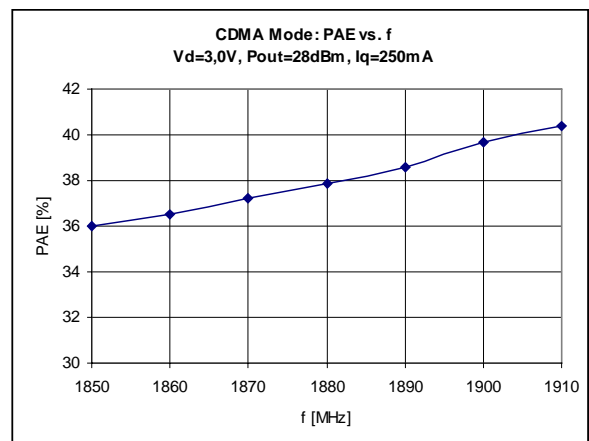
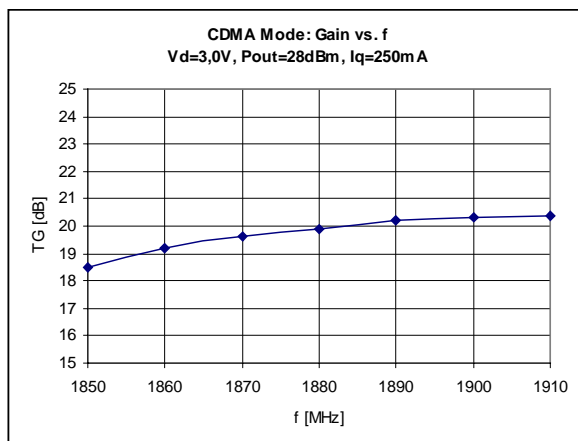
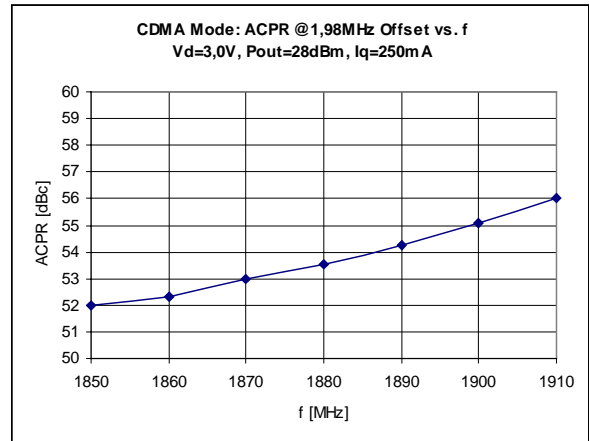
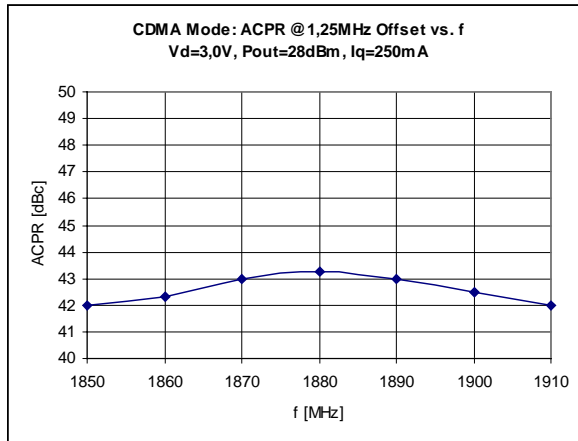

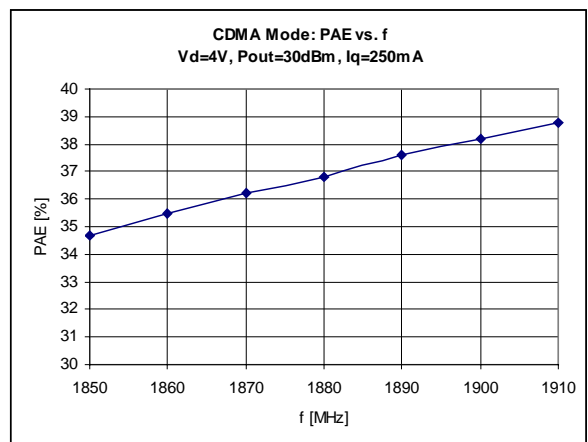
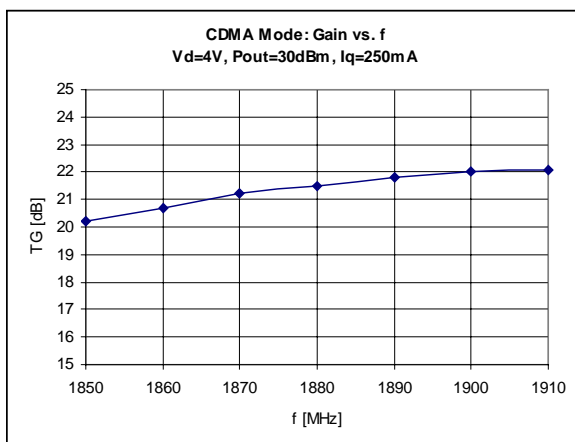
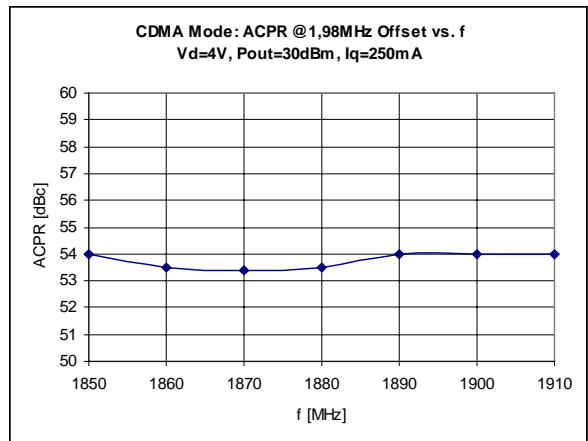
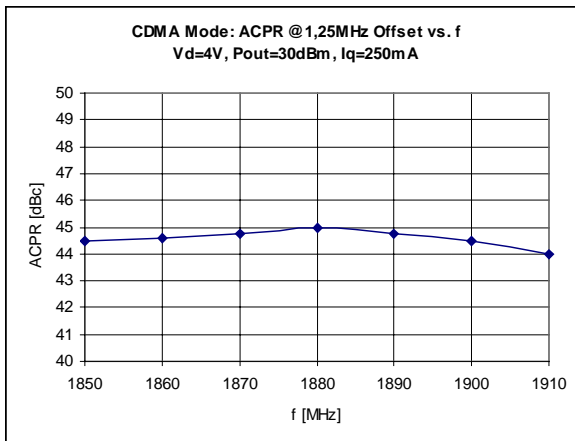
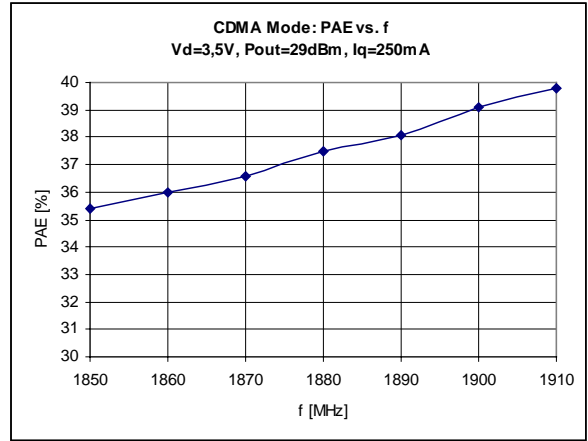
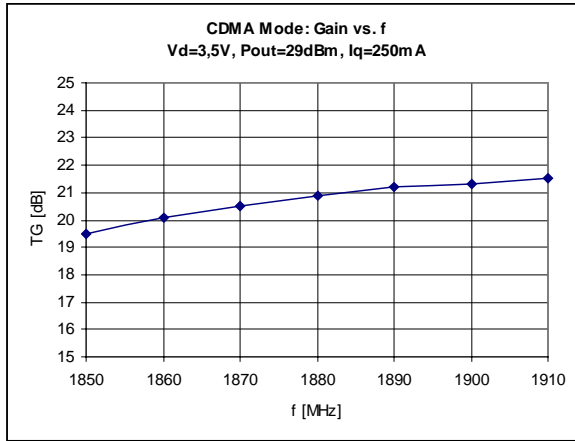

## Typical Performance in PCS TDMA Operation Mode:

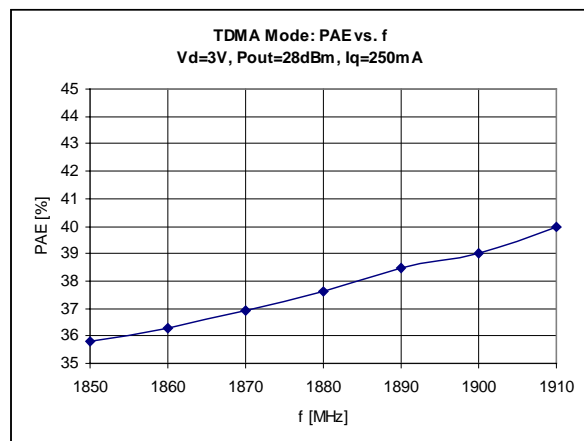
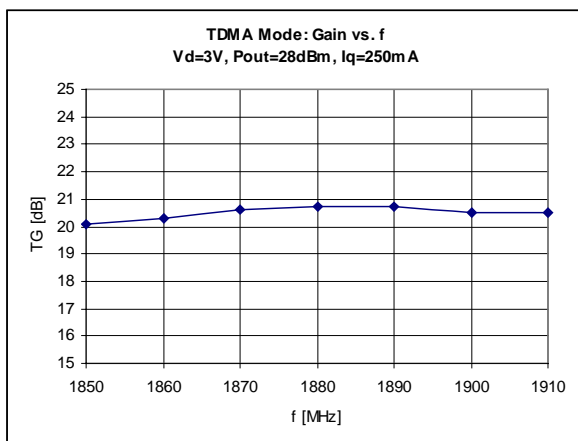
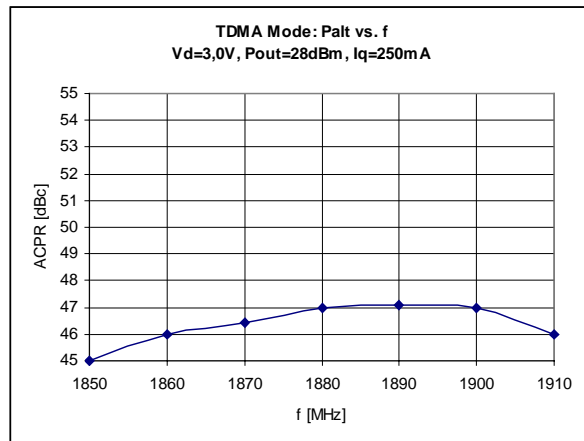
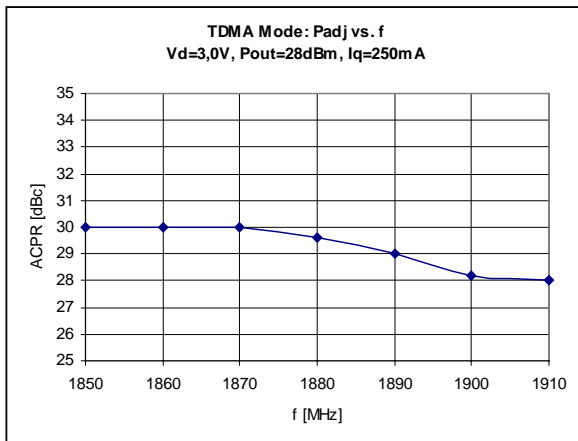
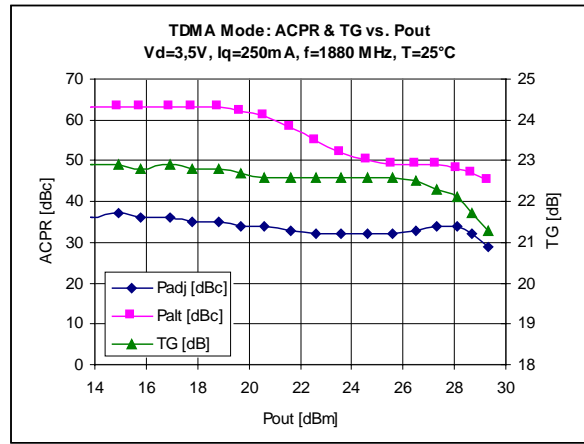
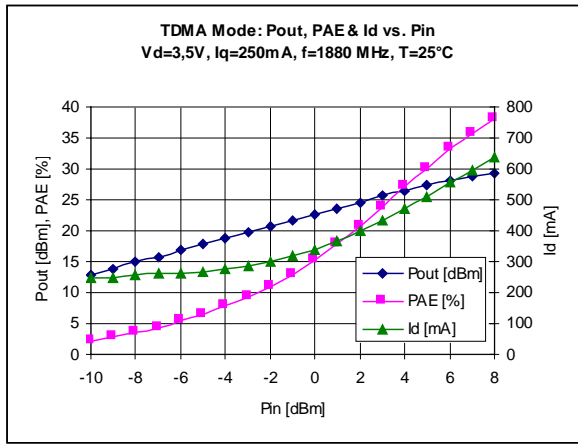

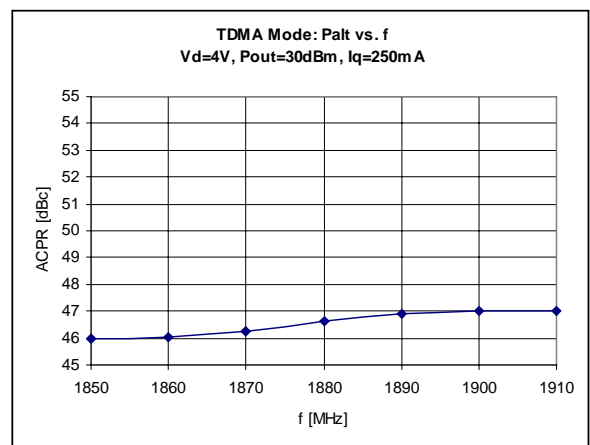
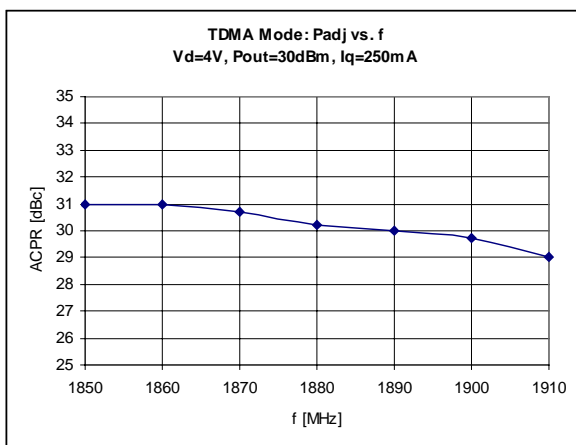
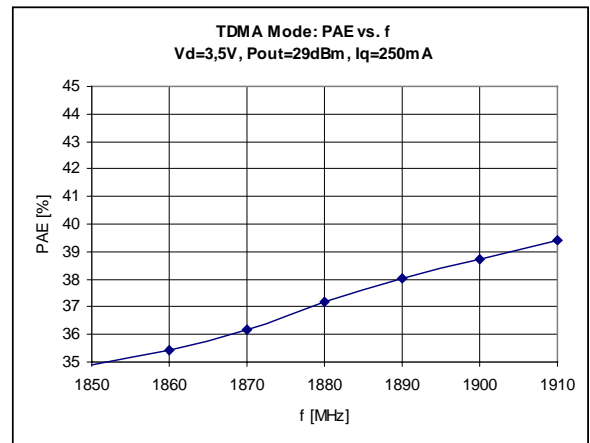
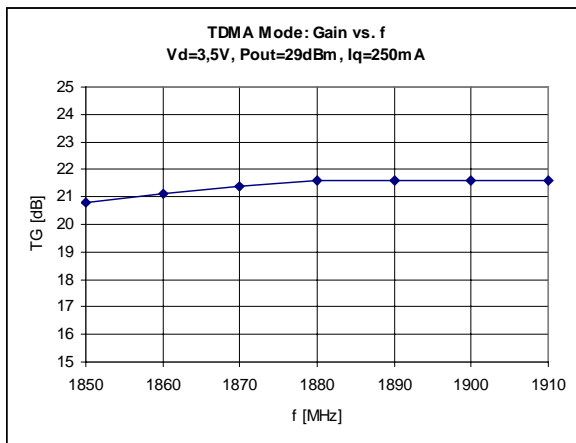
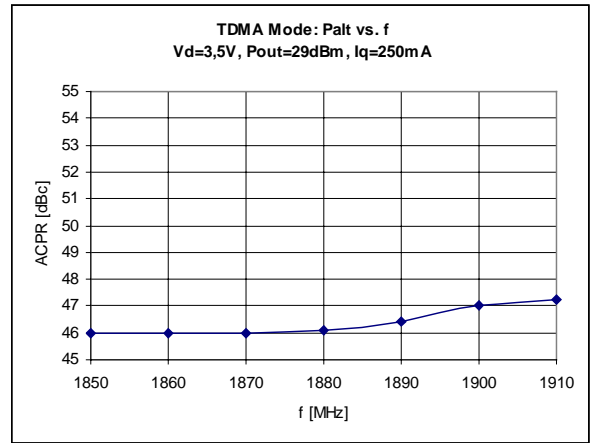
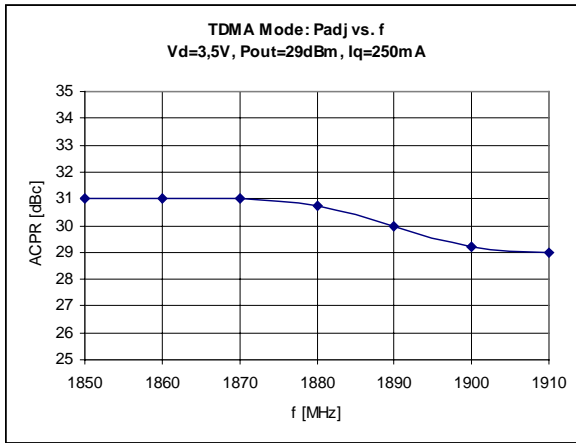



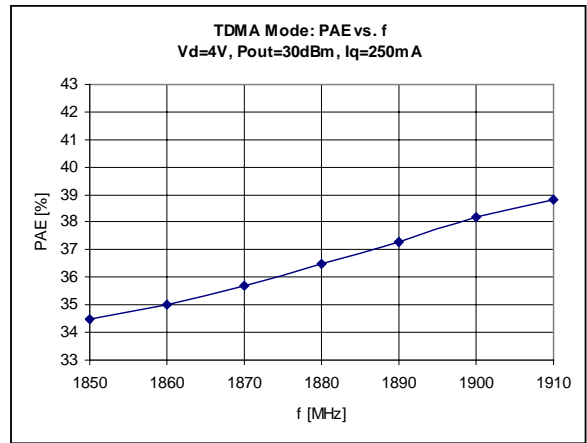
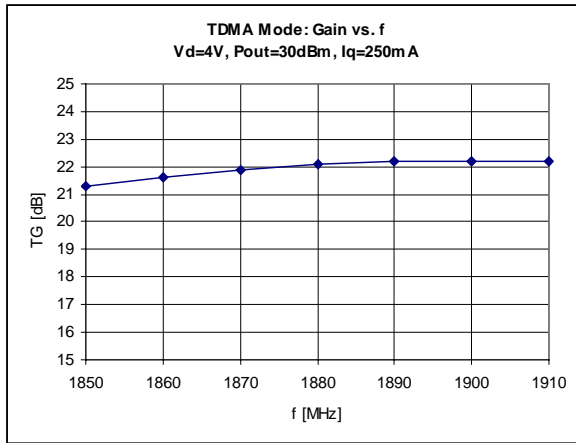

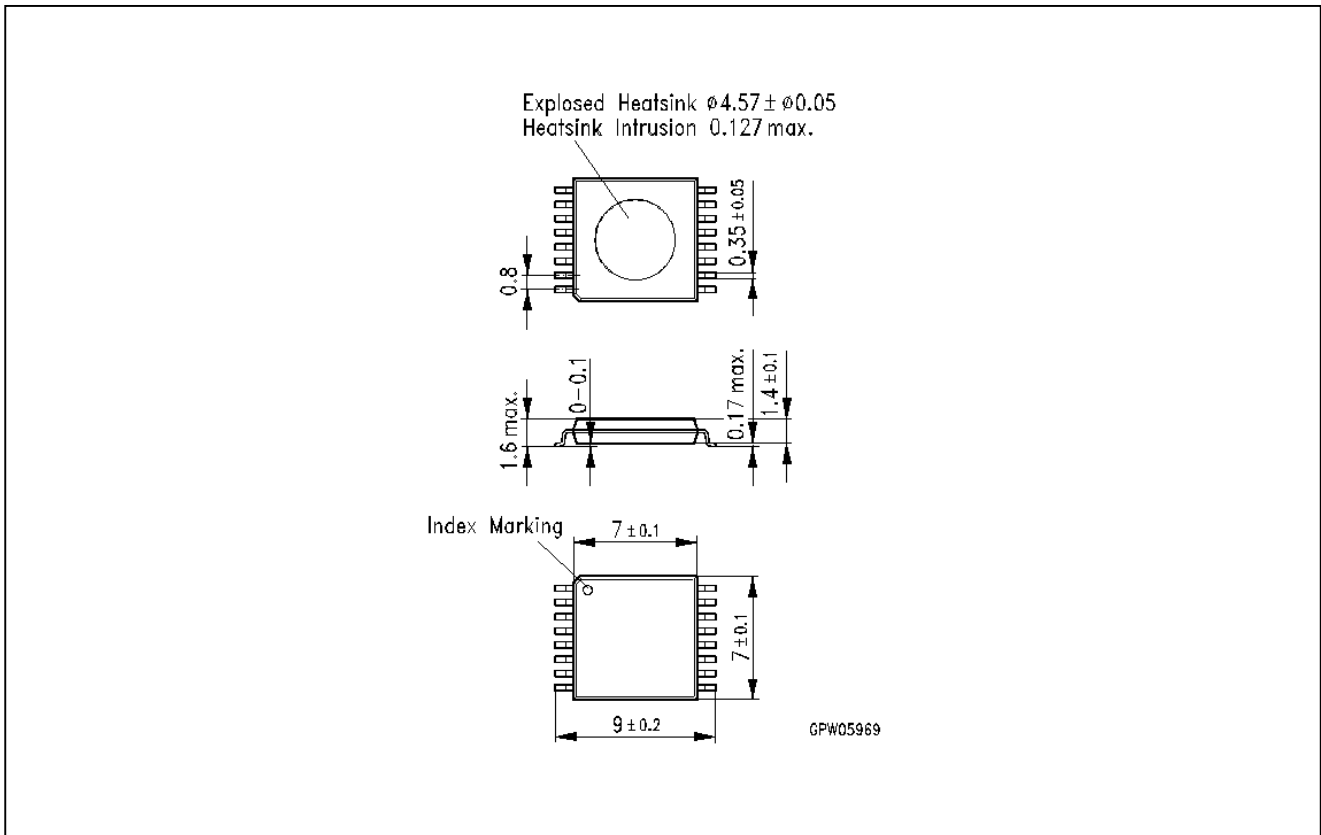

Published by Siemens AG, Bereich Bauelemente, Vertrieb, Produkt-Information, Balanstraße 73, D-81541 München

copyright Siemens AG 1996. All Rights Reserved

As far as patents or other rights of third parties are concerned, liability is only assumed for components per se, not for applications, processes and circuits implemented within components or assemblies.

The information describes the type of component and shall not be considered as assured characteristics.

Terms of delivery and rights to change design reserved.

For questions on technology, delivery and prices please contact the Offices of Semiconductor Group in Germany or the Siemens Companies and Representatives worldwide (see address list).

Due to technical requirements components may contain dangerous substances. For information on the type in question please contact your nearest Siemens Office, Semiconductor Group.

Siemens AG is an approved CECC manufacturer