

20-40GHz Variable Gain Amplifier

GaAs Monolithic Microwave IC

Description

The CHA2097a is a variable gain broadband three-stage monolithic amplifier. It is designed for a wide range of applications, from military to commercial communication systems. The backside of the chip is both RF and DC grounds. This helps simplify the assembly process.

The circuit is manufactured with a PM-HEMT process, 0.25µm gate length, via holes through the substrate, air bridges and electron beam gate lithography. It is available in chip form.

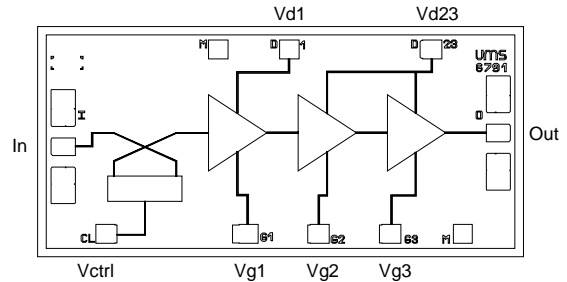

Main Features

- Broadband performances : 20-40GHz
- 14dBm output power (1dB gain comp.)
- 18dB ±1.5dB gain
- 10dB gain control range.
- Low DC power consumption, 140mA @ 3.5V
- Chip size : 2.04 X 0.97 X 0.10 mm

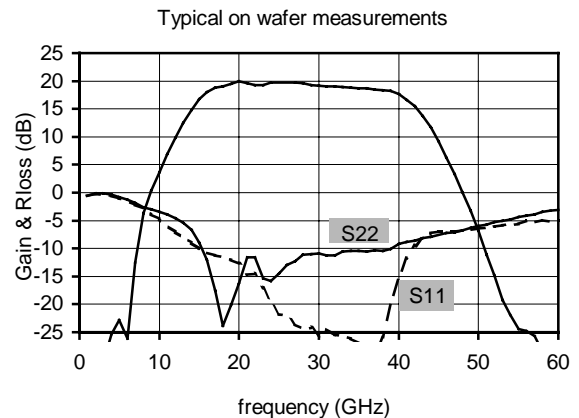

Main Characteristics

Tamb. = 25°C

Symbol	Parameter	Min	Typ	Max	Unit
Fop	Operating frequency range	20		40	GHz
G	Small signal gain	16	18		dB
Gctrl	Gain control range		10		dB
P1dB	Output power at 1dB gain compression	13	14		dBm
Id	Bias current		140	200	mA

ESD Protection : Electrostatic discharge sensitive device. Observe handling precautions !

Electrical Characteristics for Broadband Operation

Tamb = +25°C, Vd1,2,3 = 3.5V

Symbol	Parameter	Min	Typ	Max	Unit
Fop	Operating frequency range (1)	20		40	GHz
G	Small signal gain (1)	16	18		dB
ΔG	Small signal gain flatness (1)		±1.5		dB
Is	Reverse isolation (1)		40		dB
P1dB	Output power at 1dB gain compression (1)	13	14		dBm
P03	Output power at 3dB gain compression	15	16		dBm
VSWRin	Input VSWR (1)			3.0:1	
VSWRout	Output VSWR (1)			3.0:1	
Gctrl	Gain control dynamic		12		dB
Vdc	DC voltage Vd Vg Vctrl	-2.0 -2.0	3.5	4.0 0.4 0.4	V V V
Id	Bias current		140	200	mA

(1) These values are representative of on-wafer measurements that are made without bonding wires at the RF ports.

Absolute Maximum Ratings

Tamb. = 25°C (1)

Symbol	Parameter	Values	Unit
Vd	Drain bias voltage	4.0	V
Id	Drain bias current	200	mA
Vg	Gate bias voltage	-2.0 to +0.4	V
Ta	Operating temperature range	-40 to +85	°C
Tstg	Storage temperature range	-55 to +155	°C

(1) Operation of this device above anyone of these parameters may cause permanent damage.

Typical Scattering Parameters (On wafer Sij measurements):Bias Conditions: $V_d=3.5V$, $V_g=0V$, $V_{ctrl}=-1V$, $I_d=140mA$

F(GHz)	S11 dB	S11 /°	S12 dB	S12 /°	S21 dB	S21 /°	S22 dB	S22 /°
10	-4,75	-115,2	-67,47	-177,7	3,66	-94,8	-3,4	-177,9
11	-5,92	-124	-67,62	150,7	6,93	-125,4	-3,95	167,5
12	-6,95	-131	-66,42	148,4	9,91	-157,6	-4,6	152,2
13	-8,07	-137,6	-70,21	118,4	12,47	170,1	-5,43	135,1
14	-9	-142,7	-71,68	102,8	14,8	136,8	-6,68	115,1
15	-9,96	-147,7	-69,5	-77,6	16,79	101,8	-8,99	90,3
16	-10,75	-151,4	-71,34	-153,6	18,03	66,8	-12,02	64,8
17	-11,26	-154,7	-61,82	-169,2	18,79	31,6	-17,57	28,2
18	-11,52	-160,8	-58,85	171,5	19	0,7	-23,88	-12
19	-12,03	-170,5	-55,51	126,7	19,51	-29,1	-20,12	-71,4
20	-12,71	-179,1	-54,34	111,5	19,91	-57,6	-16,3	-97,4
21	-14,68	174,8	-50,54	51,9	19,56	-93,1	-10,26	-139,8
22	-14,55	168,3	-68,27	-0,3	19,32	-113,6	-11,59	-176,9
23	-17,06	154,2	-55,58	74,8	19,23	-134	-15,39	170,8
24	-19,6	155,1	-55,02	34,8	19,68	-161,4	-15,8	-174,6
25	-21,82	160,7	-54,34	25,3	19,69	172,4	-14,44	-170,8
26	-21,99	166	-52,57	4,1	19,71	147,7	-12,93	-176,7
27	-23,66	162,2	-53,35	-36,2	19,75	121,7	-12,25	174,8
28	-24,37	169	-55,75	-48,6	19,57	96	-11,11	169,8
29	-24,22	171,5	-53,54	-47,9	19,23	71,9	-10,96	156,3
30	-25,56	178,6	-56,09	-85,8	19,19	48,2	-10,95	149,1
31	-24,43	177,5	-52,89	-80,7	19,09	24,1	-11,22	142
32	-25,44	169,7	-51,25	-117,3	19,02	-0,4	-11,25	137
33	-25,52	171,3	-49,33	-147,8	18,95	-25,9	-10,52	130
34	-26,11	165,7	-50,85	-165,7	18,79	-50,8	-10,42	120,3
35	-26,98	157,4	-47,32	174,7	18,71	-76,2	-10,4	112,1
36	-28,03	132,1	-47,19	145,5	18,71	-102,2	-10,59	102,2
37	-29,59	80	-45,61	115	18,5	-130,4	-10,34	93
38	-25,97	10,7	-45,29	68,8	18,31	-158	-10,39	81,8
39	-19,91	-36,7	-48,48	57,1	18,2	172,1	-10,1	75,9
40	-15,11	-70	-47,05	65,8	17,69	139,1	-9,2	62,2
41	-11,72	-101	-45,42	28,8	16,63	105,7	-8,86	48,1
42	-9,51	-133,1	-46,37	-3,4	15,5	71,9	-8,56	35,7
43	-8,19	-167,2	-49,95	-13,7	13,76	37,9	-8,16	19,1
44	-7,23	160,6	-49,34	-29,7	11,68	4,6	-7,96	2,8
45	-6,98	127,9	-48,29	-64,6	9,12	-26,4	-7,6	-10,6
46	-7	95,8	-43,43	-46,4	6,31	-56	-7,27	-24,1
47	-6,99	64,6	-41,24	-68,1	3,32	-83,9	-7,08	-38,4
48	-6,78	34,2	-38,37	-97,4	0,15	-111,7	-6,78	-50,8
49	-6,66	7,2	-40,96	-138,5	-3,25	-137,9	-6,27	-62,1
50	-6,47	-18,1	-46,95	-70,4	-6,78	-160,6	-5,98	-75,1
51	-6,32	-40,8	-42,32	-101,2	-11,11	-178,6	-5,72	-83,4
52	-6,05	-60,5	-40,63	-176,6	-14,83	163,5	-5,3	-93,5
53	-5,89	-77,5	-48,84	171,4	-19,24	157,2	-5,1	-102,7
54	-5,71	-94,2	-61,19	111,7	-21,88	148,7	-4,8	-110,9
55	-5,58	-107,5	-56,96	103,7	-24,47	133,5	-4,35	-120,8
56	-5,1	-121,6	-55,14	166,4	-24,78	114,8	-4,18	-130,4
57	-5,23	-132,4	-50,04	30,3	-25,65	89,9	-3,86	-135,8
58	-4,98	-144,5	-54,03	-125,9	-28,47	60,3	-3,47	-145,5
59	-5,18	-155,1	-55,65	179,7	-30,93	30,8	-3,21	-153,3

Typical Scattering Parameters (On wafer Sij measurements):

Bias Conditions: Vd=3.5V, Vg=0V, Vctrl=-0.3V, Id=140mA

F(GHz)	S11 dB	S11 /°	S12 dB	S12 /°	S21 dB	S21 /°	S22 dB	S22 /°
10	-21,22	-127,3	-76,73	178,5	-11,95	-77,4	-3,39	-178
11	-21,29	-137,1	-78,25	152,7	-8,66	-105,2	-3,93	167,4
12	-21,49	-145,7	-73,34	145,3	-5,6	-134,7	-4,58	152
13	-21,84	-154	-77,33	154,5	-3	-164,1	-5,41	134,8
14	-22,04	-162,3	-80,66	144,3	-0,57	165,1	-6,66	114,6
15	-22,52	-169,6	-81,88	-119,4	1,48	132,5	-8,92	89,7
16	-23,04	-176,4	-73,48	178,9	2,82	99,7	-11,91	63,8
17	-23,85	176,4	-63,82	-174,9	3,65	66,3	-17,29	26,6
18	-24,42	170,9	-64	179,2	3,85	36,8	-23,56	-16,2
19	-24,63	166	-58,81	153	4,28	8,4	-20,1	-74,1
20	-25,23	161,6	-58,94	135,1	4,54	-17,9	-16,45	-99,5
21	-26,25	153,4	-56,1	60,4	4,29	-50,3	-10,67	-138,7
22	-27,04	152,8	-76,98	-105,4	3,55	-70,1	-11,7	-175,2
23	-27,88	146,8	-61,65	138,4	3,75	-88,5	-15,43	170
24	-29,52	142,3	-59,54	99,5	4,18	-112,8	-16,32	-173,1
25	-31,05	139	-57,85	87,5	4,17	-136,4	-14,56	-168,2
26	-33,21	137,1	-58,27	78	4,12	-158,7	-13,03	-174,9
27	-36,65	139,9	-58,68	57,7	4,14	177,6	-12,27	177
28	-37,81	150,3	-59,11	58,8	3,85	154,7	-11,04	171,7
29	-38,63	-179,8	-57,44	39	3,45	133,2	-10,84	157,6
30	-36,35	-146,1	-70,19	57,9	3,32	111,7	-10,88	149,5
31	-34,9	-140,8	-56	15,6	3,14	91,1	-11,32	142,3
32	-33,79	-133,8	-64,97	-22,2	3,07	69,5	-11,31	138,8
33	-30,34	-140,1	-61,29	-13,6	2,85	46,7	-10,47	131,1
34	-29,02	-137	-56,63	-17,7	2,53	25	-10,35	121,2
35	-28,15	-137,3	-63,3	-100,1	2,31	2,6	-10,38	112,8
36	-26,75	-145	-67,38	177,5	2,04	-20,2	-10,53	102,9
37	-25,56	-146,6	-63,38	84,1	1,53	-45,1	-10,35	92,6
38	-24,23	-152,1	-49,84	63,6	0,94	-68,2	-10,41	81,7
39	-23,27	-157,7	-63,61	-163,1	0,43	-93,6	-10,26	74,1
40	-22,17	-160,7	-55,7	170,1	-0,45	-121,1	-9,47	62
41	-21,72	-164,2	-58,1	57,2	-1,94	-151,6	-9,14	48,7
42	-21,71	-172,8	-57,64	35,3	-3,83	-179,8	-8,75	36,5
43	-20,6	-179,4	-56,99	73,1	-6,65	150,8	-8,31	20,2
44	-19,32	176,4	-55,62	49,1	-10,79	124	-8,02	3,8
45	-18,65	170,4	-55,06	-6,1	-17,23	103,1	-7,64	-9,7
46	-18,06	161,6	-45,05	-9,1	-29,13	124,9	-7,35	-23,8
47	-17,26	151,8	-41,22	-30,4	-21,01	-169,3	-7,14	-37,5
48	-16,91	143,5	-38,77	-88,4	-15,55	175,8	-6,86	-49,6
49	-16,53	130,1	-45,12	-127,4	-13,23	156,5	-6,31	-61,6
50	-13,58	131,6	-48,65	-58,6	-11,37	109,8	-6,04	-74,6
51	-12,71	121,7	-40,48	-80,3	-10,55	97,7	-5,78	-83,3
52	-11,82	108,4	-40,42	-148,9	-9,53	81,4	-5,29	-93,8
53	-11,71	92	-51,47	-147,8	-9,08	58,2	-5,17	-102,5
54	-11,55	80	-57,09	-105,6	-9,02	35	-4,83	-110,9
55	-11,82	65,9	-63,78	-147,1	-9,01	9,9	-4,42	-120,7
56	-12,85	54	-58,06	-172	-9,44	-21,2	-4,3	-130,1
57	-12,91	39,8	-52,98	106	-10,94	-55,8	-3,89	-136
58	-13,13	25,7	-55,61	-166,3	-13,87	-89,7	-3,55	-93,8
59	-13,73	15,8	-64,85	115,9	-18,07	-112,3	-3,24	-102,5

Typical On wafer measurements:

Tamb = +25°C

Gain and phase versus voltage control on CL pad :

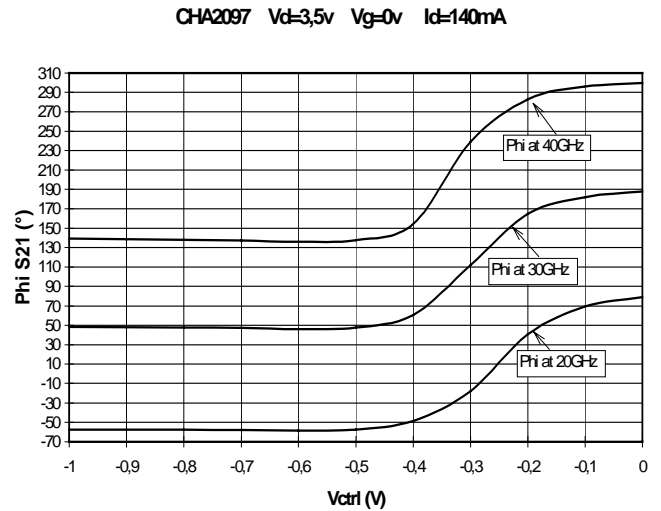
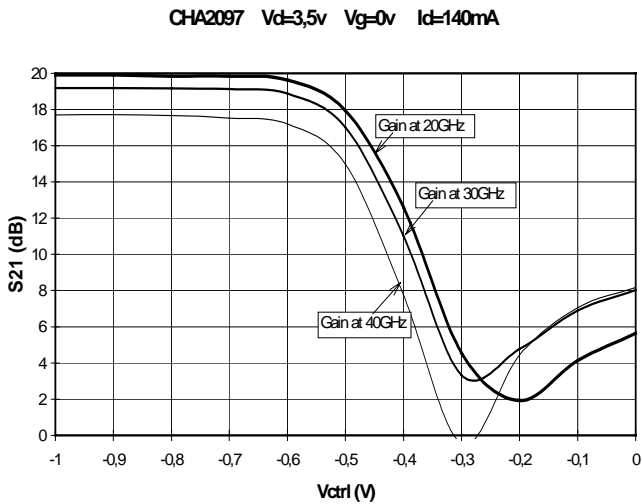

Sij parameter measurements versus frequency for 2 voltage control on CL pad:

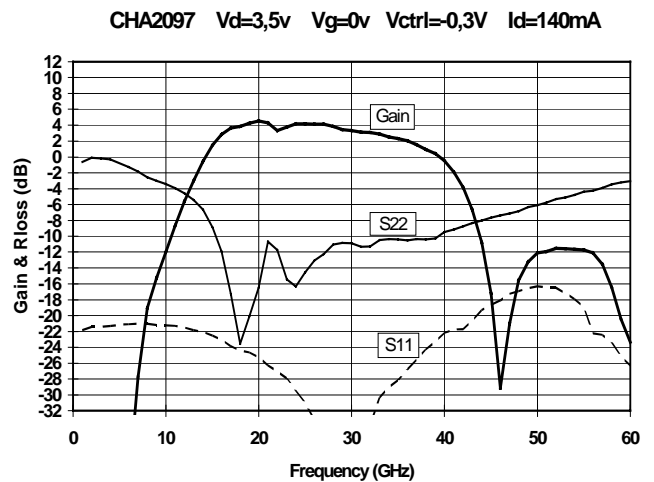
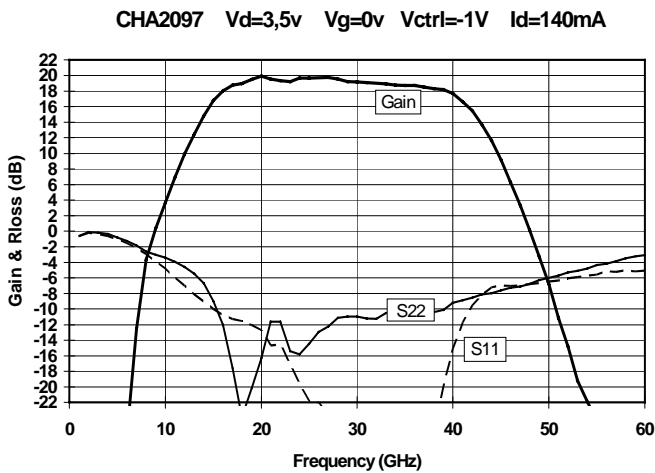

Chip Assembly and Mechanical Data

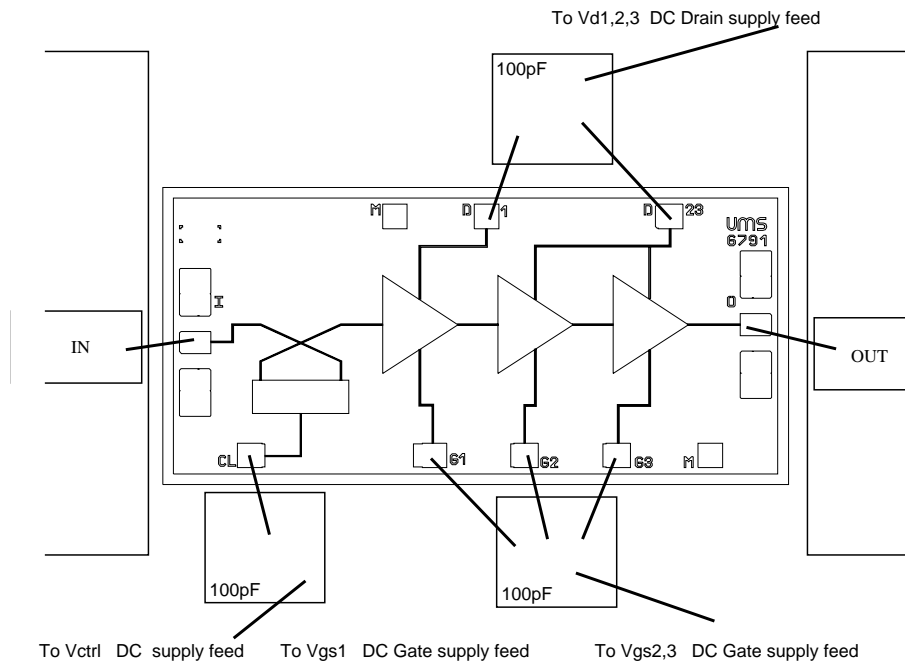

Note : Supply feed should be capacitively bypassed.

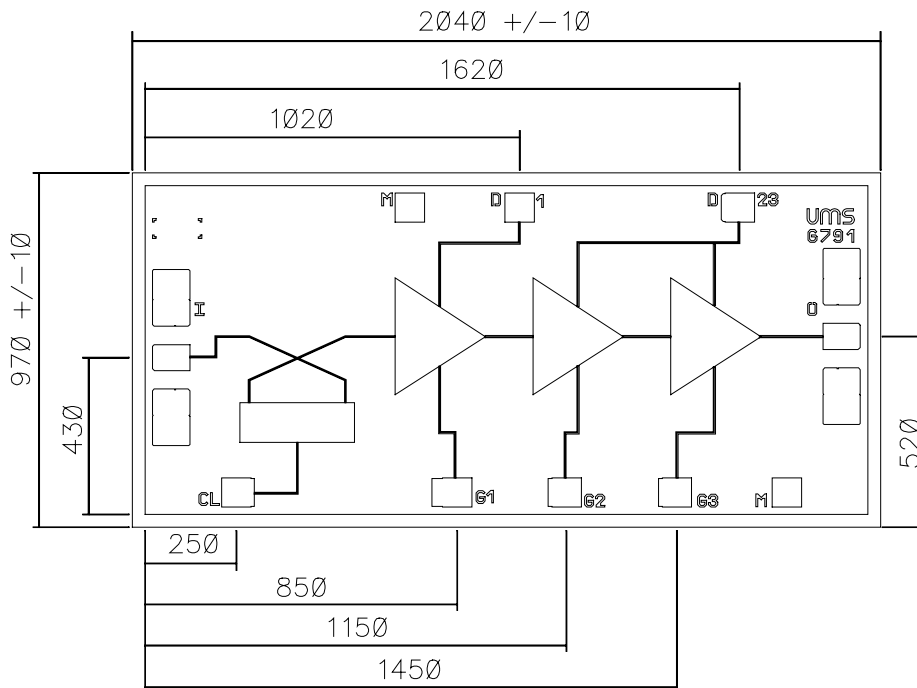

Bonding pad positions.

(Chip thickness : 100μm. All dimensions are in micrometers)

Typical Bias Tuning

The circuit schematic is given below :

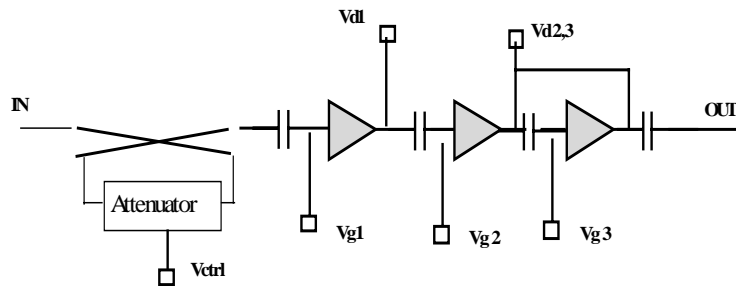

For gain control operation, The three drain biases are connected altogether. In a same way, all the gate biases are connected together at the same power supply, tuned to drive a small signal operating current of 140mA. A separate access to the gate voltages of each stages (Vg1,2,3) is provided for fine tuning of the stages regarding the application.

An additional pad is provided (Vctrl) to control the gain of the circuit, driving two cold transistors in attenuator arrangement.

Ordering Information

Chip form : CHA2097a99F/00

Information furnished is believed to be accurate and reliable. However **United Monolithic Semiconductors S.A.S.** assumes no responsibility for the consequences of use of such information nor for any infringement of patents or other rights of third parties which may result from its use. No license is granted by implication or otherwise under any patent or patent rights of **United Monolithic Semiconductors S.A.S.**. Specifications mentioned in this publication are subject to change without notice. This publication supersedes and replaces all information previously supplied. **United Monolithic Semiconductors S.A.S.** products are not authorised for use as critical components in life support devices or systems without express written approval from **United Monolithic Semiconductors S.A.S.**