

1A LOW DROPOUT LINEAR REGULATOR

GENERAL DESCRIPTION

The CJ1117 is a series of low dropout three-terminal regulators with a dropout of 1.15V at 1A output current.

The CJ1117 series provides current limiting and thermal shutdown. Its circuit includes a trimmed bandgap reference to assure output voltage accuracy to be within 1%. Current limit is trimmed to ensure specified output Current and controlled short-circuit current. On-chip thermal shutdown provides protection against any combination of overload and ambient temperature that would create excessive junction temperature.

The CJ1117 has an adjustable version, that can provide the output voltage from 1.25V to 5V with only 2 external resistors.

The CJ1117 series is available in the industry standard SOT-223,SOT-89,TO-220,TO-252 and TO-263 power packages.

FEATURES

- Low Dropout Voltage: 1.15V at 1A Output Current
- Trimmed Current Limit
- On-Chip Thermal Shutdown
- Three-Terminal Adjustable or Fixed 1.5V, 1.8V, 2.5V, 3.3V, 5V
- Operation junction Temperature: 0 °C to125°C

APPLICATIONS

- PC Motherboard
- LCD Monitor
- Graphic Card
- DVD-Video player
- NIC/Switch
- Telecom Modem
- ADSL Modem
- Printer and other peripheral Equipment

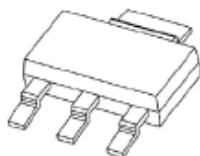

SOT-223

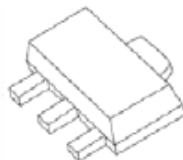

SOT-89-3L



TO-220

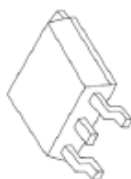

TO-252

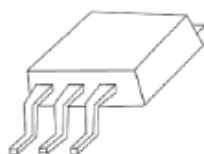

TO-263



TO-251

Figure 1. Package Types of CJ1117

1A LOW DROPOUT LINEAR REGULATOR

PIN CONFIGURATIONS

T Package
(SOT-223)

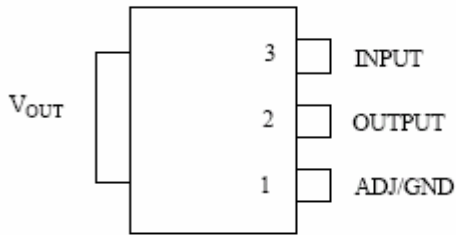

A Package
(SOT-89)

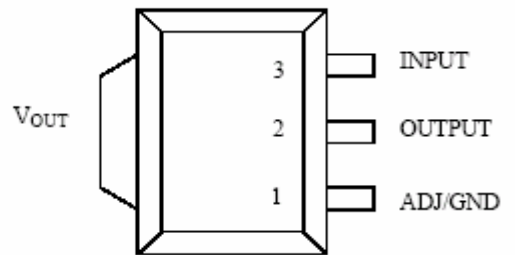

P Package
(TO-220)

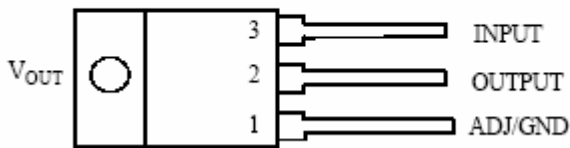

U Package
(TO-252)

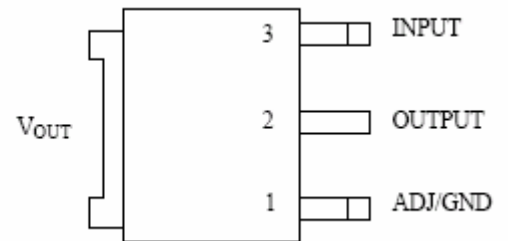

B Package
(TO-263)

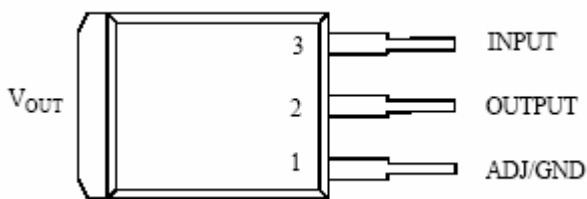

D Package
(TO-251)

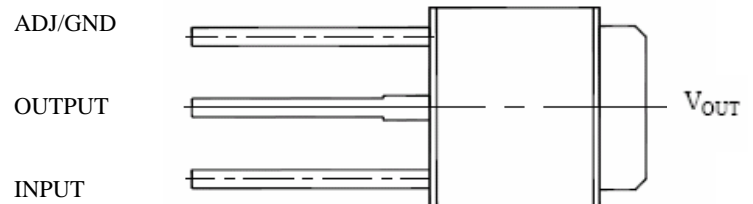

Figure 2. Pin Configurations of CJ1117

1A LOW DROPOUT LINEAR REGULATOR

FUNCTIONAL BLOCK DIAGRAM

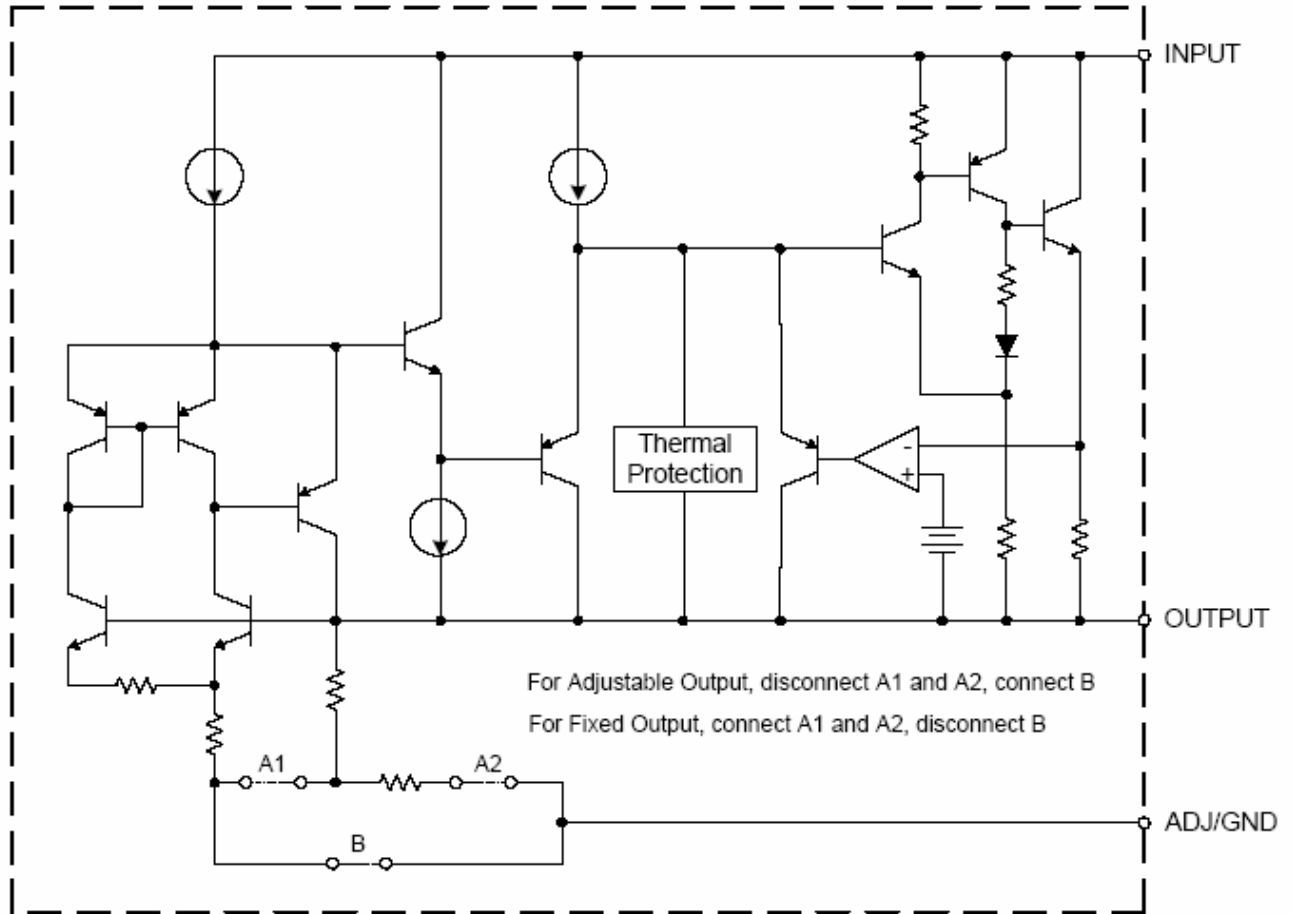

Figure 3. Functional Block Diagram of CJ1117

1A LOW DROPOUT LINEAR REGULATOR

ORDERING INFORMATION

Package	Operating Junction Temperature Range	Part Number
SOT-223	0 to 125°C	CJT1117-ADJ
		CJT1117-1.5
		CJT1117-1.8
		CJT1117-2.5
		CJT1117-3.3
		CJT1117-5.0
SOT-89	0 to 125°C	CJA1117-ADJ
		CJA1117-1.5
		CJA1117-1.8
		CJA1117-2.5
		CJA1117-3.3
		CJA1117-5.0
TO-220	0 to 125°C	CJP1117-ADJ
		CJP1117-1.5
		CJP1117-1.8
		CJP1117-2.5
		CJP1117-3.3
		CJP1117-5.0
TO-252	0 to 125°C	CJU1117-ADJ
		CJU1117-1.5
		CJU1117-1.8
		CJU1117-2.5
		CJU1117-3.3
		CJU1117-5.0
TO-263	0 to 125°C	CJB1117-ADJ
		CJB1117-1.5
		CJB1117-1.8
		CJB1117-2.5
		CJB1117-3.3
		CJB1117-5.0
TO-251	0 to 125°C	CJD1117-ADJ
		CJD1117-1.5
		CJD1117-1.8
		CJD1117-2.5
		CJD1117-3.3
		CJD1117-5.0

CJ X 1117- Z



Package
 T: SOT-223 U: TO-252
 A: SOT-89 B: TO-263
 P: TO-220 D: TO-251

ADJ: Adjustable Output
 1.5: Fixed Output 1.5V
 1.8: Fixed Output 1.8V
 2.5: Fixed Output 2.5V
 3.3: Fixed Output 3.3V
 5.0: Fixed Output 5.0V

1A LOW DROPOUT LINEAR REGULATOR

ABSOLUTE MAXIMUM RATINGS (NOTE 1)

Parameter	Value	Unit
V _{IN}	20	V
Maximum Junction Temperature	150	°C
Storage Temperature Range	-65 to 150	°C
Lead Temperature (Soldering, 10sec.)	300	°C
ESD (Machine Model)	600	V

Note 1: Stresses greater than those listed under "Absolute Maximum Ratings" may cause permanent damage to the device. These are stress ratings only, and functional of the device at these or any other conditions beyond those indicated under "Recommended Operating Conditions" is not implied. Exposure to "Absolute Maximum Ratings" for extended periods may affect device reliability.

RECOMMENDED OPERATING CONDITIONS

Parameter	Min	Max	Unit
V _{IN}		15	V
Operating Junction Temperature Range	0	125	°C

1A LOW DROPOUT LINEAR REGULATOR

ELECTRICAL CHARACTERISTICS

Operating Conditions: $V_{IN} \leq 10V$, $T_J = 25^\circ C$ unless otherwise specified.

Parameter	Conditions	Min	Typ	Max	Unit
Reference Voltage	CJ1117-ADJ $I_{OUT} = 10mA$, $V_{IN} - V_{OUT} = 2V$, $10mA \leq I_{OUT} \leq 1A$, $1.4V \leq V_{IN} - V_{OUT} \leq 8V$, $P \leq$ Maximum power Dissipation	1.238 1.225	1.250 1.250	1.262 1.270	V
Output Voltage	CJ1117-1.5, $I_{OUT} = 10mA$, $V_{IN} = 3.5V$ $10mA \leq I_{OUT} \leq 1A$, $3.0V \leq V_{IN} \leq 10V$	1.485 1.470	1.5 1.5	1.515 1.530	V
	CJ1117-1.8, $I_{OUT} = 10mA$, $V_{IN} = 3.8V$ $10mA \leq I_{OUT} \leq 1A$, $3.2V \leq V_{IN} \leq 10V$	1.782 1.746	1.8 1.8	1.818 1.854	V
	CJ1117-2.5, $I_{OUT} = 10mA$, $V_{IN} = 4.5V$ $10mA \leq I_{OUT} \leq 1A$, $3.9V \leq V_{IN} \leq 10V$	2.475 2.450	2.5 2.5	2.525 2.550	V
	CJ1117-3.3, $I_{OUT} = 10mA$, $V_{IN} = 5.0V$ $10mA \leq I_{OUT} \leq 1A$, $4.75V \leq V_{IN} \leq 10V$	3.267 3.235	3.3 3.3	3.333 3.365	V
	CJ1117-5.0, $I_{OUT} = 10mA$, $V_{IN} = 7.0V$ $10mA \leq I_{OUT} \leq 1A$, $6.5V \leq V_{IN} \leq 12V$	4.950 4.900	5.0 5.0	5.050 5.100	V
Line Regulation	CJ1117-ADJ $I_{OUT} = 10mA$, $1.5V \leq V_{IN} - V_{OUT} \leq 10V$		0.035	0.2	%
	CJ1117-1.5 $I_{OUT} = 10mA$, $1.5V \leq V_{IN} - V_{OUT} \leq 10V$		1	6	mV
	CJ1117-1.8 $I_{OUT} = 10mA$, $1.5V \leq V_{IN} - V_{OUT} \leq 10V$		1	6	mV
	CJ1117-2.5 $I_{OUT} = 10mA$, $1.5V \leq V_{IN} - V_{OUT} \leq 10V$		1	6	mV
	CJ1117-3.3 $I_{OUT} = 10mA$, $1.5V \leq V_{IN} - V_{OUT} \leq 10V$		1	6	mV
	CJ1117-5.0 $I_{OUT} = 10mA$, $1.5V \leq V_{IN} - V_{OUT} \leq 10V$		1	10	mV
Load Regulation	CJ1117-ADJ $V_{IN} - V_{OUT} = 2V$, $10mA \leq I_{OUT} \leq 1A$		0.2	0.4	%
	CJ1117-1.5 $V_{IN} - V_{OUT} = 2V$, $10mA \leq I_{OUT} \leq 1A$		1	10	mV
	CJ1117-1.8 $V_{IN} - V_{OUT} = 2V$, $10mA \leq I_{OUT} \leq 1A$		1	10	mV
	CJ1117-2.5 $V_{IN} - V_{OUT} = 2V$, $10mA \leq I_{OUT} \leq 1A$		1	10	mV
	CJ1117-3.3 $V_{IN} - V_{OUT} = 2V$, $10mA \leq I_{OUT} \leq 1A$		1	10	mV
	CJ1117-5.0 $V_{IN} - V_{OUT} = 2V$, $10mA \leq I_{OUT} \leq 1A$		1	15	mV

1A LOW DROPOUT LINEAR REGULATOR

ELECTRICAL CHARACTERISTICS (CONTINUED)

Operating Conditions: $V_{IN} \leq 10V$, $T_J = 25^\circ C$ unless otherwise specified.

Parameter	Conditions	Min	Typ	Max	Unit
Dropout Voltage	$\Delta V_{REF} = 1\%$, $I_{OUT} = 0.1A$		1.00	1.1	V
	$\Delta V_{REF} = 1\%$, $I_{OUT} = 0.5A$		1.08	1.18	V
	$\Delta V_{REF} = 1\%$, $I_{OUT} = 1.0A$		1.15	1.25	V
Current Limit	$V_{IN} - V_{OUT} = 2V$	1.25	1.35		A
Adjust Pin Current			60	120	μA
Adjust Pin Current Change	$1.4V \leq V_{IN} - V_{OUT} \leq 10V$, $10mA \leq I_{OUT} \leq 1A$		0.2	5	μA
Minimum Load Current (ADJ)	$1.5V \leq V_{IN} - V_{OUT} \leq 10V$ (ADJ only)		1.7	5	mA
Quiescent Current	$V_{IN} = V_{OUT} + 1.25V$		5	10	mA
Ripple Rejection	$f = 120Hz$, $C_{OUT} = 22\mu F$ Tantalum, $V_{IN} - V_{OUT} = 3V$, $I_{OUT} = 1A$	60	75		dB
Temperature Stability			0.5		%
Long-Term Stability	$T_A = 125^\circ C$, 1000hrs		0.3		%
RMS Output Noise (% of V_{OUT})	$T_A = 25^\circ C$, $10Hz \leq f \leq 10KHz$		0.003		%
Thermal Resistance, Junction to Case *	SOT-89 SOT-223 TO-252/251 TO-220 TO-263		25 15 10 4.5 4		$^\circ C/W$
Thermal Shutdown	Junction Temperature		150		$^\circ C$
Thermal Shutdown Hysteresis			25		$^\circ C$

* With package soldering to copper area over backside ground plane or internal power plane $R_{\theta JA}$ can vary from $46^\circ C/W$ to $>90^\circ C/W$ depending on mounting technique and the size of the copper area.

1A LOW DROPOUT LINEAR REGULATOR

Typical Applications

