



Low Capacitance Transient Voltage Suppressors / ESD Protectors

CM1218-C4

Features

- Low I/O capacitance at 7pF typical
- Four channels of ESD protection
- In-system ESD protection to $\pm 15\text{kV}$ contact discharge, per the IEC 61000-4-2 international standard
- Compact SMT package saves board space and facilitates layout in space-critical applications
- Each I/O pin can withstand over 1000 ESD strikes
- RoHS-compliant, lead-free

Note: For other versions of the CM1218, see the CM1218 datasheet or the CM1218-H4 datasheet.

Applications

- High-speed consumer electronic ports
- ESD protection of PC ports, including USB ports, serial ports, parallel ports, IEEE1394 ports, docking ports, proprietary ports, etc.
- Protection of interface ports or IC pins which are exposed to high ESD levels

Product Description

The CM1218-C4 device features transient voltage suppressor arrays that provide a very high level of protection for sensitive electronic components which may be subjected to electrostatic discharge (ESD).

All pins of the CM1218-C4 are rated to withstand $\pm 15\text{kV}$ ESD pulses using the IEC 61000-4-2 contact discharge method. Using the MIL-STD-883D (Method 3015) specification for Human Body Model (HBM) ESD, all pins are protected from contact discharges of greater than $\pm 30\text{kV}$.

The CM1218C4 is supplied in an SOT-553, RoHS-compliant, lead-free finished package.

Block Diagram

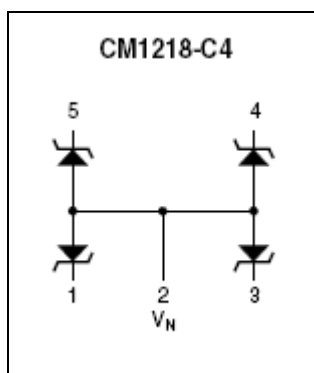

Pin Configurations

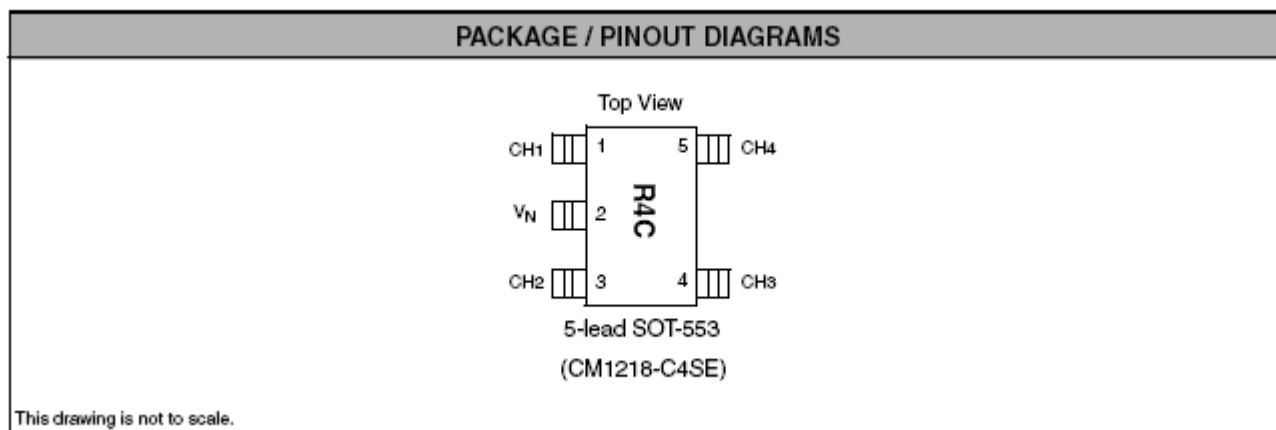

Pin Information

PIN DESCRIPTIONS

LEADS	NAME	DESCRIPTION
(Refer to package / pinout diagrams)	CHx	The cathode of the respective TVS diode, which should be connected to the node requiring transient voltage protection.
(Refer to package / pinout diagrams)	V _N	The anode of the TVS diodes.

Ordering Information

PART NUMBERING INFORMATION

Leads	Channels	Package	Lead-free Finish	
			Ordering Part Number	Part Marking
5	4	SOT-553	CM1218-C4SE	R4C

Notes : The maximum soldering reflow temperature for these packages is 260°C. Parts are shipped in tape and reel form unless otherwise specified.

CM1218-C4

Specifications

ABSOLUTE MAXIMUM RATINGS

PARAMETER	RATING	UNITS
Storage Temperature Range	-65 to +150	°C
Package Power Dissipation SOT-553	0.15	W

STANDARD OPERATING CONDITIONS

PARAMETER	RATING	UNITS
Operating Temperature	-40 to +85	°C

ELECTRICAL OPERATING CHARACTERISTICS

SYMBOL	PARAMETER	CONDITIONS	MIN	TYP	MAX	UNITS
C_{IN}	Channel Input Capacitance	$T_A = 25^\circ\text{C}$, 2.5VDC, 1MHz		7		pF
ΔC_{IN}	Differential Channel I/O to GND Capacitance	$T_A = 25^\circ\text{C}$, 2.5VDC, 1MHz		0.19		pF
V_{RSO}	Reverse Stand-off Voltage	$I_R = 10\mu\text{A}$, $T_A = 25^\circ\text{C}$	5.5			V
		$I_R = 1\text{mA}$, $T_A = 25^\circ\text{C}$	6.1			V
I_{LEAK}	Leakage Current	$V_{IN} = 5.0\text{VDC}$, $T_A = 25^\circ\text{C}$			1	μA
V_{SIG}	Small Signal Clamp Voltage Positive Clamp Negative Clamp	$I = 10\text{mA}$, $T_A = 25^\circ\text{C}$		6.8		V
		$I = -10\text{mA}$, $T_A = 25^\circ\text{C}$		-0.8		V
V_{ESD}	ESD Withstand Voltage Contact Discharge per IEC 61000-4-2 standard Human Body Model, MIL-STD-883, Method 3015	Notes 2 and 3; $T_A = 25^\circ\text{C}$	± 15			kV
		Notes 1 and 3; $T_A = 25^\circ\text{C}$	± 30			kV
R_D	Diode Dynamic Resistance Forward Conduction Reverse Conduction	$T_A = 25^\circ\text{C}$; Note 1		0.57		Ω
				1.36		Ω

Note 1: Human Body Model per MIL-STD-883, Method 3015, $C_{Discharge} = 100\text{pF}$, $R_{Discharge} = 1.5\text{K}\Omega$, V_N grounded.

Note 2: Standard IEC 61000-4-2 with $C_{Discharge} = 150\text{pF}$, $R_{Discharge} = 330\Omega$, V_N grounded.

Note 3: These measurements performed with no external capacitor on CH_x .

Performance Information

Diode Capacitance

Typical diode capacitance with respect to positive TVS cathode voltage (reverse voltage across the diode) is given in Diode Capacitance vs. Reverse Voltage .

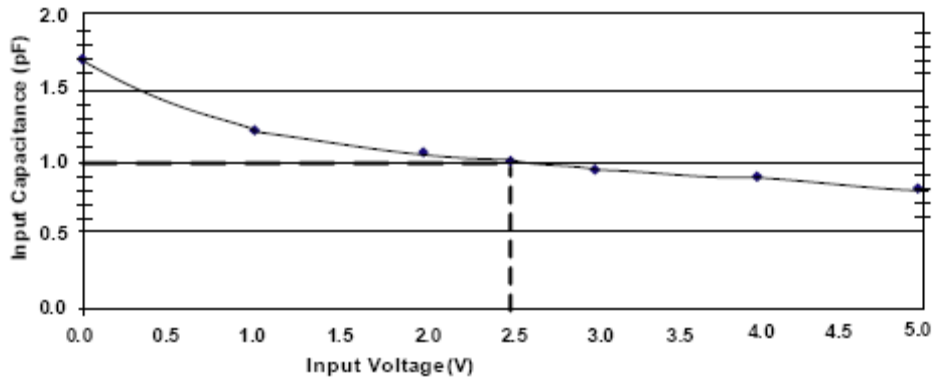
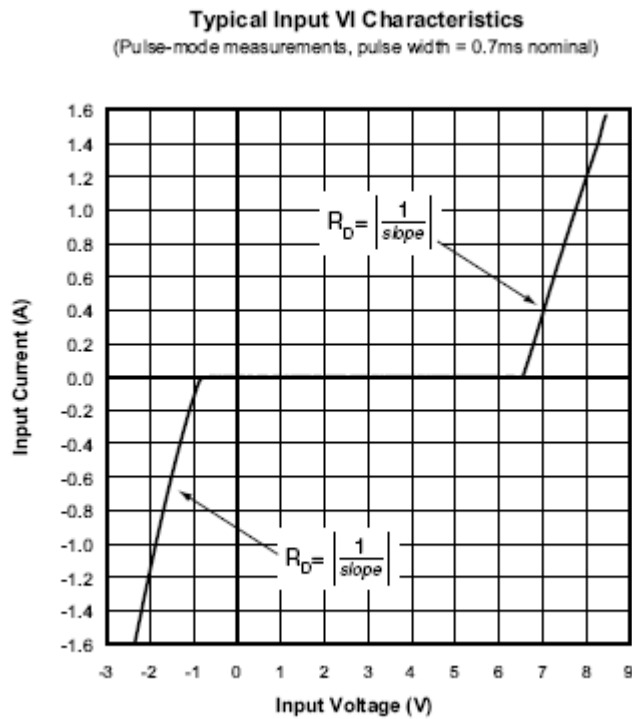

Figure 1. Diode Capacitance vs. Reverse Voltage

Typical High Current Diode Characteristics

Measurements are made in pulsed mode with a nominal pulse width of 0.7ms.



CM1218-C4

Mechanical Details

SOT-553 Mechanical Specifications

The CM1218-C4SE is supplied in a 5-pin SOT-553 package. Dimensions are presented below.

PACKAGE DIMENSIONS						
Package	SOT-553					
Leads	5					
Dim.	Millimeters			Inches		
	Min	Nom	Max	Min	Nom	Max
A	0.50	0.55	0.60	0.020	0.022	0.024
b	0.17	0.22	0.27	0.007	0.009	0.011
c	0.08	0.13	0.18	0.003	0.005	0.007
D	1.60 BSC			0.063 BSC		
E	1.60 BSC			0.063 BSC		
E1	1.20 BSC			0.047 BSC		
e	0.50 BSC			0.020 BSC		
e1	1.00 BSC			0.040 BSC		
L	0.20 BSC			0.008 BSC		
# per tape and reel	5000 pieces					
Controlling dimension: millimeters						

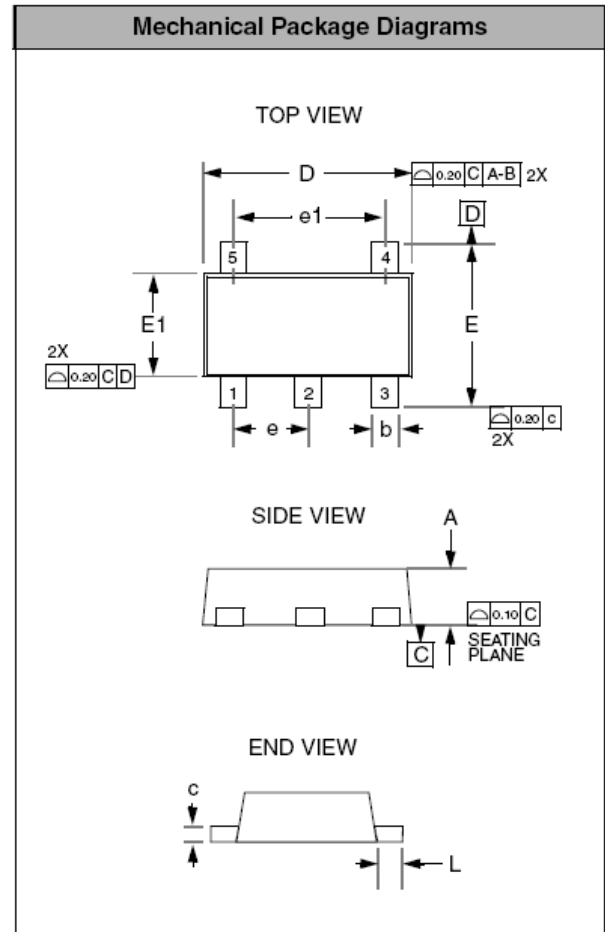

Package Dimensions for SOT-553

Tape and Reel Specifications

PART NUMBER	PACKAGE SIZE (mm)	POCKET SIZE (mm) $B_o \times A_o \times K_o$	TAPE WIDTH W	REEL DIAMETER	QTY PER REEL	P_o	P_1
CM1218-C4SE	1.60 X 1.60 X 0.55	1.78 X 1.78 X 0.690	8mm	178mm (7")	5000	4mm	4mm

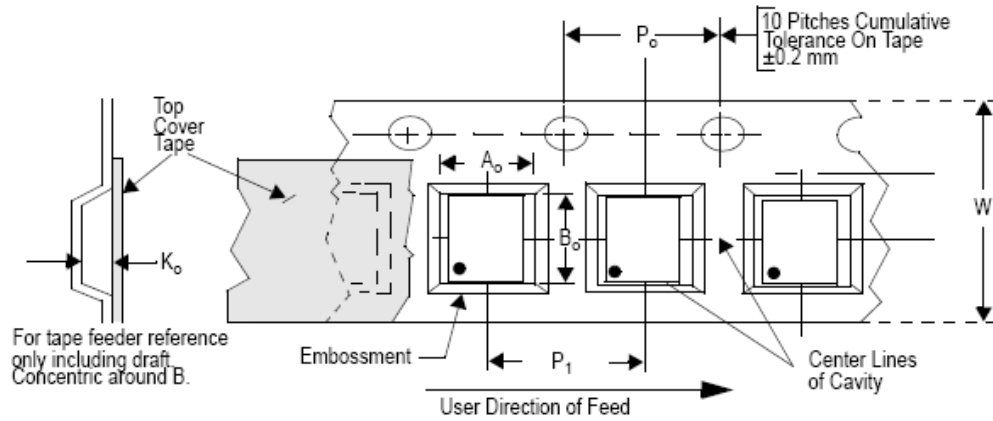

ON Semiconductor and  are registered trademarks of Semiconductor Components Industries, LLC (SCILLC). SCILLC reserves the right to make changes without further notice to any products herein. SCILLC makes no warranty, representation or guarantee regarding the suitability of its products for any particular purpose, nor does SCILLC assume any liability arising out of the application or use of any product or circuit, and specifically disclaims any and all liability, including without limitation special, consequential or incidental damages. "Typical" parameters which may be provided in SCILLC data sheets and/or specifications can and do vary in different applications and actual performance may vary over time. All operating parameters, including "Typicals" must be validated for each customer application by customer's technical experts. SCILLC does not convey any license under its patent rights nor the rights of others. SCILLC products are not designed, intended, or authorized for use as components in systems intended for surgical implant into the body, or other applications intended to support or sustain life, or for any other application in which the failure of the SCILLC product could create a situation where personal injury or death may occur. Should Buyer purchase or use SCILLC products for any such unintended or unauthorized application, Buyer shall indemnify and hold SCILLC and its officers, employees, subsidiaries, affiliates, and distributors harmless against all claims, costs, damages, and expenses, and reasonable attorney fees arising out of, directly or indirectly, any claim of personal injury or death associated with such unintended or unauthorized use, even if such claim alleges that SCILLC was negligent regarding the design or manufacture of the part. SCILLC is an Equal Opportunity/Affirmative Action Employer. This literature is subject to all applicable copyright laws and is not for resale in any manner.

PUBLICATION ORDERING INFORMATION

LITERATURE FULFILLMENT:

Literature Distribution Center for ON Semiconductor
P.O. Box 5163, Denver, Colorado 80217 USA
Phone: 303-675-2175 or 800-344-3860 Toll Free USA/Canada
Fax: 303-675-2176 or 800-344-3867 Toll Free USA/Canada
Email: orderlit@onsemi.com

N. American Technical Support: **800-282-9855**

Toll Free USA/Canada

Europe, Middle East and Africa Technical Support:
Phone: 421 33 790 2910
Japan Customer Focus Center
Phone: 81-3-5773-3850

ON Semiconductor Website: www.onsemi.com

Order Literature: <http://www.onsemi.com/orderlit>

For additional information, please contact your local Sales Representative