



4 and 8-Channel ESD Protection Arrays in CSP

CM1220

Features

- Four and eight channels of ESD protection
- *OptiGuard*[™] coated for improved reliability
- ±15kV ESD protection on each channel (IEC 61000-4-2 Level 4, contact discharge)
- ±30kV ESD protection on each channel (HBM)
- Chip Scale Package (CSP) features extremely low lead inductance for optimum ESD protection
- 5 bump, 0.960mm X 1.330mm CSP footprint for CM1220-04
- 10 bump, 1.960mm X 1.330mm CSP footprint for CM1220-08
- RoHS-compliant, lead-free version packaging

Applications

- LCD and camera data lines in mobile handsets
- I/O port protection for mobile handsets, notebook computers, PDAs, etc.
- Keypads and buttons
- Wireless handsets
- Handheld PCs/PDAs
- LCD and camera modules

Functional Description

The CM1220 ESD protection arrays are available in four and eight channel configurations. Each ESD channel features a nominal capacitance of 14pF making the devices ideal for protecting high speed I/O ports and LCD and camera data lines without significantly affecting signal integrity. The CM1220 integrates avalanche-type ESD diodes on every channel, providing a very high level of protection for sensitive electronic components that may be subjected to electrostatic discharge (ESD). These diodes safely dissipate ESD strikes of ±15kV, exceeding the maximum requirement of the IEC61000-4-2 international standard. Using the MIL-STD-883 (Method 3015) specification for Human Body Model (HBM) ESD, the CM1220 protect against contact discharges at greater than ±30kV.

These devices are particularly well-suited for portable electronics (e.g. wireless handsets, PDAs, notebook computers) because of their small package and easy-to-use pin assignments. In particular, the CM1220 is ideal for protecting high speed I/O ports and data and control lines for the LCD display and camera interface in mobile handsets.

The CM1220 incorporates CMD's *OptiGuard*[™] coating for improved reliability at assembly in a space-saving, low-profile Chip Scale Package.

Block Diagram

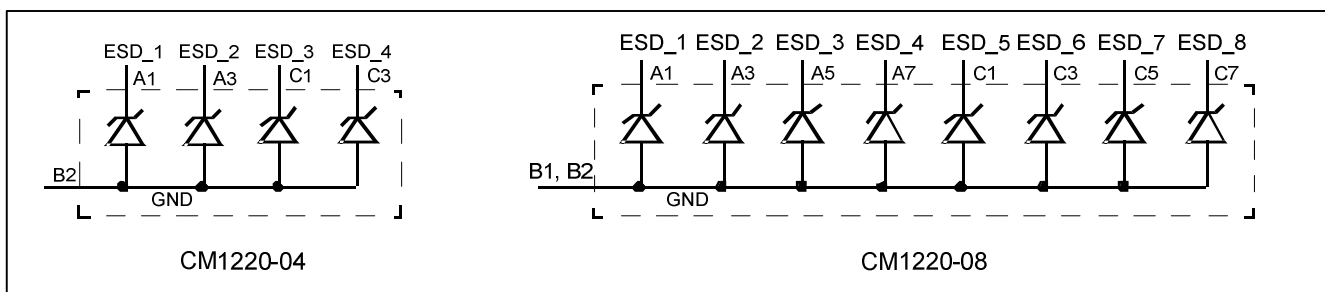

Pin Configurations

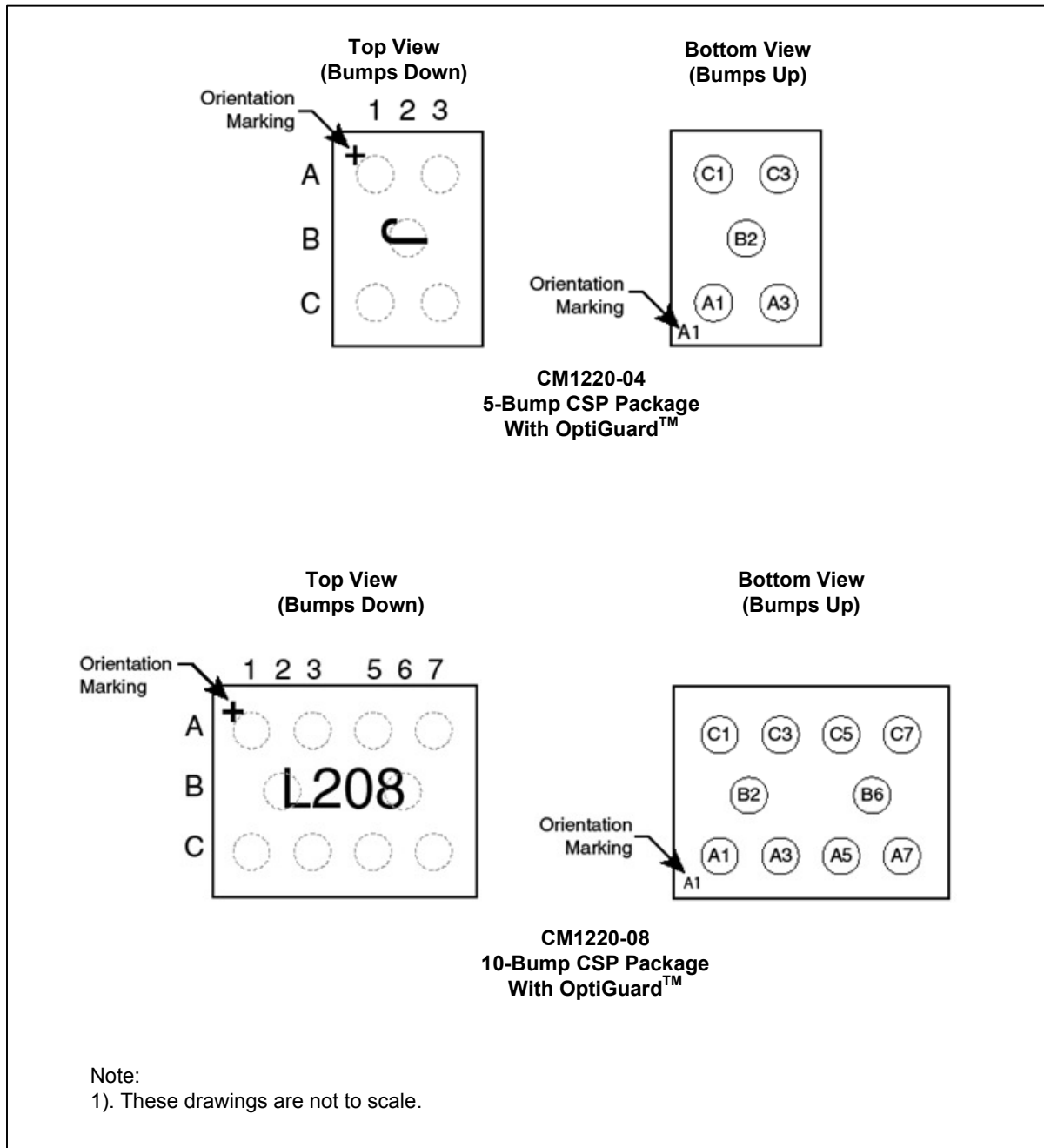

CM1220

Pin Descriptions

CM1220-08		CM1220-04		DESCRIPTION	CM1220-08		CM1220-04		DESCRIPTION
PINS	NAME	PINS	NAME		PINS	NAME	PINS	NAME	
A1	ESD1	A1	ESD1	ESD Channel	C1	ESD5	C1	ESD3	ESD Channel
A3	ESD2	A3	ESD2	ESD Channel	C3	ESD6	C3	ESD4	ESD Channel
A5	ESD3	–	–	ESD Channel	C5	ESD7	–	–	ESD Channel
A7	ESD4	–	–	ESD Channel	C7	ESD8	–	–	ESD Channel
B2	GND	B2	GND	Device Ground	B6	GND	–	–	Device Ground

Ordering Information

Bumps	Package	Ordering Part Number ¹	Part Marking
5	CSP	CM1220-04CP	J
10	CSP	CM1220-08CP	L208

Note 1: Parts are shipped in Tape and Reel form unless otherwise specified.

Absolute Maximum Ratings

PARAMETER	RATING	UNITS
Storage Temperature Range	-65 to +150	°C

Standard Operating Conditions

PARAMETER	RATING	UNITS
Operating Temperature Range	-40 to +85	°C

Electrical Operating Characteristics (see Note 1)

SYMBOL	PARAMETER	CONDITIONS	MIN	TYP	MAX	UNITS
C _{DIODE}	Diode (Channel) Capacitance	At 2.5VDC Reverse Bias, 1MHz, 30mVAC	11	14	17	pF
V _{DIODE}	Diode Standoff Voltage	I _{DIODE} = 10μA		6.0		V
I _{LEAK}	Diode Leakage Current	V _{IN} = +3.3V (reverse bias voltage)		0.1	1	μA
V _{SIG}	Signal Clamp Voltage Positive Clamp Negative Clamp	I _{DIODE} = 10mA	5.6 -1.5	6.8 -0.8	9.0 -0.4	V V
V _{ESD}	In-system ESD Withstand Voltage a) Human Body Model, MIL-STD-883, Method 3015 b) Contact Discharge per IEC 61000-4-2	Note 2	±30 ±15			kV kV
R _{DYN}	Dynamic Resistance Positive Negative			2.3 0.9		Ω Ω

Note 1: T_A=25 °C unless otherwise specified.

Note 2: ESD applied to input and output pins with respect to GND, one at a time. Unused pins are left open.

Performance Information

Diode Characteristics (nominal conditions unless specified otherwise)

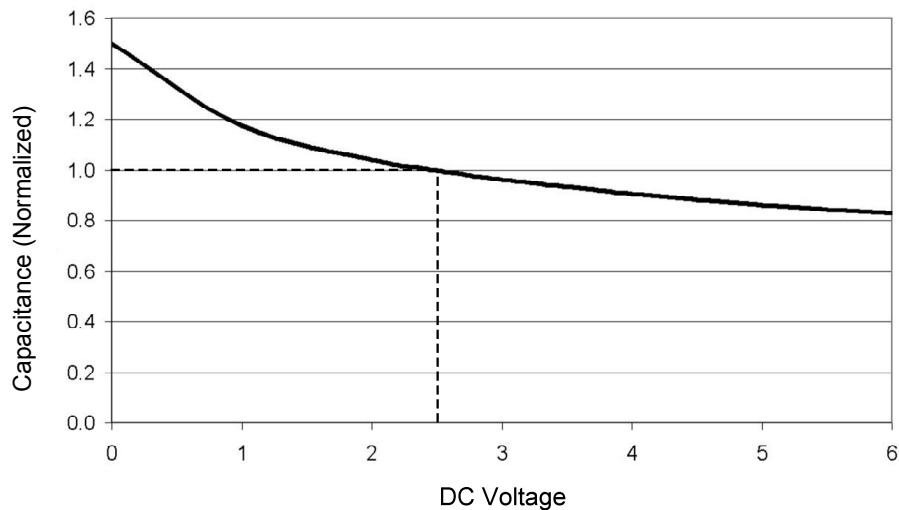

Figure 1. Insertion Loss Vs. Frequency (0V Bias)

CM1220

Application Information

PARAMETER	VALUE
Pad Size on PCB	0.240mm
Pad Shape	Round
Pad Definition	Non-Solder Mask defined pads
Solder Mask Opening	0.290mm Round
Solder Stencil Thickness	0.125mm - 0.150mm
Solder Stencil Aperture Opening (laser cut, 5% tapered walls)	0.300mm Round
Solder Flux Ratio	50/50 by volume
Solder Paste Type	No Clean
Pad Protective Finish	OSP (Entek Cu Plus 106A)
Tolerance — Edge To Corner Ball	$\pm 50\mu\text{m}$
Solder Ball Side Coplanarity	$\pm 20\mu\text{m}$
Maximum Dwell Time Above Liquidous (183°C)	60 seconds
Maximum Soldering Temperature for Lead-free Devices using a Lead-free Solder Paste	260°C

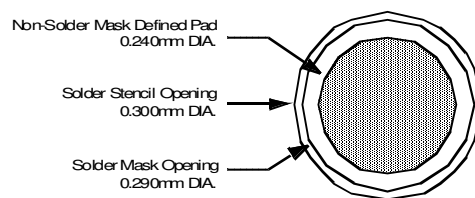

Figure 2. Recommended Non-Solder Mask Defined Pad Illustration

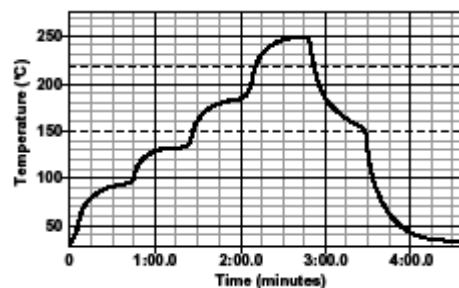

Figure 3. Lead-free (SnAgCu) Solder Ball Reflow Profile

Mechanical Specifications

The CM1220 is supplied in custom Chip Scale Packages (CSP) depending on the channel count. Dimensions for these packages are presented in the following pages.

CM1220-04CP Mechanical Specifications

Package Specifications						
Package	Custom CSP					
Bumps	5					
Dim	Millimeters			Inches		
	Min	Nom	Max	Min	Nom	Max
A1	0.915	0.960	1.005	0.0360	0.0378	0.0396
A2	1.285	1.330	1.375	0.0506	0.0524	0.0541
B1	0.495	0.500	0.505	0.0195	0.0197	0.0199
B2	0.245	0.250	0.255	0.0096	0.0098	0.0100
B3	0.430	0.435	0.440	0.0169	0.0171	0.0173
B4	0.430	0.435	0.440	0.0169	0.0171	0.0173
C1	0.180	0.230	0.280	0.0071	0.0091	0.0110
C2	0.180	0.230	0.280	0.0071	0.0091	0.0110
D1	0.575	0.644	0.714	0.0226	0.0254	0.0281
D2	0.368	0.419	0.470	0.0145	0.0165	0.0185
# per tape and reel	3500 pieces					
Controlling dimension: millimeters						

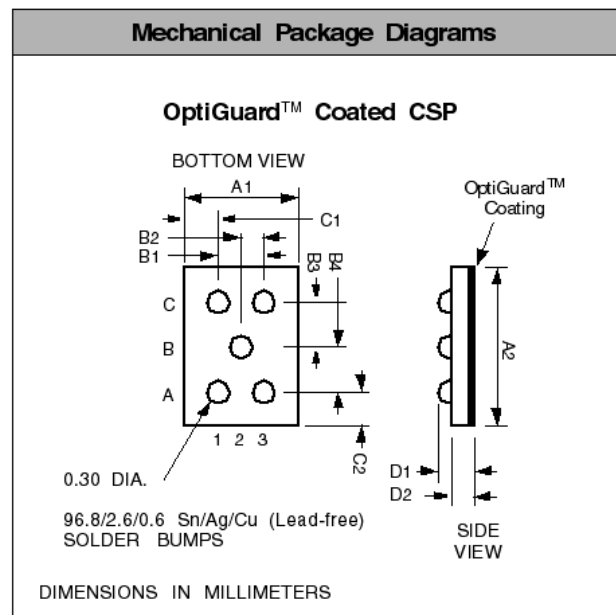

Package Dimensions for CM1220-04CP Chip Scale Package

CM1220

CSP Tape and Reel Specifications

PART NUMBER	CHIP SIZE (mm)	POCKET SIZE (mm) $B_0 \times A_0 \times K_0$	TAPE WIDTH W	REEL DIAMETER	QTY PER REEL	P_0	P_1
CM1220-04	1.33 X 0.96 X 0.644	1.42 X 1.07 X 0.740	8mm	178mm (7")	3500	4mm	4mm

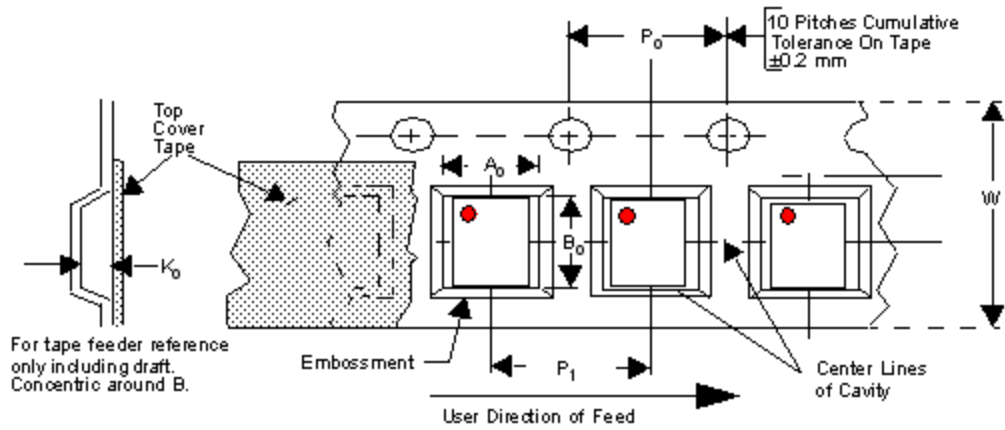

CM1220-08CP Mechanical Specifications

Package Specifications						
Package	Custom CSP					
Bumps	10					
Dim	Millimeters			Inches		
	Min	Nom	Max	Min	Nom	Max
A1	1.915	1.960	2.005	0.0754	0.0772	0.0789
A2	1.285	1.330	1.375	0.0506	0.0524	0.0541
B1	0.495	0.500	0.505	0.0195	0.0197	0.0199
B2	0.245	0.250	0.255	0.0096	0.0098	0.0100
B3	0.430	0.435	0.440	0.0169	0.0171	0.0173
B4	0.430	0.435	0.440	0.0169	0.0171	0.0173
C1	0.180	0.230	0.280	0.0071	0.0091	0.0110
C2	0.180	0.230	0.280	0.0071	0.0091	0.0110
D1	0.575	0.644	0.714	0.0226	0.0254	0.0281
D2	0.368	0.419	0.470	0.0145	0.0165	0.0185
# per tape and reel	3500 pieces					
Controlling dimension: millimeters						

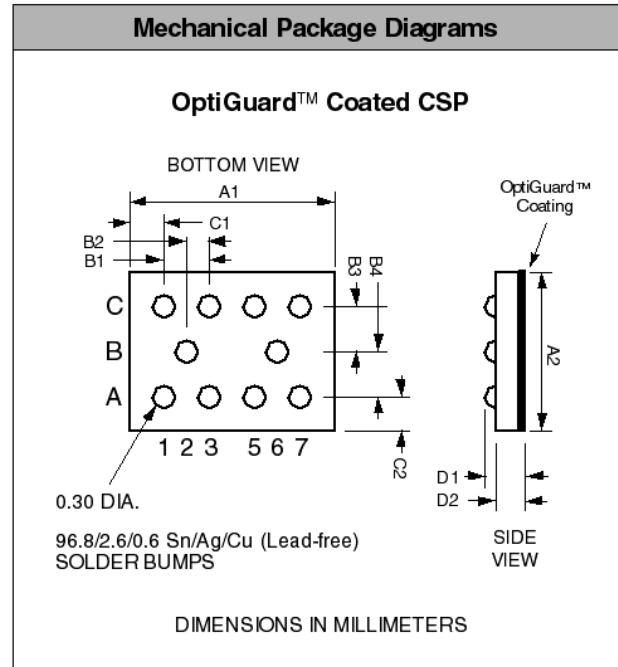



Package Dimensions for CM1220-08CP Chip Scale Package

CM1220

CSP Tape and Reel Specifications

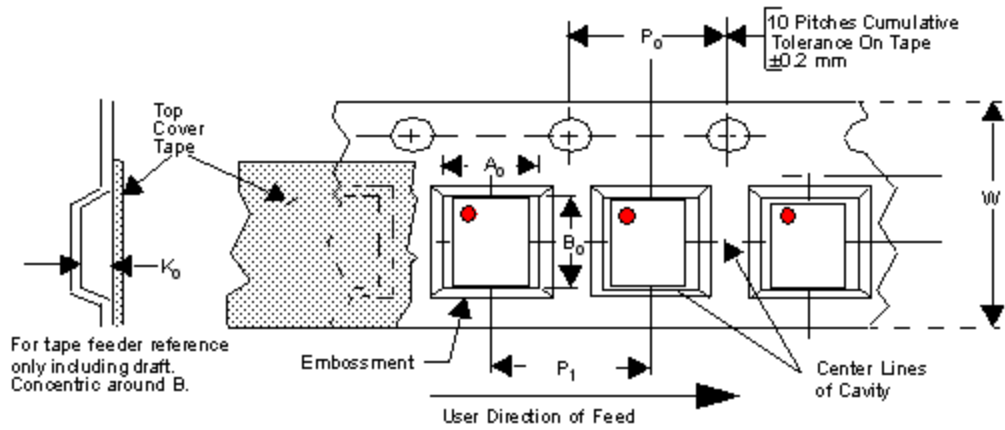
PART NUMBER	CHIP SIZE (mm)	POCKET SIZE (mm) $B_0 \times A_0 \times K_0$	TAPE WIDTH W	REEL DIAMETER	QTY PER REEL	P_0	P_1
CM1220-08	1.96 X 1.33 X 0.644	2.08 X 1.45 X 0.740	8mm	178mm (7")	3500	4mm	4mm



ON Semiconductor and  are registered trademarks of Semiconductor Components Industries, LLC (SCILLC). SCILLC reserves the right to make changes without further notice to any products herein. SCILLC makes no warranty, representation or guarantee regarding the suitability of its products for any particular purpose, nor does SCILLC assume any liability arising out of the application or use of any product or circuit, and specifically disclaims any and all liability, including without limitation special, consequential or incidental damages. "Typical" parameters which may be provided in SCILLC data sheets and/or specifications can and do vary in different applications and actual performance may vary over time. All operating parameters, including "Typicals" must be validated for each customer application by customer's technical experts. SCILLC does not convey any license under its patent rights nor the rights of others. SCILLC products are not designed, intended, or authorized for use as components in systems intended for surgical implant into the body, or other applications intended to support or sustain life, or for any other application in which the failure of the SCILLC product could create a situation where personal injury or death may occur. Should Buyer purchase or use SCILLC products for any such unintended or unauthorized application, Buyer shall indemnify and hold SCILLC and its officers, employees, subsidiaries, affiliates, and distributors harmless against all claims, costs, damages, and expenses, and reasonable attorney fees arising out of, directly or indirectly, any claim of personal injury or death associated with such unintended or unauthorized use, even if such claim alleges that SCILLC was negligent regarding the design or manufacture of the part. SCILLC is an Equal Opportunity/Affirmative Action Employer. This literature is subject to all applicable copyright laws and is not for resale in any manner.

PUBLICATION ORDERING INFORMATION

LITERATURE FULFILLMENT:

Literature Distribution Center for ON Semiconductor
P.O. Box 5163, Denver, Colorado 80217 USA
Phone: 303-675-2175 or 800-344-3860 Toll Free USA/Canada
Fax: 303-675-2176 or 800-344-3867 Toll Free USA/Canada
Email: orderlit@onsemi.com

N. American Technical Support: 800-282-9855
Toll Free USA/Canada
Europe, Middle East and Africa Technical Support:
Phone: 421 33 790 2910
Japan Customer Focus Center
Phone: 81-3-5773-3850

ON Semiconductor website: www.onsemi.com
Order Literature: <http://www.onsemi.com/orderlit>
For additional information, please contact your local Sales Representative