

LCD and Camera EMI Filter Array with ESD Protection

Features

- Six and eight channels of EMI filtering with integrated ESD protection
- Pi-style EMI filters in a capacitor-resistor-capacitor (C-R-C) network
- $\pm 15\text{kV}$ ESD protection on each channel (IEC 61000-4-2 Level 4, contact discharge)
- $\pm 30\text{kV}$ ESD protection on each channel (HBM)
- Greater than 35dB attenuation (typical) at 1 GHz
- TDFN package with 0.50mm lead pitch:
 - 6-ch. = 12-lead TDFN
 - 8-ch. = 16-lead TDFN
- Tiny TDFN package size:
 - 12-lead: 3.0mm x 1.35mm (two styles)
 - 16-lead: 4.0mm x 1.60mm
- Increased robustness against vertical impacts during manufacturing process
- Lead-free finishing

Applications

- LCD and Camera data lines in mobile handsets
- I/O port protection for mobile handsets, notebook computers, PDAs etc.
- EMI filtering for data ports in cell phones, PDAs or notebook computers.
- Wireless handsets
- Handheld PCs/PDAs
- LCD and camera modules

Product Description

The CM1409 is a family of pi-style EMI filter arrays with ESD protection, which integrates six and eight filters (C-R-C) in small form factor TDFN 0.50mm pitch packages. The CM1409 has component values of 15pF-100 Ω -15pF per channel. The CM1409 has a cut-off frequency of 110MHz and can be used in applications with data rates up to 44Mbps. The parts include ESD diodes on every pin, which provide a very high level of protection for sensitive electronic components that may be subjected to electrostatic discharge (ESD). The ESD protection diodes safely dissipate ESD strikes of $\pm 15\text{kV}$, well beyond the maximum requirement of the IEC61000-4-2 international standard. Using the MIL-STD-883 (Method 3015) specification for Human Body Model (HBM) ESD, the pins are protected for contact discharges at greater than $\pm 30\text{kV}$.

These devices are particularly well-suited for portable electronics (e.g. wireless handsets, PDAs, notebook computers) because of their small package and easy-to-use pin assignments. In particular, the CM1409 is ideal for EMI filtering and protecting data and control lines for the I/O data ports, LCD display and camera interface in mobile handsets.

The CM1409 is housed in space-saving, low-profile 12- and 16-lead TDFN packages with a 0.50mm pitch and is available with lead-free finishing.

Electrical Schematic

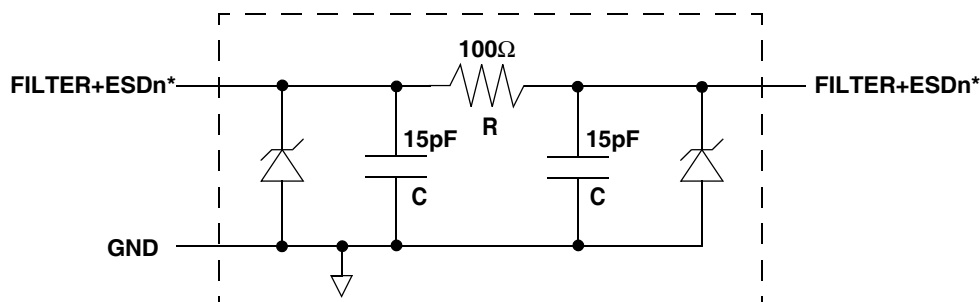

1 of 6 or 8 EMI/RFI + ESD Channels

* See Package/Pinout Diagram for expanded pin information.

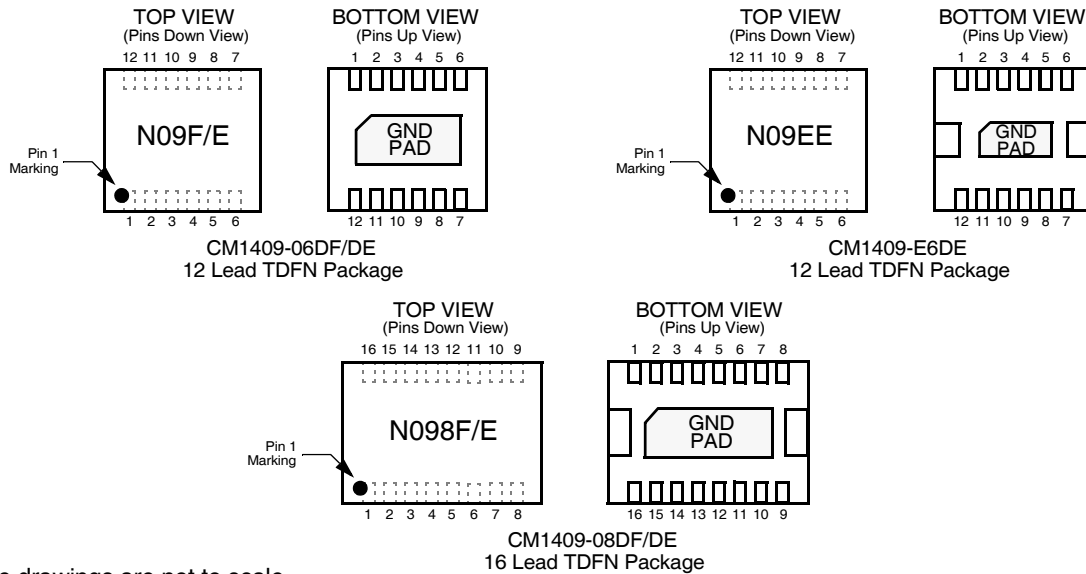
PACKAGE / PINOUT DIAGRAMS

PIN DESCRIPTIONS

DEVICE PIN(s)		NAME	DESCRIPTION	DEVICE PIN(s)		NAME	DESCRIPTION
-06	-08			-06	-08		
1	1	FILTER1	Filter + ESD Channel 1	12	16	FILTER1	Filter + ESD Channel 1
2	2	FILTER2	Filter + ESD Channel 2	11	15	FILTER2	Filter + ESD Channel 2
3	3	FILTER3	Filter + ESD Channel 3	10	14	FILTER3	Filter + ESD Channel 3
4	4	FILTER4	Filter + ESD Channel 4	9	13	FILTER4	Filter + ESD Channel 4
5	5	FILTER5	Filter + ESD Channel 5	8	12	FILTER5	Filter + ESD Channel 5
6	6	FILTER6	Filter + ESD Channel 6	7	11	FILTER6	Filter + ESD Channel 6
	7	FILTER7	Filter + ESD Channel 7		10	FILTER7	Filter + ESD Channel 7
	8	FILTER8	Filter + ESD Channel 8		9	FILTER8	Filter + ESD Channel 8
GND PAD		GND	Device Ground				

Ordering Information
PART NUMBERING INFORMATION

Pins	Package	Standard Finish		Lead-free Finish	
		Ordering Part Number ¹	Part Marking	Ordering Part Number ¹	Part Marking
12	TDFN-12	-	-	CM1409-E6DE	N09EE
12	TDFN-12	CM1409-06DF	N09F	CM1409-06DE	N09E
16	TDFN-16	CM1409-08DF	N098F	CM1409-08DE	N098E

Note 1: Parts are shipped in Tape & Reel form unless otherwise specified.

Specifications

ABSOLUTE MAXIMUM RATINGS

PARAMETER	RATING	UNITS
Storage Temperature Range	-65 to +150	°C
DC Power per Resistor	100	mW
DC Package Power Rating	500	mW

STANDARD OPERATING CONDITIONS

PARAMETER	RATING	UNITS
Operating Temperature Range	-40 to +85	°C

ELECTRICAL OPERATING CHARACTERISTICS (SEE NOTE1)

SYMBOL	PARAMETER	CONDITIONS	MIN	TYP	MAX	UNITS
R	Resistance		80	100	120	Ω
C _{TOTAL}	Total Channel Capacitance	At 2.5VDC Reverse Bias, 1MHz, 30mVAC	24	30	36	pF
C	Capacitance C ₁	At 2.5VDC Reverse Bias, 1MHz, 30mVAC	12	15	18	pF
V _{DIODE}	Standoff Voltage	I _{DIODE} =10μA		6.0		V
I _{LEAK}	Diode Leakage Current (reverse bias)	V _{DIODE} =+3.3V		0.1	1.0	μA
V _{SIG}	Signal Clamp Voltage Positive Clamp Negative Clamp	I _{LOAD} = 10mA I _{LOAD} = -10mA	5.6 -1.5	6.8 -0.8	9.0 -0.4	V V
V _{ESD}	In-system ESD Withstand Voltage a) Human Body Model, MIL-STD-883, Method 3015 b) Contact Discharge per IEC 61000-4-2 Level 4	Notes 2 and 3	±30 ±15			kV kV
R _{DYN}	Dynamic Resistance Positive Negative			2.3 0.9		Ω Ω
f _C	Cut-off Frequency Z _{SOURCE} =50Ω, Z _{LOAD} =50Ω	Channel R = 100Ω, Channel C = 15pF		110		MHz
A _{1GHz}	Absolute Attenuation @ 1GHz from 0dB Level	Z _{SOURCE} = 50Ω, Z _{LOAD} = 50Ω, DC Bias = 0V; Notes 1, 4 and 5		35		dB
A _{800MHz - 6GHz}	Absolute Attenuation @ 800MHz to 6GHz from 0dB Level	Z _{SOURCE} = 50Ω, Z _{LOAD} = 50Ω, DC Bias = 0V; Notes 1, 4 and 5		30		dB

Note 1: T_A=25°C unless otherwise specified.

Note 2: ESD applied to input and output pins with respect to GND, one at a time.

Note 3: These parameters are guaranteed by design and characterization.

Note 4: Attenuation / RF curves characterized by a network analyzer using microprobes.

Note 5: These parameters are NOT guaranteed by design, characterization and production.

Performance Information

Typical EMI Filter Performance ($T_A=25^\circ\text{C}$, DC Bias=0V, 50 Ohm Environment)

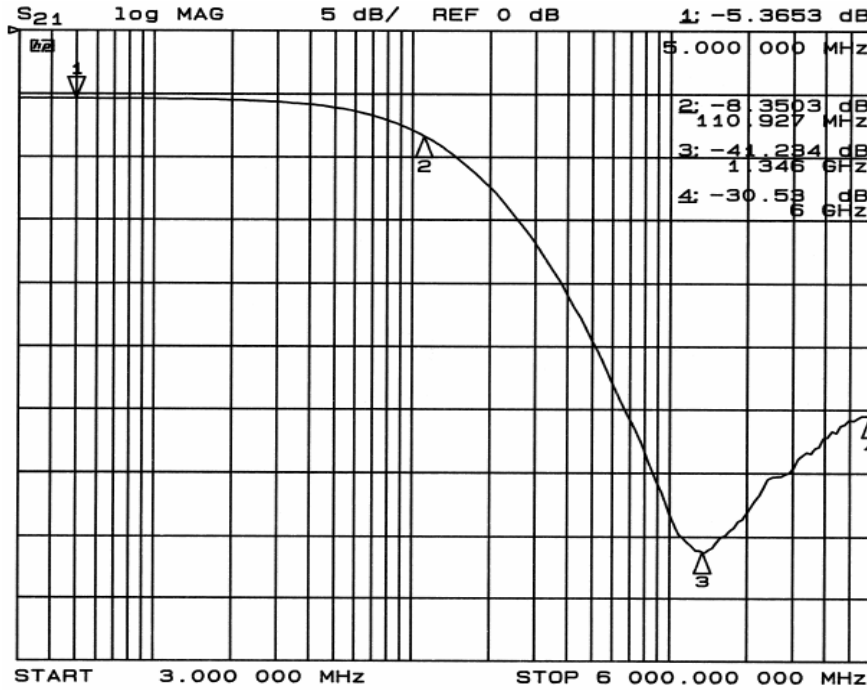

Figure 1. Insertion Loss vs. Frequency (Filter Input to GND)

Typical Diode Capacitance vs. Input Voltage

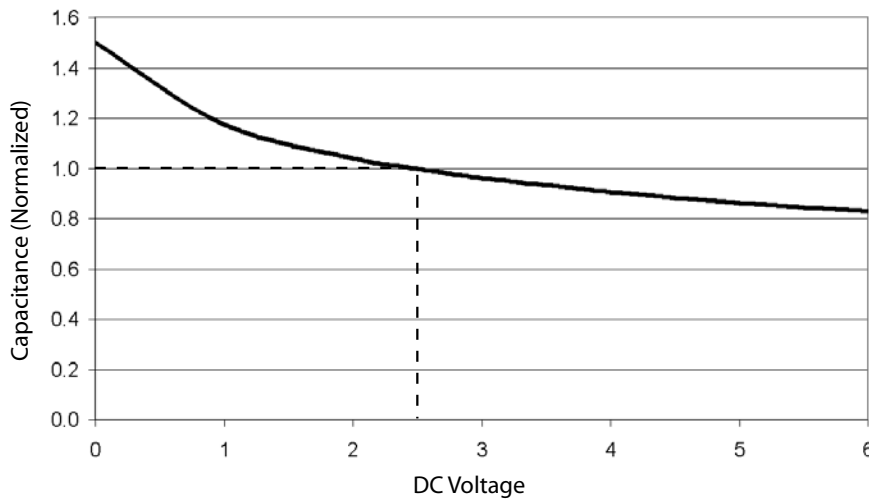

Figure 2. Filter Capacitance vs. Input Voltage (normalized to capacitance at 2.5VDC and 25°C)

Mechanical Details

TDFN-12 Mechanical Specifications

The CM1409-06DF/DE is supplied in an 12-lead, 0.5mm pitch TDFN package. Dimensions are presented below.

For complete information on the TDFN-12, see the California Micro Devices TDFN Package Information document.

PACKAGE DIMENSIONS						
Package	TDFN					
JEDEC No.	MO-229C [†]					
Leads	12					
Dim.	Millimeters			Inches		
	Min	Nom	Max	Min	Nom	Max
A	0.70	0.75	0.80	0.028	0.030	0.031
A3	0.20 REF			0.008 REF		
b	0.20	0.25	0.30	0.008	0.010	0.012
D	2.90	3.00	3.10	0.114	0.118	0.122
D2	2.40	2.50	2.60	0.095	0.098	0.102
E	1.25	1.35	1.45	0.049	0.053	0.057
E2	0.35	0.40	0.45	0.014	0.016	0.018
e	0.50 BSC			0.020 BSC		
K	0.20			0.008		
L	0.20	0.25	0.30	0.008	0.010	0.012
# per tape and reel	3000 pieces					
Controlling dimension: millimeters						

[†]This package is compliant with JEDEC standard MO-229C with the exception of the "D", "D2", "E", "E2", "K" and "L" dimensions as called out in the table above.

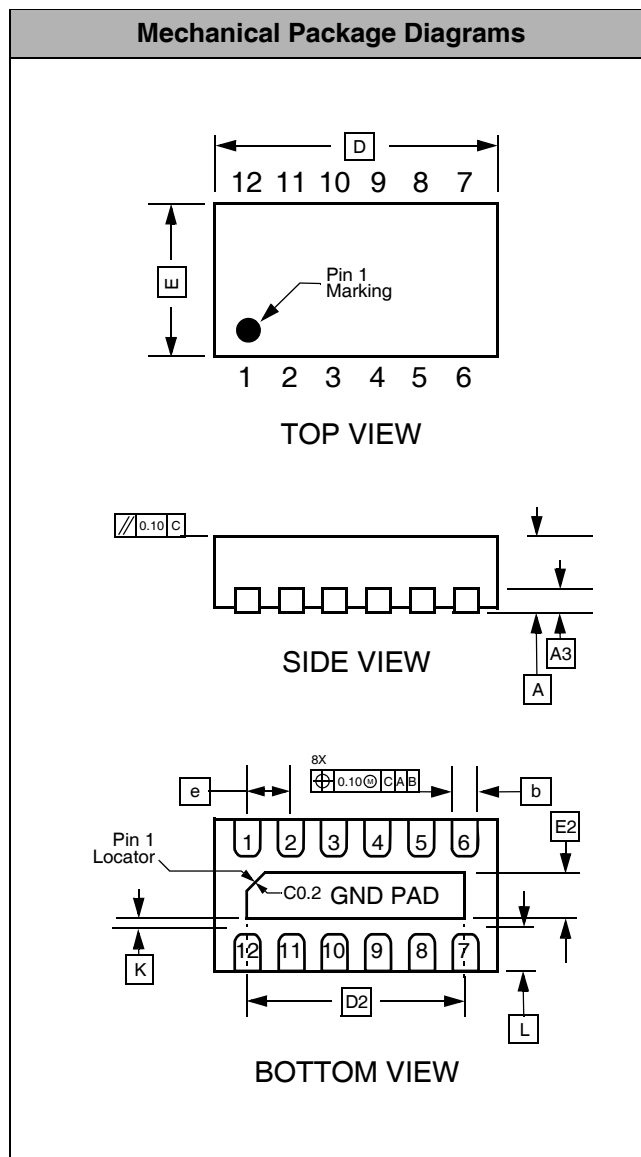

Dimensions for 12-Lead, 0.5mm pitch TDFN package

Mechanical Details (cont'd)

TDFN-12 Mechanical Specifications

The CM1409-E6DE is supplied in an 12-lead, 0.5mm pitch TDFN package. Dimensions are presented below.

For complete information on the TDFN-12, see the California Micro Devices TDFN Package Information document.

PACKAGE DIMENSIONS						
Package	TDFN					
JEDEC No.	MO-229C [†]					
Leads	12					
Dim.	Millimeters			Inches		
	Min	Nom	Max	Min	Nom	Max
A	0.70	0.75	0.80	0.028	0.030	0.031
A3	0.20 REF			0.008 REF		
b	0.20	0.25	0.30	0.008	0.010	0.012
D	2.90	3.00	3.10	0.114	0.118	0.122
D2	2.10	2.20	2.30	0.083	0.087	0.091
E	1.25	1.35	1.45	0.049	0.053	0.057
E2	0.25	0.30	0.35	0.008	0.012	0.014
e	0.50 BSC			0.020 BSC		
K	0.20			0.008		
L	0.20	0.25	0.30	0.008	0.010	0.012
M	0.20 REF			0.008 REF		
N	0.25 REF			0.010 REF		
# per tape and reel	3000 pieces					
Controlling dimension: millimeters						

[†]This package is compliant with JEDEC standard MO-229C with the exception of the "D", "D2", "E", "E2", "K" and "L" dimensions as called out in the table above.

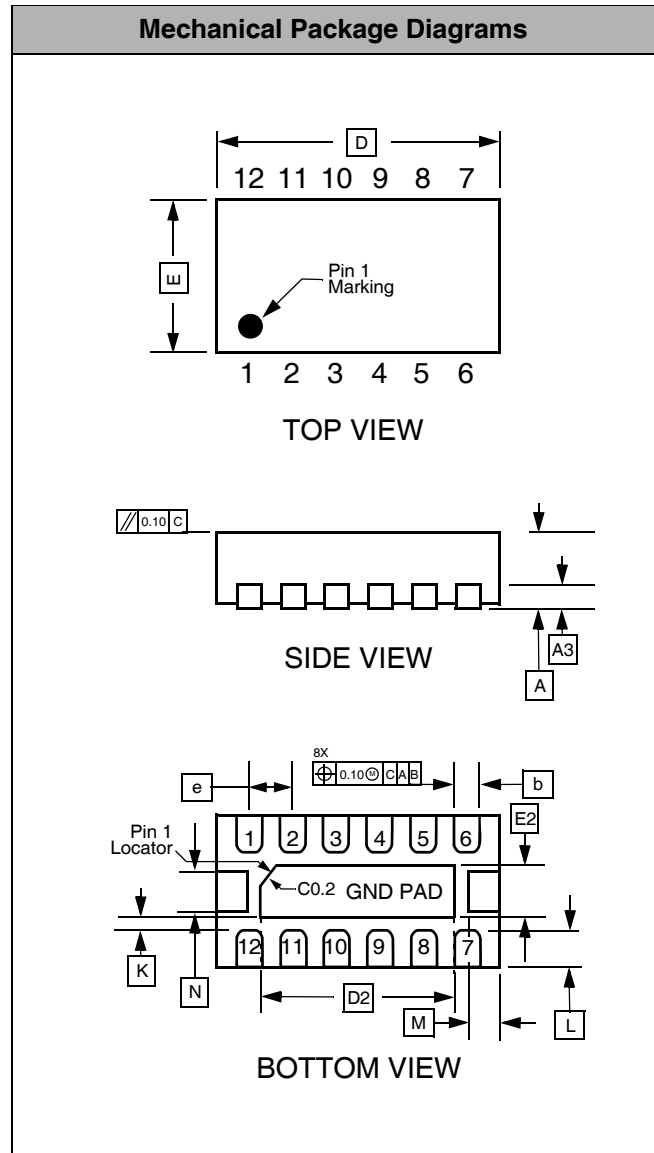

Dimensions for 12-Lead, 0.5mm pitch TDFN package

Mechanical Details (cont'd)

TDFN-16 Mechanical Specifications

The CM1409-08DE/DF is supplied in an 16-lead, 0.5mm pitch TDFN package. Dimensions are presented below.

For complete information on the TDFN-16, see the California Micro Devices TDFN Package Information document.

PACKAGE DIMENSIONS						
Package	TDFN					
JEDEC No.	MO-229C [†]					
Leads	16					
Dim.	Millimeters			Inches		
	Min	Nom	Max	Min	Nom	Max
A	0.70	0.75	0.80	0.028	0.030	0.031
A3	0.20 REF			0.008 REF		
b	0.20	0.25	0.30	0.008	0.010	0.012
D	3.90	4.00	4.10	0.153	0.157	0.161
D2	3.10	3.20	3.30	0.122	0.126	0.130
E	1.50	1.60	1.70	0.059	0.063	0.067
E2	0.30	0.40	0.50	0.012	0.016	0.020
e	0.50 BSC			0.020 BSC		
K	0.20			0.008		
L	0.20	0.30	0.40	0.008	0.010	0.012
M	0.25 REF			0.010 REF		
# per tape and reel	3000 pieces					
Controlling dimension: millimeters						

[†]This package is compliant with JEDEC standard MO-229C with the exception of the "D", "D2", "E", "E2", "K" and "L" dimensions as called out in the table above.

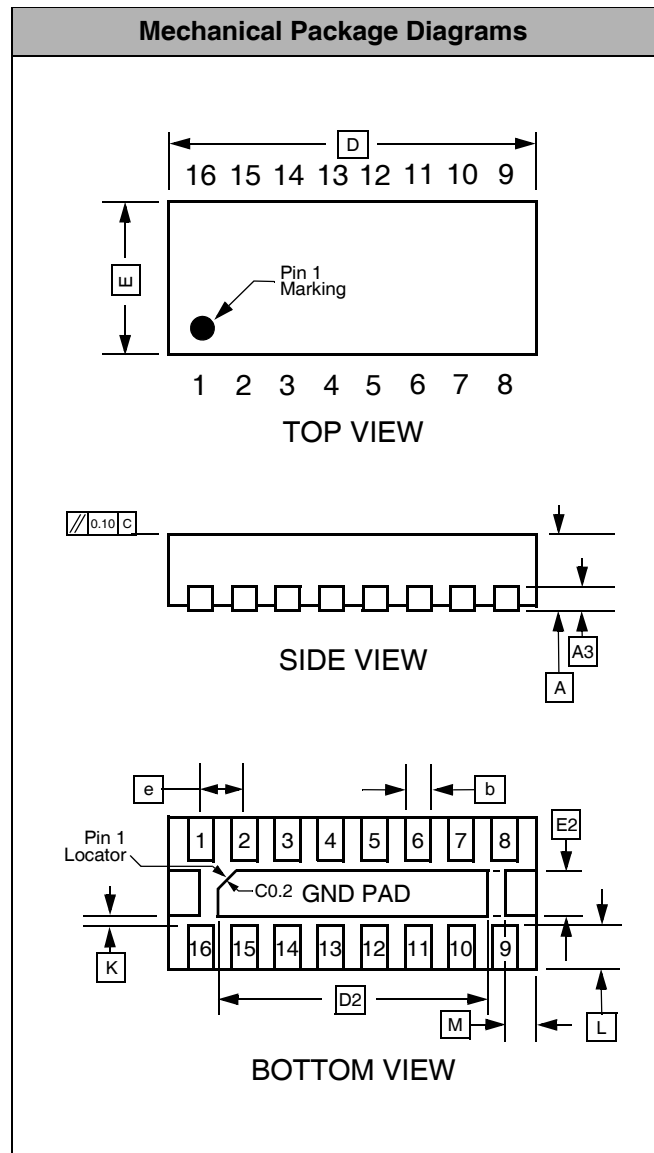

Dimensions for 16-Lead, 0.5mm pitch TDFN package

Cirek POD-CEC-DFN16-013 4.00x1.60mm, 0.5mm pitch 16L TDFN