

Micropower 500mA Low Voltage CMOS Regulator

Features

- Regulated 1.3 volt output
- Guaranteed 500mA output current
- Operates from 3.3V supply
- Low quiescent operating current (< 500µA typical)
- Current limit protection
- Thermal overload protection
- Reverse voltage protection
- Thermally-enhanced MSOP-8 package

Product Description

The CM3001 Micropower CMOS Regulator delivers up to 500mA of load current at a fixed voltage output of 1.3 volts. Operating from a single input supply, this device is ideally suited for powering low voltage “core” processors, especially where a 3.3V source is already available.

The CM3001 is fully protected, offering both overload current limiting and high temperature thermal shut-down. Housed in a space-saving thermally-enhanced MSOP-8 package, this device ensures maximum junction-to-ambient power dissipation.

Applications

- Low Voltage "Core" Processors
- Peripheral Adapter Cards
- Portable/Battery-Powered Devices

Typical Application Circuit

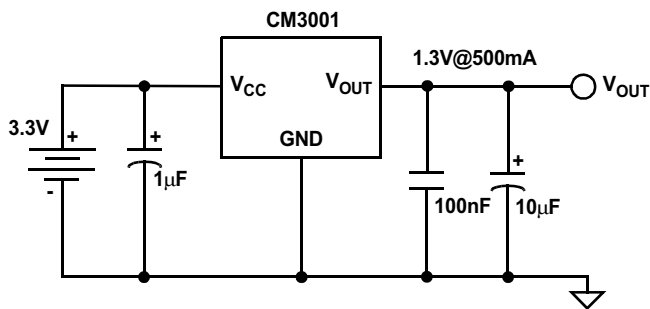

Simplified Electrical Schematic

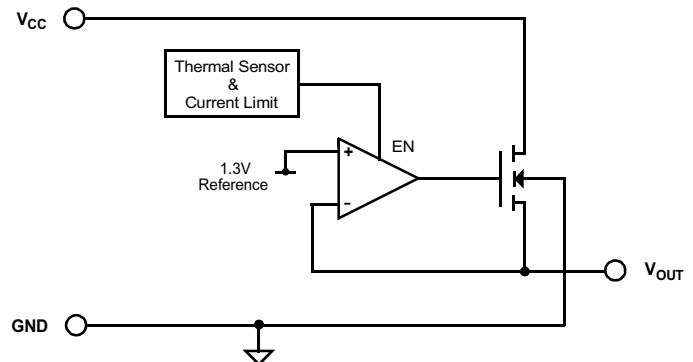

Specifications

ABSOLUTE MAXIMUM RATINGS

PARAMETER	RATING	UNITS
ESD Protection (HBM)	±2000	V
Pin Voltages		
V _{CC}	[GND - 0.4] to [+6.0]	V
V _{OUT}	[GND - 0.4] to [+6.0]	V
Storage Temperature Range	-40 to +150	°C
Operating Temperature Range		
Ambient	0 to +70	°C
Junction	0 to +150	°C
Power Dissipation (Note 1)	Internally Limited	W

Note 1: The MSOP package used is thermally enhanced through the use of a fused integral leadframe. The power rating is based on a printed circuit board heat spreading capability equivalent to 2 square inches of copper connected to the GND pins. Typical multi-layer boards using power plane construction will provide this heat spreading ability without the need for additional dedicated copper area. Please consult with factory for thermal evaluation assistance.

STANDARD OPERATING CONDITIONS

PARAMETER	RATING	UNITS
V _{CC}	3.0 to 3.6	V
Ambient Operating Temperature Range	0 to +70	°C
Load Current	0 to 500	mA
C _{EXT}	10 ±20%	µF

ELECTRICAL OPERATING CHARACTERISTICS

SYMBOL	PARAMETER	CONDITIONS	MIN	TYP	MAX	UNITS
V _{OUT}	Regulator Output Voltage	0mA < I _{LOAD} < 500mA	1.23	1.30	1.37	V
I _{LIM}	Overload Current Limit			800		mA
V _{R LOAD}	Load Regulation	10mA < I _{LOAD} < 500mA; V _{CC} =3.3V		20		mV
V _{R LINE}	Line Regulation	I _{LOAD} = 5mA; 3.0V ≤ V _{CC} ≤ 5.5V		20		mV
I _Q	Quiescent Current	I _{LOAD} = 0mA		500	900	µA
I _{GND}	Ground Current	I _{LOAD} = 0mA I _{LOAD} = 1000mA		500 500	900 900	µA µA
I _{RCC}	V _{CC} Pin Reverse Leakage	V _{OUT} = 3.3V; V _{CC} = 0V		1	100	µA
T _{DISABLE}	Shutdown Temperature			160		°C
T _{HYST}	Thermal Hysteresis			25		°C



Performance Information

CM3001 Typical DC Characteristics (nominal conditions unless specified otherwise)

Line Regulation with 500mA Load

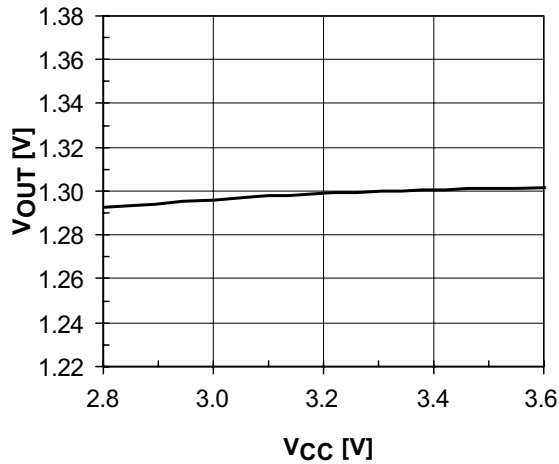

Load Regulation

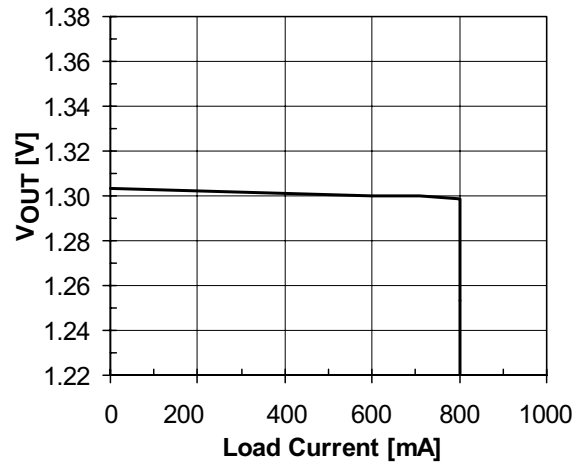

Supply Current vs. Voltage

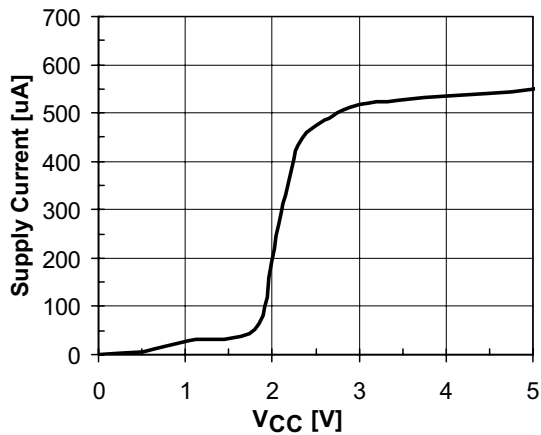

Ground Current vs. Output Load

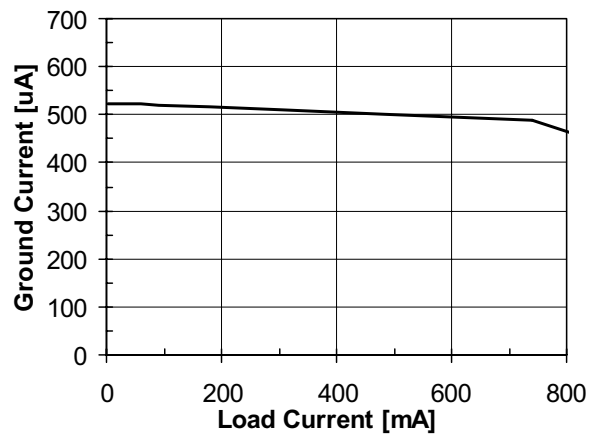

Performance Information (cont'd)

CM3001 Typical Transient Characteristics (nominal conditions unless specified otherwise)

Cold Start Power-up with Rated Load

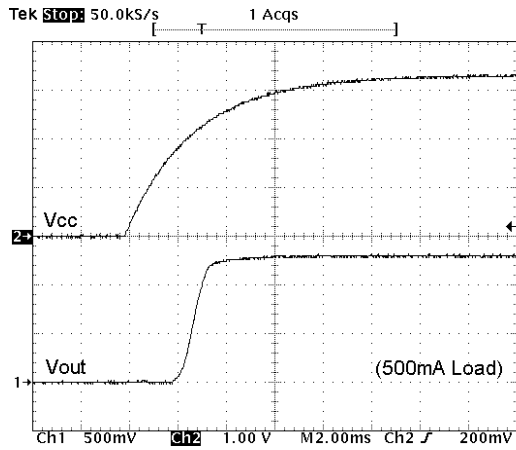

Full Power Down with Rated Load

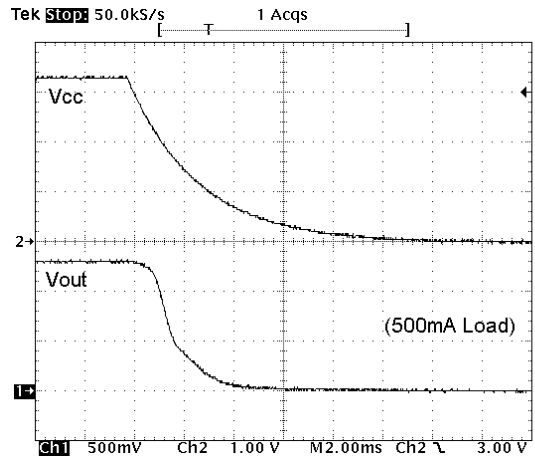

Load Transient Response (50mA to 500mA)

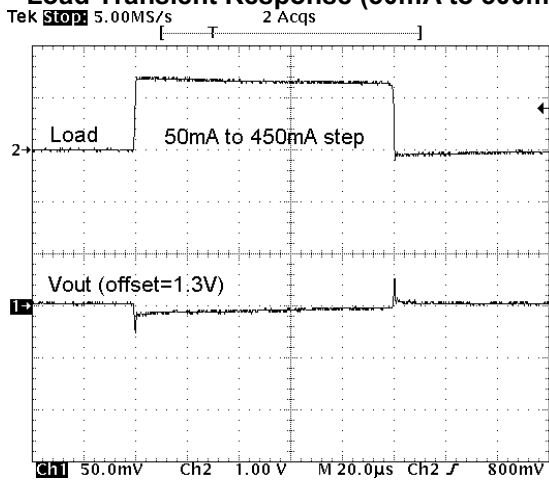

Line Transient Step Response (0.6Vp-p)

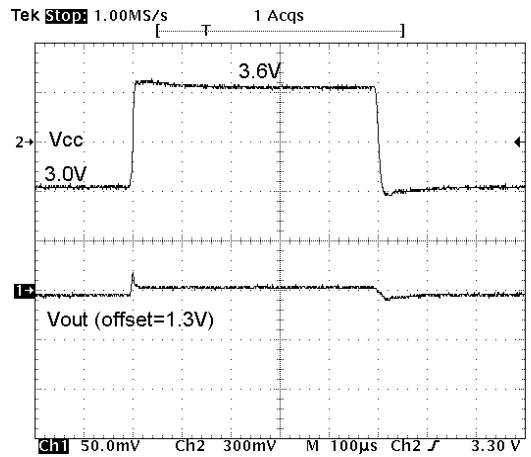

Performance Information (cont'd)

Typical Thermal Characteristics

The overall junction to ambient thermal resistance (θ_{JA}) for device power dissipation (P_D) consists primarily of two paths in series. The first path is the junction to the case (θ_{JC}) which is defined by the package style, and the second path is case to ambient (θ_{CA}) thermal resistance which is dependent on board layout. The final operating junction temperature for any set of conditions can be estimated by the following thermal equation:

$$\begin{aligned} T_{JUNC} &= T_{AMB} + P_D * (\theta_{JC}) + P_D * (\theta_{CA}) \\ &= T_{AMB} + P_D * (\theta_{JA}) \end{aligned}$$

The CM3001 uses a thermally enhanced MSOP package in which the GND pins (5 through 8) are integral to the leadframe. When this package is mounted on a double sided printed circuit board with two square inches of copper allocated for "heat spreading", the resulting θ_{JA} is about 70°C/W.

Based on a power dissipation of .8W (Load x Vin-Vout = .4A x [3.3V-1.3V]) with an ambient of 70°C, the resulting junction temperature will be:

$$\begin{aligned} T_{JUNC} &= T_{AMB} + P_D * (\theta_{JA}) \\ &= 70^\circ\text{C} + .8\text{W} * (70^\circ\text{C/W}) \\ &= 70^\circ\text{C} + 55^\circ\text{C} = 125^\circ\text{C} \end{aligned}$$

Thermal characteristics were measured using a double sided board with two square inches of copper area connected to the GND pins for "heat spreading".

Measurements showing performance up to a junction temperature of 125°C are presented in Figure 1. They were performed under light load conditions (5mA); this allows the ambient temperature to be representative of the internal junction temperature.

Note: The use of multi-layer board construction with separate ground and power planes will further enhance the overall thermal performance. In the event of no copper area being dedicated for heat spreading, a multi-layer board construction using only the minimum size pad layout will typically provide the CM3001 with an overall θ_{JA} of 70°C/W, which allows up to 0.8W to be dissipated safely.

Please consult CAMD Technical Support for assistance with thermal analysis of the CM3001 with respect to a specific application.

Output Voltage with temperature (5mA Load)

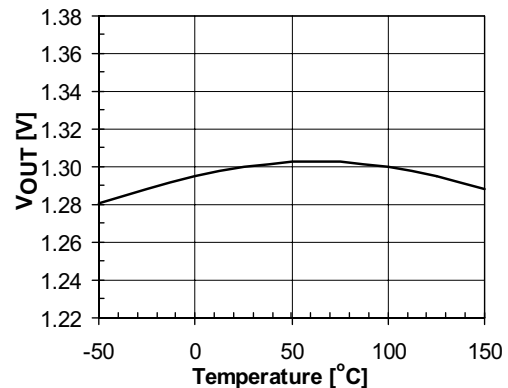

Output Voltage with temperature (500mA Load)

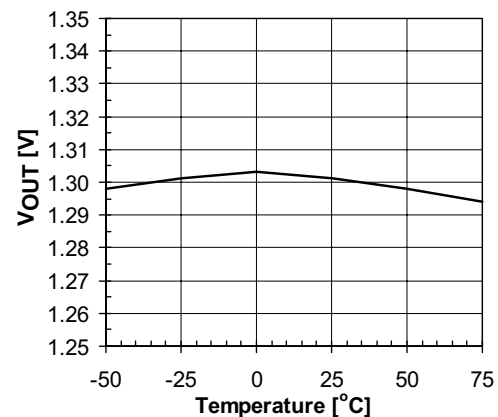

Ground Current with Temperature (No Load)

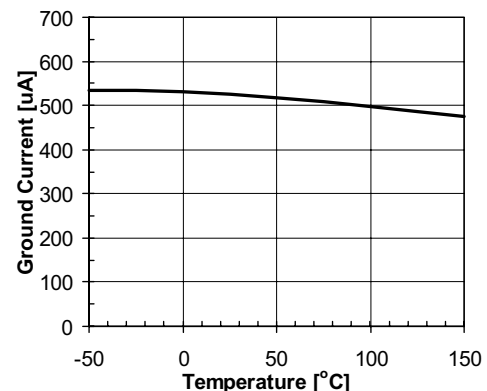

**Figure 1. CM3001
Performance vs. Temperature**

Mechanical Details

MSOP-8 Mechanical Specifications:

CM3001-13MA device is packaged in 8-pin MSOP package. Dimensions are presented below.

For complete information on the MSOP-8 package, see the California Micro Devices MSOP Package Information document.

PACKAGE DIMENSIONS				
Package	MSOP			
Pins	8			
Dimensions	Millimeters		Inches	
	Min	Max	Min	Max
A	0.87	1.17	0.034	0.046
A1	0.05	0.25	0.002	0.010
B	0.30 (typ)		0.012 (typ)	
C	0.18		0.007	
D	2.90	3.10	0.114	0.122
E	2.90	3.10	0.114	0.122
e	0.65 BSC		0.025 BSC	
H	4.78	4.98	0.188	0.196
L	0.52	0.54	0.017	0.025
# per tube	80 pieces*			
# per tape and reel	4000 pieces			
Controlling dimension: inches				

* This is an approximate number which may vary.

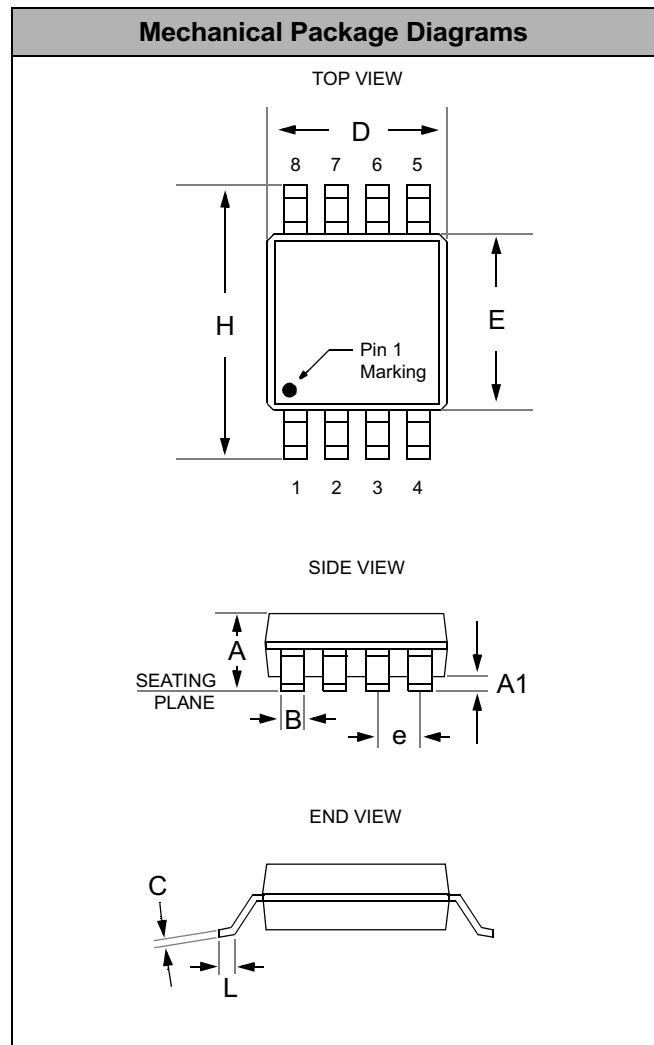

Package Dimensions for MSOP-8