

Micropower, 150mA Low Dropout CMOS Regulator

Features

- Various regulated output voltages
- Ultra low noise (35 μ V typ.)
- Delivers up to 150mA output current
- Very low dropout (150mV at 150mA)
- Low quiescent operating current (70 μ A)
- "Zero" disable mode current consumption
- Thermal overload protection
- Foldback overload current protection
- -40°C to +85°C temperature operation
- Tiny SOT23 package

Applications

- Cell/mobile phones, PDAs, MP3 players, digital cameras, camcorders
- CompactFlash memory cards
- Lithium ion battery-powered devices
- PC Cards

CM3014 Regulator Family

PRODUCT	OUTPUT VOLTAGE
CM3014-15ST	1.5V
CM3014-18ST	1.8V
CM3014-25ST	2.5V
CM3014-28ST	2.8V
CM3014-29ST	2.9V
CM3014-30ST	3.0V
CM3014-33ST	3.3V

Product Description

The CM3014 is a very low dropout, low noise regulator that delivers up to 150mA of load current at a fixed output voltage.

A dedicated control input (EN, Active High) provides power-up sequencing flexibility. When this input is taken low, the regulator is disabled. In this state, the supply current will drop to near zero. An internal discharge MOSFET resistance (300 Ω) will force the output to ground whenever the device is disabled.

An optional bypass pin is provided for further improvement of noise performance and to maximize the power supply ripple rejection.

The CM3014 is fully protected, offering both overload current limiting and high temperature thermal shut-down.

Available in a tiny 5 lead SOT-23 package, the device is ideal for space critical applications.

Typical Application Circuit

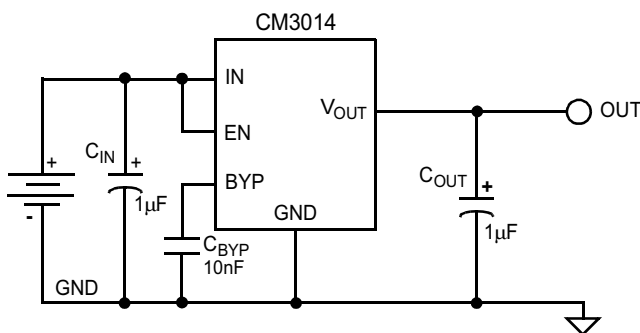

Simplified Electrical Schematic

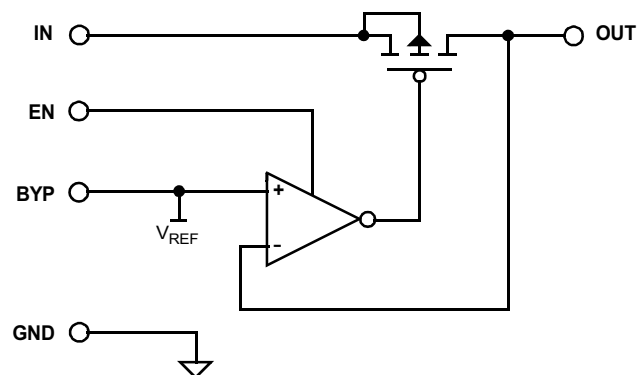

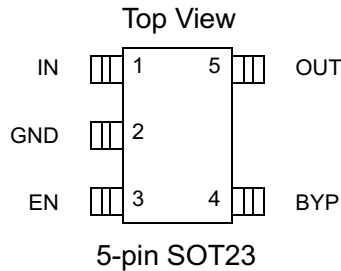
PACKAGE / PINOUT DIAGRAM

Note: This drawing is not to scale.

PIN DESCRIPTIONS

PIN(S)	NAME	DESCRIPTION
1	IN	The input power supply for the regulator. If this input is within a few inches of the main supply filter, a capacitor may not be necessary. Otherwise an input filter capacitor of approximately 1uF will ensure adequate filtering.
2	GND	The negative reference for all voltages.
3	EN	A logic input control to enable the regulator output. When EN is asserted (logic high), it allows output regulation to commence. When EN is deasserted (logic low), the regulator pass transistor is forced into a high impedance mode, and an internal discharge resistance (300Ω) is applied to the output.
4	BYP	This pin is connected to the internal voltage reference of the regulator. An external bypass capacitor C _{BYP} of 10nF is recommended to improve the noise performance and to maximize the power supply ripple rejection.
5	OUT	The regulator voltage output used to power the load.

Ordering Information
PART NUMBERING INFORMATION

Pins	Package	Ordering Part Number ¹	Part Marking
5	SOT23-5	CM3014-15ST	AC15
5	SOT23-5	CM3014-18ST	AC18
5	SOT23-5	CM3014-25ST	AC25
5	SOT23-5	CM3014-28ST	AC28
5	SOT23-5	CM3014-29ST	AC29
5	SOT23-5	CM3014-30ST	AC30
5	SOT23-5	CM3014-33ST	AC33

Note 1: Parts are shipped in Tape & Reel form unless otherwise specified.



Specifications

ABSOLUTE MAXIMUM RATINGS		
PARAMETER	RATING	UNITS
ESD Protection (HBM)	±2000	V
Pin Voltages		
IN (pin 1)	[GND - 0.6] to [+6.0]	V
EN (pin 3)	[GND - 0.6] to [V _{IN} + 0.6]	V
OUT (pin 5)	[GND - 0.6] to [V _{IN} + 0.6]	V
Storage Temperature Range	-40 to +150	°C
Operating Temperature Range		
Ambient	-40 to +85	°C
Junction	-40 to +125	°C
Power Dissipation (Notes 1,2)	Internally Limited	W

Note 1: The CM3014 contains a thermal overload circuit that automatically disables the device thereby preventing excessive junction temperature. When the SOT23-5 package housing the device is mounted on a typical multi-layer board with moderate heat spreading copper area (2 square inches) will allow up to 0.315W to be safely dissipated. (Please consult with factory for thermal evaluation assistance)

Note 2: Consult CAMD Technical Support for power dissipation information regarding the CM3014 packaged in the SOT23 package.

STANDARD OPERATING CONDITIONS		
PARAMETER	RATING	UNITS
V _{IN}	2.7 to 5.5	V
Ambient Operating Temperature Range	-40 to +85	°C
Load Current	0 to +150	mA
C _{OUT} (Note 3)	Output Voltage Dependent	µF

Note 3: See Application Information section for a recommendation on the output capacitor.

Specifications (continued)

ELECTRICAL OPERATING CHARACTERISTICS¹						
SYMBOL	PARAMETER	CONDITIONS	MIN	TYP	MAX	UNITS
V _{OUT}	Regulator Output Voltage	0mA < I _{LOAD} < 150mA; See Note 2	-5%		+5%	V
R _{DROPOUT}	Dropout Resistance	0mA < I _{LOAD} < 150mA; T _A =25°C		1	1.3	Ω
V _{R LOAD}	Load Regulation	V _{IN} -V _{OUT} =1V; 10mA < I _{LOAD} < 150mA		5		mV
V _{R LINE}	Line Regulation	I _{LOAD} = 5mA		20		mV/V
I _{LIM}	Overload Current Limit			400		mA
I _{SC}	Short Circuit Current Limit	V _{OUT} < 1V		200		mA
R _{DISCH}	Discharge Resistance	EN tied to ground; V _{IN} =3.0V		300		Ω
I _{GND}	Ground Current	with EN tied to V _{IN} ; I _{LOAD} =0mA: with EN tied to V _{IN} ; I _{LOAD} =150mA: with EN tied to GND (Disable Mode):		70 80 0.1	200 250 10	μA μA μA
V _{IH}	Enable High Threshold	Regulator becomes enabled		0.8	1.2	V
V _{IL}	Enable Low Threshold	Regulator enters shutdown	0.4	0.7		V
T _{DISABLE}	Shutdown Temperature			150		°C
T _{HYST}	Thermal Hysteresis			20		°C
R _{REJ}	Ripple Rejection	f=120Hz; V _{IN} - V _{OUT} = 1V; I _{LOAD} = 100μA; C _{OUT} = 1μF Ceramic; C _{BYP} = 10nF		60		dB
E _{NOISE}	Output Noise	300Hz-100kHz; C _{OUT} = 1μF Ceramic; C _{BYP} = 10nF		35		μVrms

Note 1: Electrical operating characteristics are guaranteed over standard operating conditions unless otherwise noted.

Note 2: Regulator output voltage includes line regulation, load regulation and temperature over the indicated load current range.

Performance Information

Typical Noise Characteristics

Curves shown for 2.8V output

Power Supply Ripple Rejection

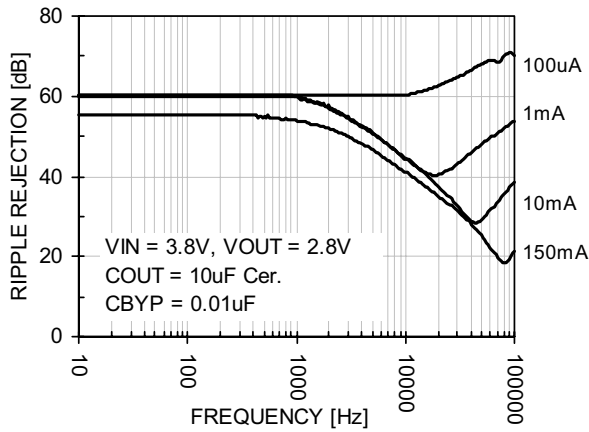

Power Supply Ripple Rejection

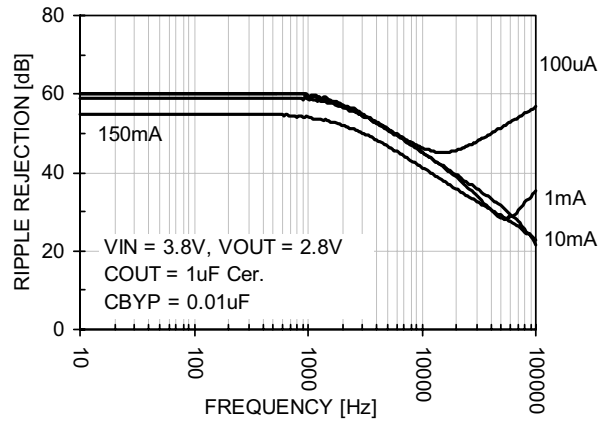

Power Supply Ripple Rejection

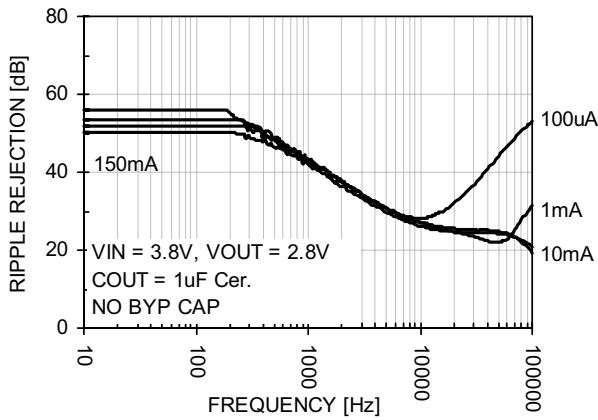

Power Supply Ripple Rejection Vs. Voltage Drop (1kHz)

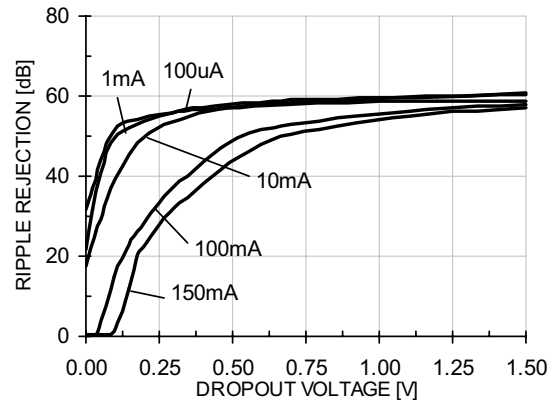

Noise Performance

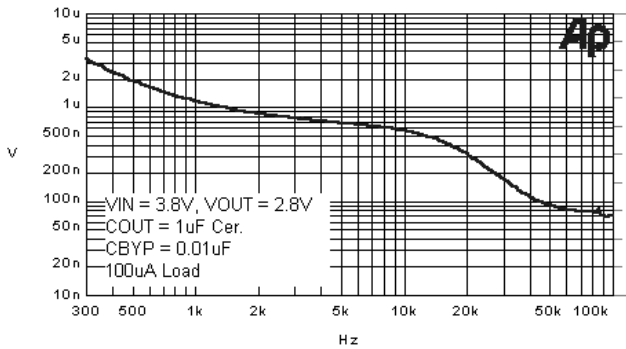

Noise Performance

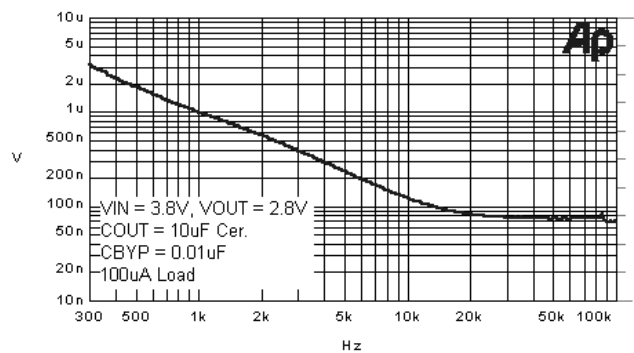



Performance Information (cont'd)

Typical DC Characteristics (nominal conditions unless otherwise specified)

Curves shown for 2.8V output.

Ground Current vs. Input (5mA Load)

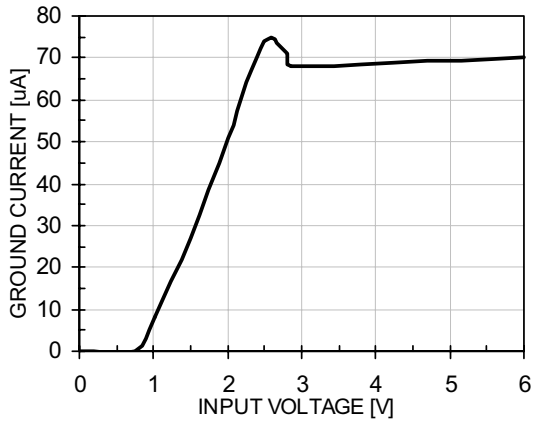

Ground Current vs. Load (VIN = 3.8V)

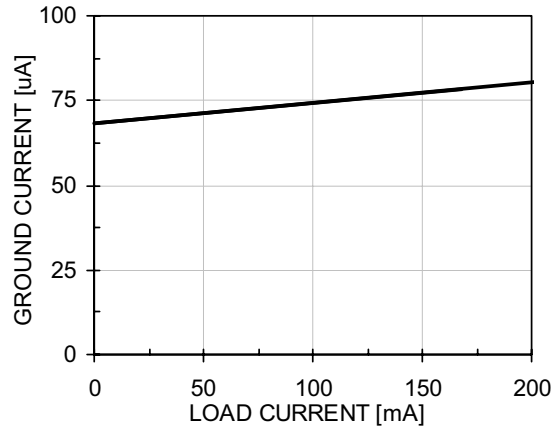

Load Regulation (VIN = 3.8V)

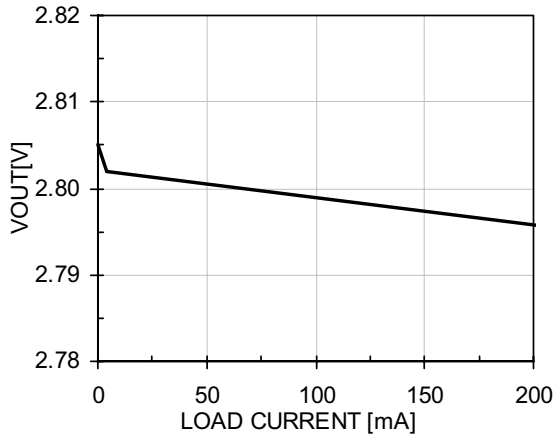

Dropout Voltage vs. Load Current (VOUT = 2.7V)

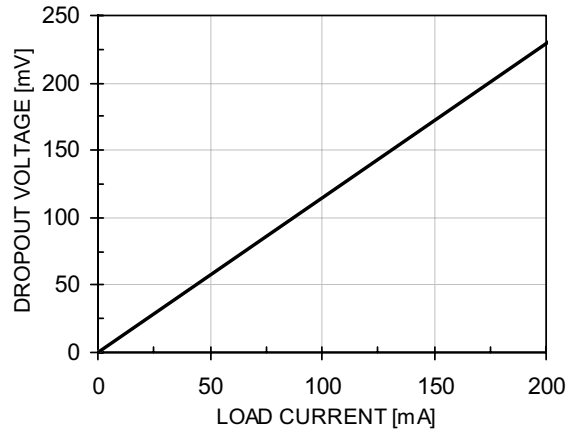

Line Regulation (5mA Load)

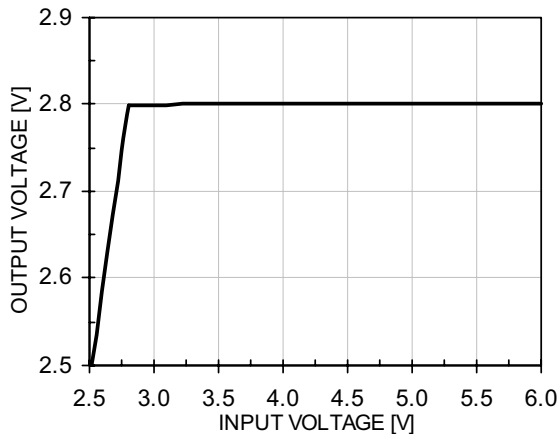

Foldback Current Limiting (VIN = 3.8V)

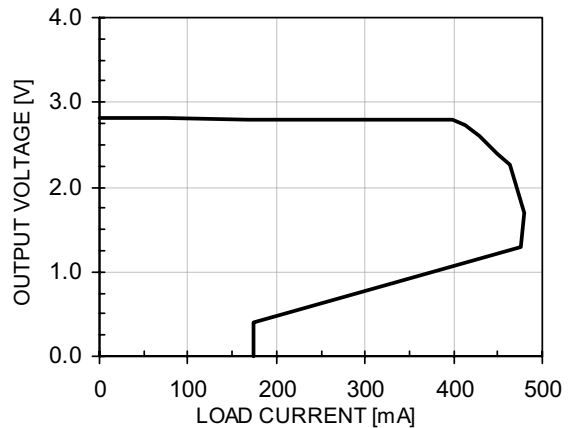

Performance Information (cont'd)

Typical Transient Characteristics (nominal conditions unless specified otherwise)

Curves shown for 2.8V output.

Load transient (10% to 100%) Step Response

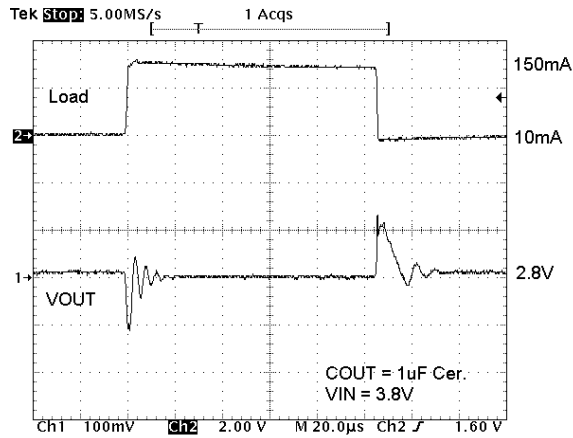

Line Transient (1Vpp) Step Response

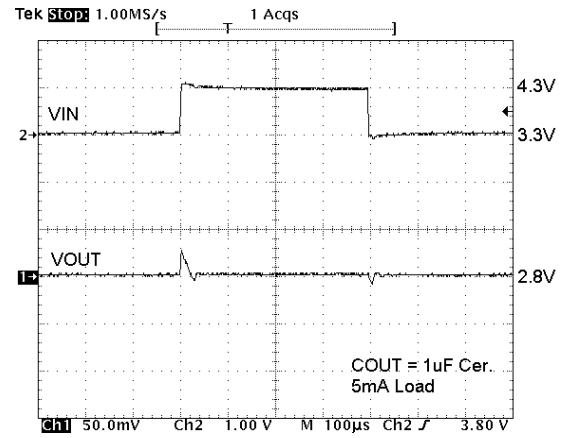

Enable Response (CBYP = 10nF)

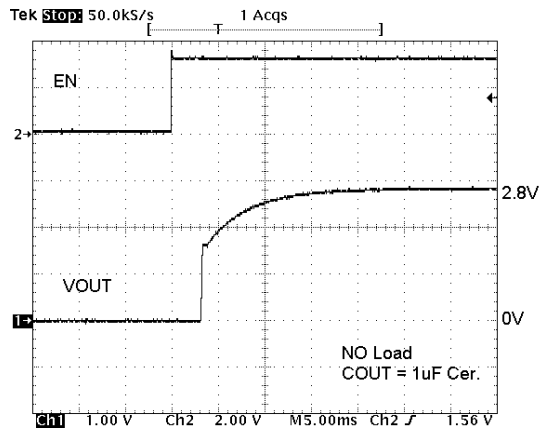

Disable Response (CBYP = 10nF)

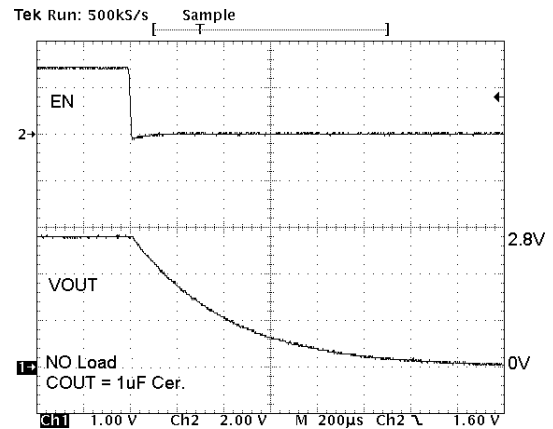

Performance Information (cont'd)

Typical Thermal Characteristics

The overall junction to ambient thermal resistance (θ_{JA}) for device power dissipation (P_D) consists primarily of two paths in series. The first path is the junction to the case (θ_{JC}) which is defined by the package style, and the second path is case to ambient (θ_{CA}) thermal resistance which is dependent on board layout. The final operating junction temperature for any set of conditions can be estimated by the following thermal equation:

$$T_{JUNC} = T_{AMB} + P_D * (\theta_{JC}) + P_D * (\theta_{CA})$$

$$= T_{AMB} + P_D * (\theta_{JA})$$

The CM3014 uses a SOT23-5 package. When this package is mounted on a double-sided printed circuit board with two square inches of copper allocated for "heat spreading", the resulting θ_{JA} is 175°C/W.

Based on a maximum power dissipation of 320mW (Load x Vin-Vout = 150mA x 2.2V) with an ambient of 70°C the resulting junction temperature will be:

$$T_{JUNC} = T_{AMB} + P_D * (\theta_{JA})$$

$$= 70^\circ\text{C} + 315\text{mW} * (175^\circ\text{C/W})$$

$$= 70^\circ\text{C} + 57.75^\circ\text{C} = 127.75^\circ\text{C}$$

Thermal characteristics were measured using a double sided board with two square inches of copper area connected to the GND pins for "heat spreading".

Measurements showing performance up to a junction temperature of 125°C were performed under light load conditions (1mA). This allows the ambient temperature to be representative of the internal junction temperature.

Note: The use of multi-layer board construction with separate ground and power planes will further enhance the overall thermal performance. In the event of no copper area being dedicated for heat spreading, a multi-layer board construction using only the minimum size pad layout will typically provide the CM3014 with an overall θ_{JA} of 175°C/W, which allows up to 450mW to be dissipated safely.

Please consult CAMD Technical Support for assistance with thermal analysis of the CM3014 with respect to a specific application.

Output Voltage Change vs. Temperature (1mA Load)

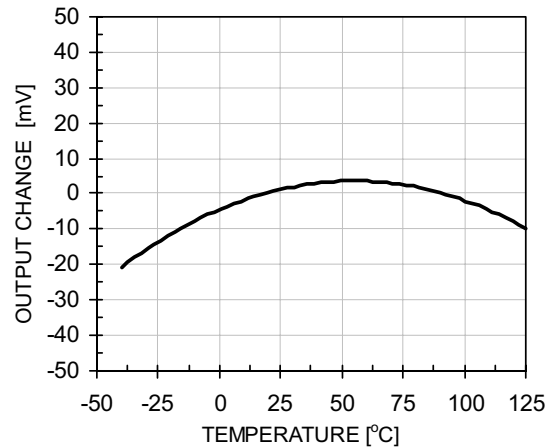

Ground Current vs. Temperature

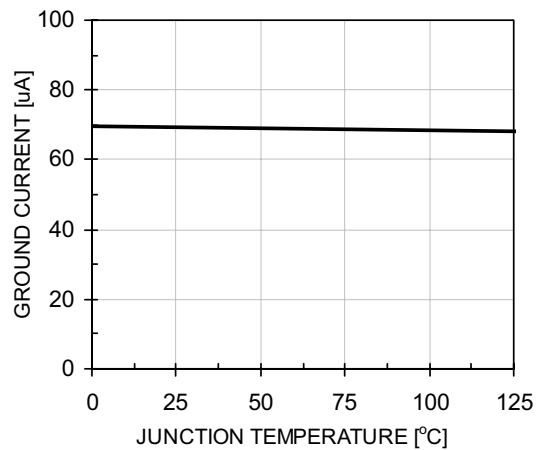

Figure 1. CM3014 Performance vs. Temperature

Application Information

Input Capacitor

If the regulator input is located more than several inches away from the supply source or filter capacitor, a 1 μ F ceramic capacitor is necessary at the input pin.

Output Capacitor

The CM3014 regulator requires a capacitor between the output pin and the ground for best performance during load transient. Tantalum capacitors of 1 μ F provide with good transient response for all output versions. Ceramic capacitors with their inherent low ESR (equivalent series resistor) are only applicable to the higher output voltage options which are 2.5V and above. Table 1 lists the minimum recommended capacitor values for the various CM3014 output versions. The capacitor size can be increased to further improve the load transient response.

CM3014 OUTPUT VOLTAGE	CERAMIC CAPACITOR MINIMUM VALUE	TANTALUM CAPACITOR MINIMUM VALUE
3.3V	1 μ F	1 μ F
3.0V	1 μ F	1 μ F
2.9V	1 μ F	1 μ F
2.8V	1 μ F	1 μ F
2.5V	3.3 μ F	1 μ F
1.8V	N.A.	1 μ F
1.5V	N.A.	1 μ F

Table 1: Recommended Capacitor Values

Figure 2 and Figure 3 below show two examples of load transient responses for a step load from 10mA to 150mA. In Figure 2, extended oscillation is seen on the output. The ringing goes away when using a tantalum capacitor instead. Figure 3 illustrates a stable response that can be further improved by using a larger ceramic capacitor.

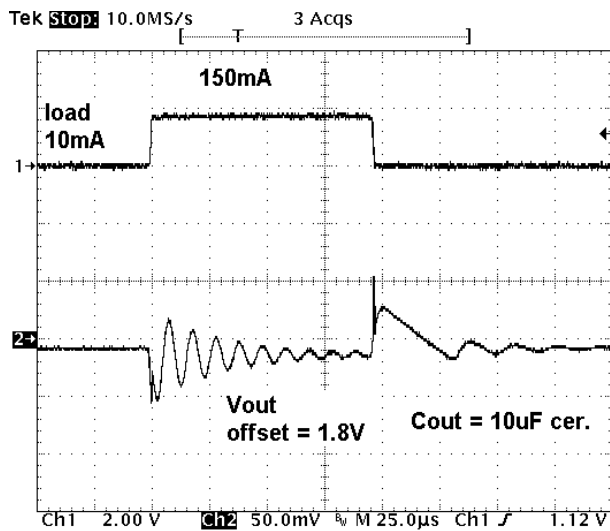

Figure 2. "Marginal" load transient response 1.8V output with 10 μ F ceramic capacitor

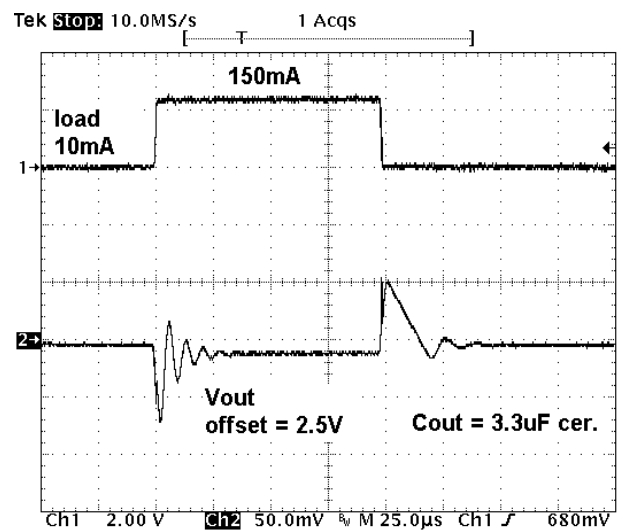

Figure 3. Stable Load Transient Response 2.5V output with 3.3 μ F ceramic capacitor

Mechanical Details

SOT23 Mechanical Specifications

Dimensions for CM3014 devices packaged in 5-pin SOT23 packages are presented below.

For complete information on the SOT23 package, see the California Micro Devices SOT23 Package Information document.

PACKAGE DIMENSIONS				
Package	SOT23 (JEDEC name is MO-178)			
Pins	5			
Dimensions	Millimeters		Inches	
	Min	Max	Min	Max
A	--	1.45	--	0.057
A1	0.00	0.15	0.000	0.006
b	0.30	0.50	0.012	0.020
c	0.08	0.22	0.003	0.009
D	2.75	3.05	0.108	0.120
E	2.60	3.00	0.102	0.118
E1	1.45	1.75	0.057	0.069
e	0.95 BSC		0.0374 BSC	
e1	1.90 BSC		0.0748 BSC	
L	0.60 REF		0.0236 REF	
# per tape and reel	3000 pieces			
Controlling dimension: inches				

