

## 400mA SmartOR™ Regulator with V<sub>AUX</sub> Switch

### Features

- Continuous 3.3V / 400mA output from two inputs
- Complete Power Management solution
- Built-in hysteresis when selecting input supplies
- Integrated switch featuring low RDS<sub>ON</sub> (0.25Ω typ.)
- Foldback current limiting protection
- Thermal overload shutdown protection
- 8-pin SOIC package
- Lead-free version available

### Applications

- PCI adapter cards with Wake-On-LAN
- Network Interface Cards (NICs)
- Multiple power supply systems
- Systems with standby capabilities

### Product Description

The CM3103 combines a fixed voltage regulator and a V<sub>AUX</sub> switch in a single 8-pin SOIC package. The voltage regulator is capable of delivering up to 400mA continuously at 3.3V. The output power is provided from two independent input voltage sources on a prioritized basis. Power is always taken in priority of V<sub>CC</sub>, then V<sub>AUX</sub>.

When V<sub>CC</sub> (5V) is present, the device automatically enables the regulator, producing a stable 3.3V output at V<sub>OUT</sub>, while disabling the V<sub>AUX</sub> switch.

When only V<sub>AUX</sub> (3.3V) is present, the device provides a low impedance direct connection (0.25Ω typ.) from V<sub>AUX</sub> to V<sub>OUT</sub>.

All the necessary control circuitry needed to provide a smooth and automatic transition between both supplies has been incorporated. This allows the V<sub>CC</sub> input supply to be dynamically switched without loss of output voltage.

The CM3103 is available with optional lead-free finishing.

### Typical Application Circuit

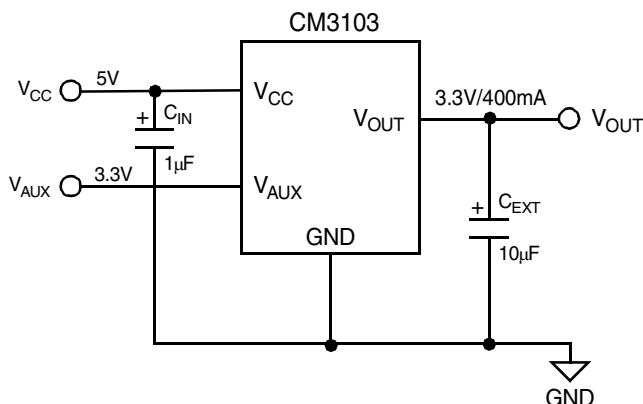

### Simplified Electrical Schematic

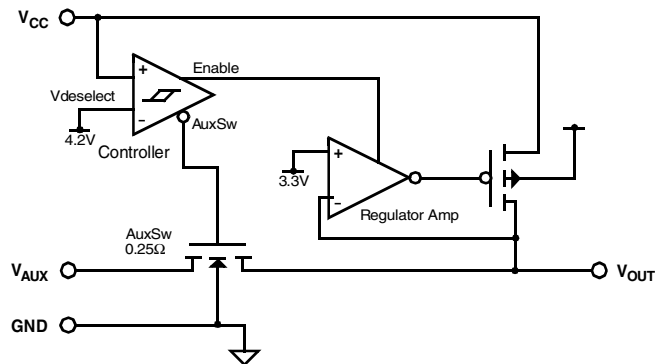



**PACKAGE / PINOUT DIAGRAM**

TOP VIEW

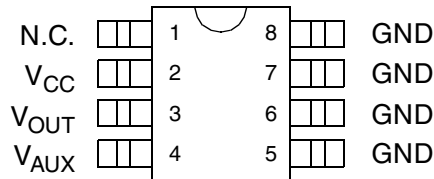

**8-pin Power SOIC**

Note: This drawing is not to scale.

**PIN DESCRIPTIONS**

PIN(S)	NAME	DESCRIPTION
1	N.C.	
2	V <sub>CC</sub>	Positive input supply for the voltage regulator. Whenever this supply voltage exceeds the V <sub>CCSEL</sub> level (4.4V), it will immediately be given priority and be used to power the regulator output. If this supply voltage falls below the V <sub>CCDES</sub> level (4.2V) it will immediately be deselected and no longer provide power for the regulator output. An internal hysteresis voltage of 0.2V is used to prevent any chatter during selection and deselection of V <sub>CC</sub> . The effective source impedance of V <sub>CC</sub> should be kept below 0.3 ohm to ensure changeover disturbances do not exceed the hysteresis level. If the connection to V <sub>CC</sub> is made within a few inches of the main input filter, a bypass capacitor may not be necessary. Otherwise a bypass filter capacitor in the range of 1μF to 10μF will ensure adequate filtering.
3	V <sub>OUT</sub>	Regulator output. Power is provided from the regulator or via the low impedance auxiliary switch. This output requires a capacitance of 10μF to ensure regulator stability and minimize the peak output disturbance during power supply changeover.
4	V <sub>AUX</sub>	Auxiliary voltage power source. This supply is selected only when V <sub>CC</sub> falls below 4.2V. Under these conditions an internal switch that provides a very low impedance connection directly between V <sub>OUT</sub> and V <sub>AUX</sub> is enabled .
5-8	GND	The negative reference for all voltages. Also functions as a thermal path for heat dissipation.

**Ordering Information**

**PART NUMBERING INFORMATION**

Pins	Package	Standard Finish		Lead-free Finish	
		Ordering Part Number <sup>1</sup>	Part Marking	Ordering Part Number <sup>1</sup>	Part Marking
8	Power SOIC	CM3103-01SA	CM3103SA	CM3103-01SF	CM3103SF

Note 1: Parts are shipped in Tape & Reel form unless otherwise specified.



## Specifications

ABSOLUTE MAXIMUM RATINGS		
PARAMETER	RATING	UNITS
ESD Protection (HBM)	±2000	V
Pin Input Voltages		
V <sub>CC</sub>	[GND - 0.5] to +6.0	V
V <sub>AUX</sub>	[GND - 0.5] to +4.0	V
Storage Temperature Range	-40 to +150	°C
Operating Temperature Range		
Ambient	0 to +70	°C
Junction	0 to +125	°C
Power Dissipation (See Note 1)	Internally Limited	W

Note 1: At rated load, the power dissipation will be 0.68Watt (1.7V x 0.4A). Under these conditions, (in a 70°C ambient), the thermal resistance from junction to ambient ( $\theta_{JA}$ ) must not exceed 80°C/W. This is typically achieved with 2 square inches of copper printed circuit board area connected to the GND pins for heat spreading, or equivalent.

STANDARD OPERATING CONDITIONS		
PARAMETER	VALUE	UNITS
V <sub>CC</sub>	5.0 ±0.25	V
V <sub>AUX</sub>	3.3 ±0.3	V
Ambient Operating Temperature Range	0 to +70	°C
Load Current	0 to 400	mA
C <sub>EXT</sub>	10 ±20%	µF



**ELECTRICAL OPERATING CHARACTERISTICS** (SEE NOTE 1)

SYMBOL	PARAMETER	CONDITIONS	MIN	TYP	MAX	UNITS
V <sub>OUT</sub>	Regulator Output Voltage	0mA < I <sub>LOAD</sub> < 400mA	3.135	3.300	3.465	V
I <sub>LIM</sub>	Regulator Current Limit	V <sub>OUT</sub> > 0V	410	500		mA
I <sub>SC</sub>	Short Circuit Current	V <sub>CC</sub> =5V, V <sub>OUT</sub> < 0V		150		mA
V <sub>R LOAD</sub>	Load Regulation	V <sub>CC</sub> =5V, 5mA ≤ I <sub>LOAD</sub> ≤ 400mA		20		mV
V <sub>R LINE</sub>	Line Regulation	I <sub>LOAD</sub> = 5mA; 4.5V ≤ V <sub>IN</sub> ≤ to 5.5V		2		mV
V <sub>CCSEL</sub>	V <sub>CC</sub> Select Voltage	V <sub>AUX</sub> present		4.40	4.60	V
V <sub>CCDES</sub>	V <sub>CC</sub> Deselect Voltage	V <sub>AUX</sub> present	4.00	4.20		V
V <sub>HYST</sub>	Hysteresis Voltage	V <sub>AUX</sub> present; See Note 2		0.20		V
R <sub>SW</sub>	V <sub>AUX</sub> Switch Resistance			0.25	0.40	Ω
I <sub>RCC</sub> I <sub>RAUX</sub>	V <sub>CC</sub> Reverse Leakage V <sub>AUX</sub> Reverse Leakage	One supply input taken to GND while the others remain at nominal voltage.		5	100	μA
I <sub>CC</sub>	V <sub>CC</sub> Supply Current	V <sub>CC</sub> > V <sub>CCSEL</sub> , I <sub>LOAD</sub> =0mA		0.8	1.5	mA
I <sub>AUX</sub>	V <sub>AUX</sub> Supply Current	V <sub>AUX</sub> is selected, I <sub>LOAD</sub> =0mA		0.20	0.30	mA
I <sub>GND</sub>	Ground Current	V <sub>AUX</sub> is selected, (V <sub>CC</sub> /S <sub>BY</sub> = 0V) V <sub>CC</sub> /S <sub>BY</sub> = 5V, I <sub>LOAD</sub> = 0mA V <sub>CC</sub> /S <sub>BY</sub> = 5V, I <sub>LOAD</sub> = 400mA		0.20 0.80 1.00	0.30 1.50 2.00	mA mA mA
T <sub>DISABLE</sub> T <sub>HYST</sub>	Shutdown Temperature Thermal Hysteresis			160 20		°C °C

Note 1: Operating characteristics are over Standard Operating Conditions unless otherwise specified.

Note 2: The disturbance on V<sub>CC</sub> during supply changeover should be kept below the hysteresis voltage to prevent any chatter. The source resistance on the V<sub>CC</sub> supply should be kept to less than 0.3 ohms to ensure precise switching.



### Performance Information

CM3103 Typical DC Characteristics (nominal conditions unless specified otherwise)

**V<sub>CC</sub> Supply Current vs. Voltage**

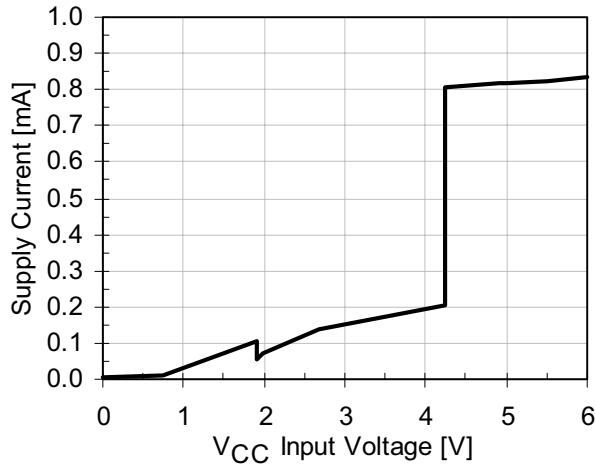

**V<sub>AUX</sub> Supply Current vs. Voltage**

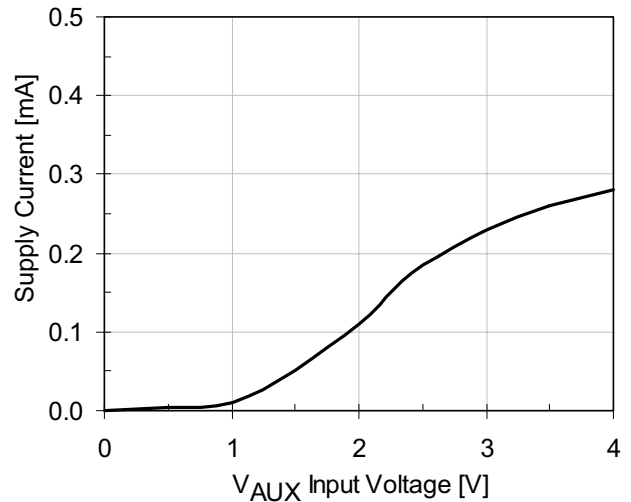

**Ground Current vs. Output Load**

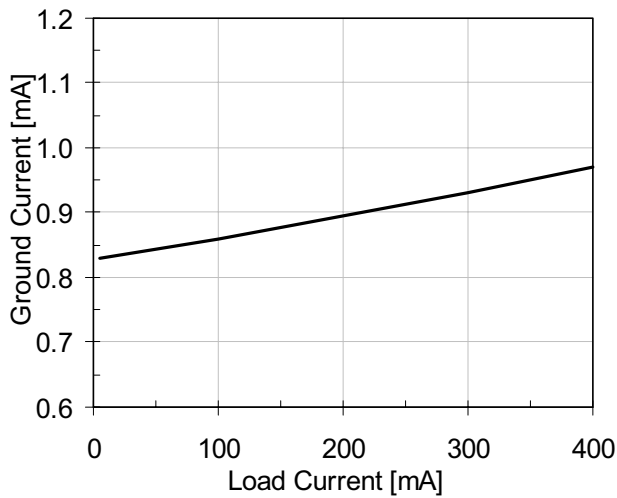

**Line Regulation**

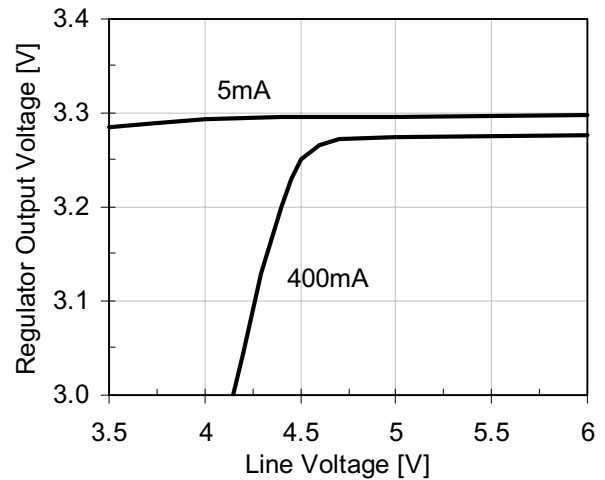



### Performance Information (cont'd)

CM3103 Typical DC Characteristics (cont'd, nominal conditions unless specified otherwise)

Load Regulation (5V supply)

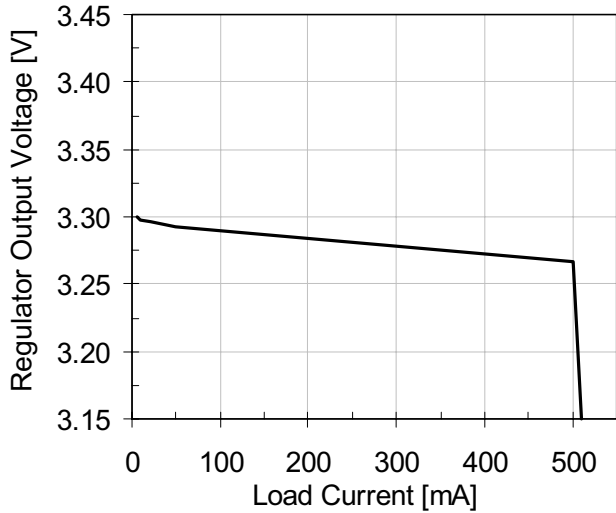

Foldback Current Limit Protection

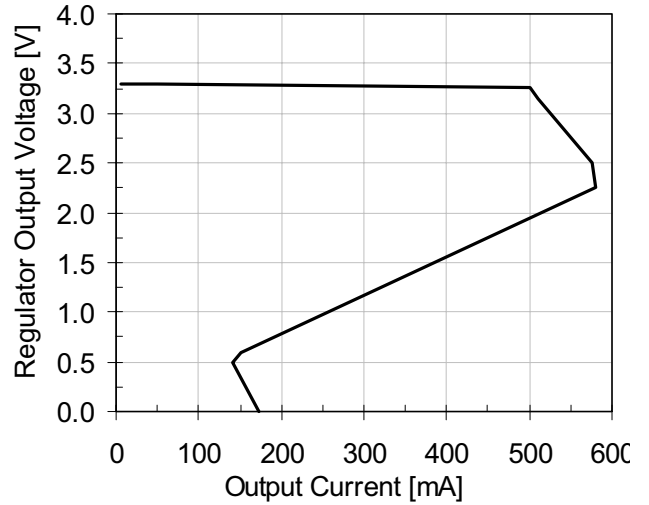

Regulator Dropout Characteristics

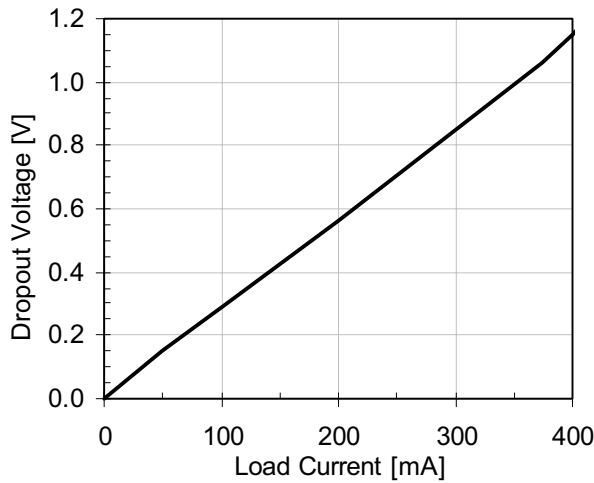

Switch Resistance vs.  $V_{AUX}$  supply

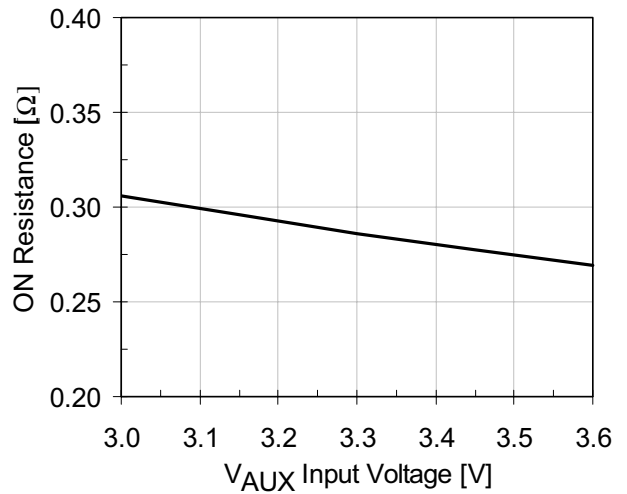



### Performance Information (cont'd)

CM3103 Transient Characteristics (nominal conditions unless specified otherwise)  
(V<sub>CC</sub> source resistance set to 0.2Ω)

V<sub>CC</sub> Cold Start (Load = 400mA)

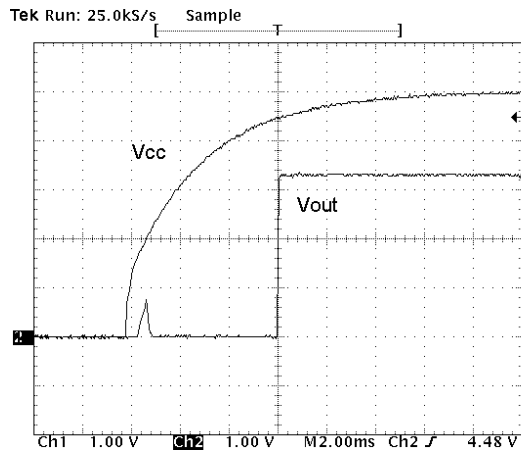

V<sub>CC</sub> Full Power Down (Load = 400mA)

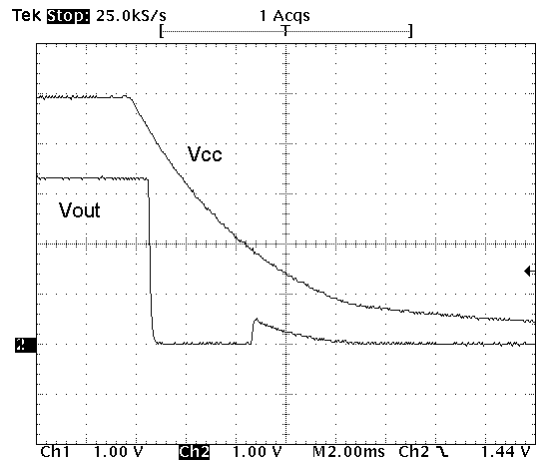

V<sub>AUX</sub> Cold Start (Load = 400mA)

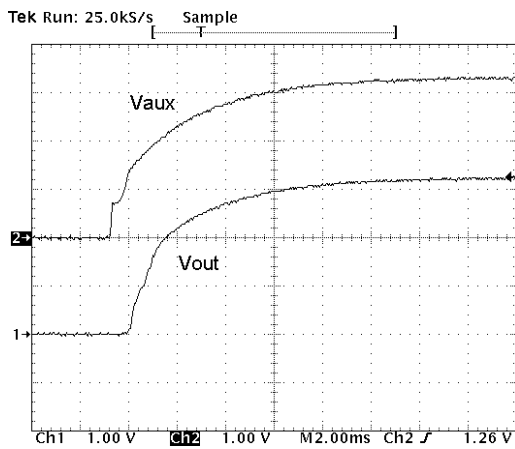

V<sub>AUX</sub> Full Power Down (Load = 400mA)

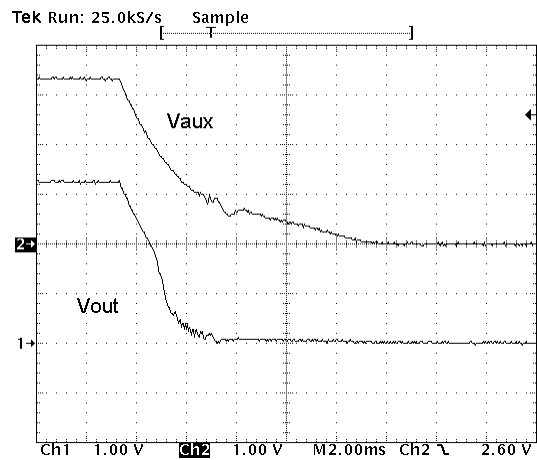



### Performance Information (cont'd)

CM3103 Transient Characteristics (cont'd; nominal conditions unless specified otherwise)  
(V<sub>CC</sub> source resistance set to 0.2Ω)

V<sub>CC</sub> power up (V<sub>AUX</sub> = 3.3V, Load = 300mA)

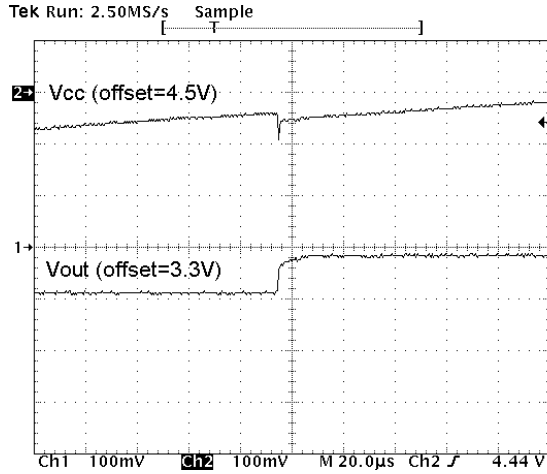

V<sub>CC</sub> power down (V<sub>AUX</sub> = 3.3V, Load = 300mA)

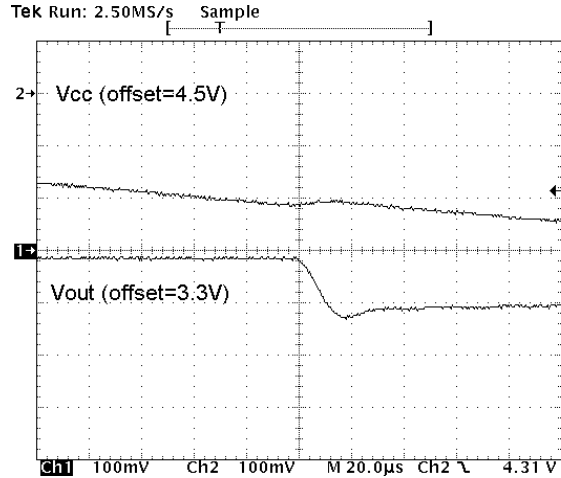

Load Transient Response (10% - 90% rated)

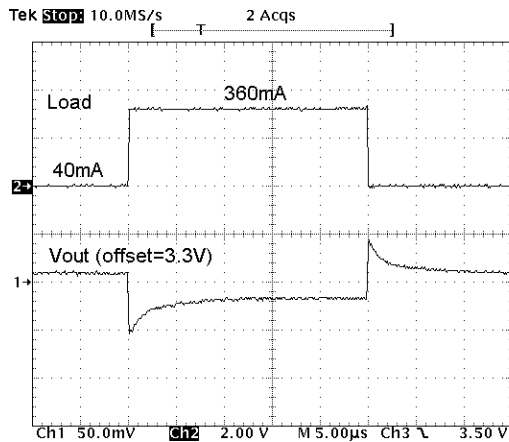

Line Transient (1Vpp) Response

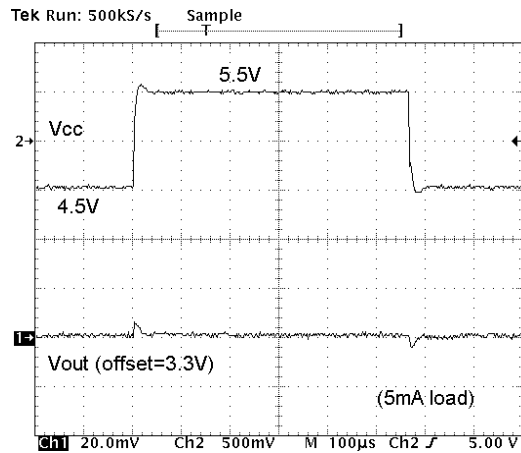





## Performance Information (cont'd)

### CM3103 Typical Thermal Characteristics

The overall junction to ambient thermal resistance ( $\theta_{JA}$ ) for device power dissipation ( $P_D$ ) consists primarily of two paths in series. The first path is the junction to the case ( $\theta_{JC}$ ) which is defined by the package style, and the second path is case to ambient ( $\theta_{CA}$ ) thermal resistance which is dependent on board layout. The final operating junction temperature for any set of conditions can be estimated by the following thermal equation:

$$\begin{aligned} T_{JUNC} &= T_{AMB} + P_D (\theta_{JC}) + P_D (\theta_{CA}) \\ &= T_{AMB} + P_D (\theta_{JA}) \end{aligned}$$

The CM3103 uses a thermally enhanced package where all the GND pins (5 through 8) are integral to the leadframe. When this package is mounted on a double-sided printed circuit board with two square inches of copper allocated for "heat spreading", the resulting  $\theta_{JA}$  is about 50°C/W.

Based on a typical operating power dissipation of 0.7W (1.75V x 0.4A) with an ambient of 70°C, the resulting junction temperature will be:

$$\begin{aligned} T_{JUNC} &= T_{AMB} + P_D (\theta_{JA}) \\ &= 70^\circ\text{C} + 0.7\text{W} \times (50^\circ\text{C/W}) \\ &= 70^\circ\text{C} + 35^\circ\text{C} = 105^\circ\text{C} \end{aligned}$$

Thermal characteristics were measured using a double-sided board with two square inches of copper area connected to the GND pin for "heat spreading".

Measurements showing performance up to junction temperature of 125°C were performed under light load conditions (5mA). This allows the ambient temperature to be representative of the internal junction temperature.

Note: The use of multi-layer board construction with separate ground and power planes will further enhance the overall thermal performance. In the event of no copper area being dedicated for heat spreading, a multi-layer board construction, using only the minimum size pad layout, will provide the CM3103 with an overall  $\theta_{JA}$  of 70°C/W which allows up to 780mW to be safely dissipated for the maximum junction temperature.

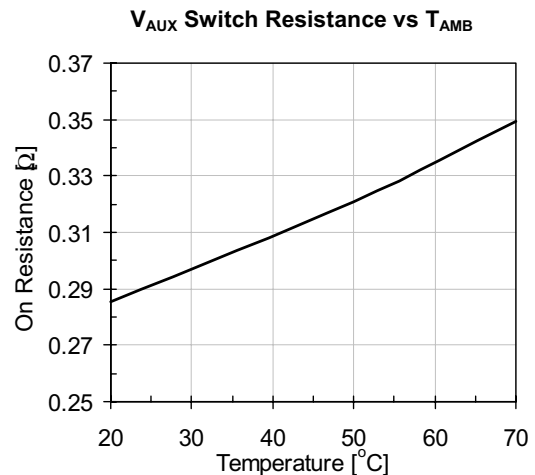
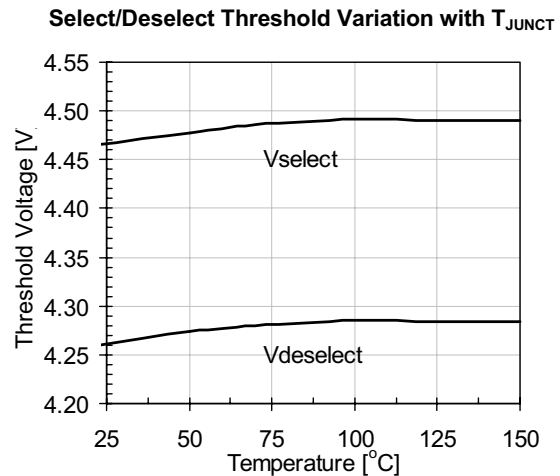
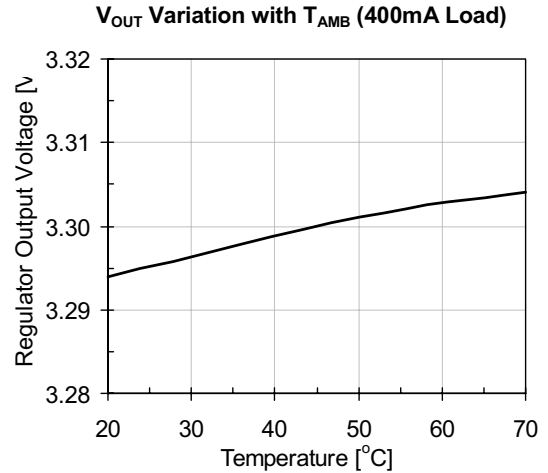



## Mechanical Details

### SOIC-8 Mechanical Specifications

Dimensions for CM3103 devices packaged in 8-pin SOIC packages are presented below.

For complete information on the SOIC-8 package, see the California Micro Devices SOIC Package Information document.

PACKAGE DIMENSIONS				
Package	SOIC			
Pins	8			
Dimensions	Millimeters		Inches	
	Min	Max	Min	Max
<b>A</b>	1.35	1.75	0.053	0.069
<b>A<sub>1</sub></b>	0.10	0.25	0.004	0.010
<b>B</b>	0.33	0.51	0.013	0.020
<b>C</b>	0.19	0.25	0.007	0.010
<b>D</b>	4.80	5.00	0.189	0.197
<b>E</b>	3.80	4.19	0.150	0.165
<b>e</b>	1.27 BSC		0.050 BSC	
<b>H</b>	5.80	6.20	0.228	0.244
<b>L</b>	0.40	1.27	0.016	0.050
<b># per tube</b>	100 pieces*			
<b># per tape and reel</b>	2500 pieces			
Controlling dimension: inches				

\* This is an approximate number which may vary.

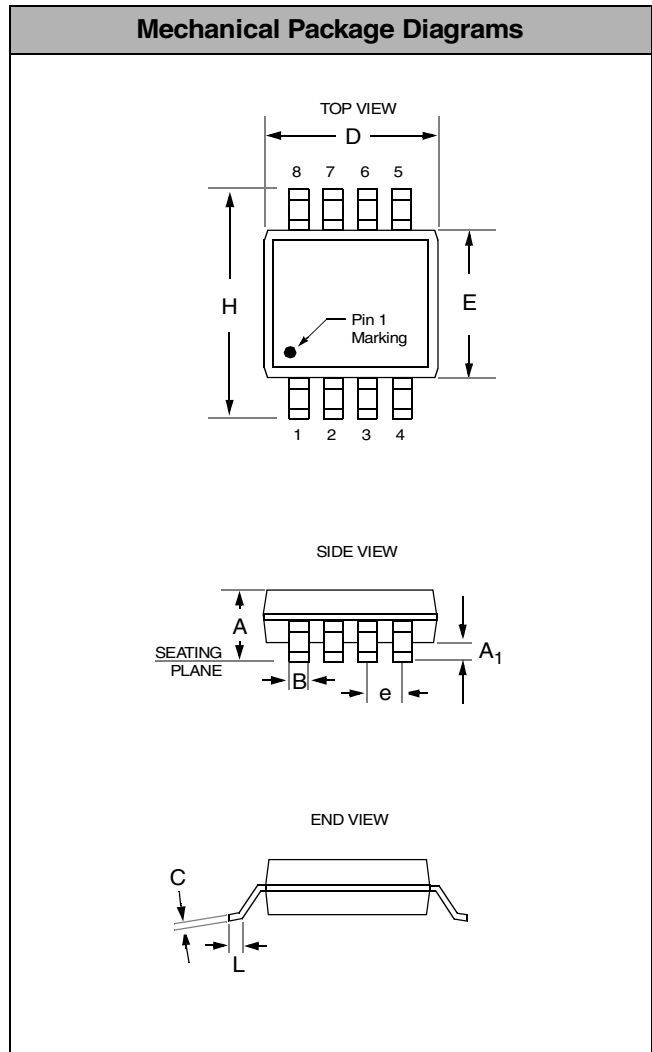

Package Dimensions for SOIC-8