

## USB 2.4A Overcurrent Switch

### Features

- High-side high current switch with active low Enable
- Up to 2.4A continuous current on the output
- Over-current limits at 2.4A min
- 10msec min fault blanking delay on OC# output prevents false overcurrent alarms
- Prevents backdrive current when host powered off
- Low operating current (95 $\mu$ A typ.)
- Low quiescent current when disabled (<1 $\mu$ A max)
- Small 8-Lead SOIC package

### Applications

- Desktop PCs, Notebooks and Set-Top-Boxes

### Product Description

California Micro Devices' CM3513 is a USB overcurrent power switch that provides power to four USB ports. The device has a power switch that provides the  $V_{BUS}$  voltage at the USB output ports with minimal voltage drop. When the EN# pin is logic low, the power switch is ON, and  $V_{CC}$  is connected to the output  $V_{OUT}$ . When the EN# pin is logic high, the power switch is OFF, and no power is available at the output.

The power switch has full over-current protection. Whenever the current limit of the switch is exceeded, the device enters a constant-current mode, where the output voltage is progressively reduced to prevent the current from increasing further. The OC# output becomes active low only if the overcurrent condition exceeds at least 10ms. This fault blanking delay prevents false alarms from being reported to the host USB controller.

If the overcurrent condition is severe enough that the part heats up to the thermal limit  $T_{MAX}$ , then the switch will be turned off and the temperature cools down. At  $T_{MIN}$  the switch then turns on again, and the device heats up again, and so on, until the fault is removed.

The CM3513 also prevents backdrive current flowing into the host from the connected peripheral. This can occur when  $V_{CC}$  is removed as the host powers down, and the peripheral still has normal power applied. The 5V from the peripheral can therefore be linked to the host's  $V_{BUS}$ , potentially causing backdrive current into the host and overloading the peripheral power supply.

### Pin Diagram

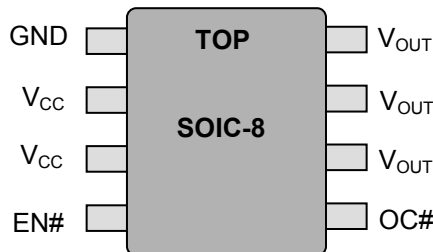

### Typical Application Circuit

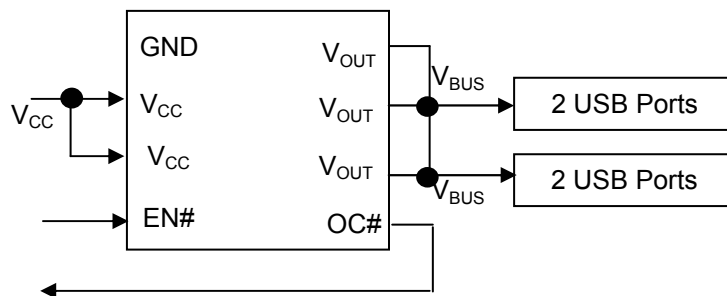

### Simplified Electrical Schematic

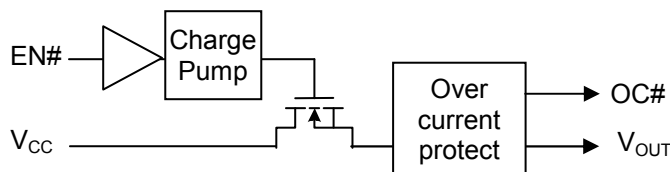



Absolute Maximum Ratings		
Parameter	Rating	Unit
ESD Protection (All pins, HBM)	± 2000	V
V <sub>CC</sub> Input Voltage	+ 5.6, Gnd - 0.5	V
Storage Temperature Range	-55 to +150	°C
Operating Ambient	-40 to +85	
Operating Junction	-40 to +150*	
Output Current Loading	Internally limited	A
Package Power Dissipation	0.5	W

\*Internally limited

Operating Conditions (unless specified otherwise)		
Parameter	Range	Unit
V <sub>CC</sub> Input Voltage	4.5 to 5.5	V
Ambient Temperature	-40 to +85	°C
I <sub>LOAD</sub>	0 to 2400	mA

Electrical Operating Characteristics (over operating conditions unless specified otherwise)						
Symbol	Parameter	Conditions	MIN	TYP	MAX	UNIT
UVLO	V <sub>CC</sub> voltage under which circuit locks out - will not operate			2.2	2.5	V
R <sub>SW</sub>	Switch ON-Resistance	I <sub>LOAD</sub> = 0 to 2400mA; V <sub>CC</sub> = 5V, T = 25°C		0.07	0.1	Ω
R <sub>SWa</sub>	Switch ON-Resistance	I <sub>LOAD</sub> = 0 to 2400mA; V <sub>CC</sub> = 5V, T = 0 to +85°C			0.125	Ω
R <sub>SWb</sub>	Switch ON-Resistance	I <sub>LOAD</sub> = 0 to 2400mA; V <sub>CC</sub> = 5V, T = -40 to +85°C			0.125	Ω
V <sub>OUT</sub>	Output Voltage	I <sub>LOAD</sub> = 1000mA, V <sub>CC</sub> = 5.0V, EN# = 0V, T = 25°C	4.9			V
I <sub>LIM</sub>	Over-current limit	V <sub>CC</sub> = 5V T = 25°C	2400	3000	3800	mA
t <sub>FBD</sub>	Time delay from overcurrent detection to OC# output indication (fault blanking delay)		10	20	30	ms
T <sub>MAX</sub>	Temperature at which switch turns off during overcurrent			150		°C
T <sub>MIN</sub>	Temperature at which switch turns on, after cooling from T <sub>MAX</sub>			125		°C
I <sub>RCC</sub>	Reverse leakage from output to input	V <sub>CC</sub> = 0V, V <sub>OUT</sub> = 5V, EN# = high, T = 25°C		1		μA
I <sub>CC</sub>	Operating supply current	EN# = low		95		μA
I <sub>CCQ</sub>	Quiescent current	EN# = high T = 25°C			1	μA
V <sub>IH-EN</sub>	EN# input Logic-1 threshold	V <sub>CC</sub> = 5V	2			V
V <sub>IL-EN</sub>	EN# input Logic-0 threshold	V <sub>CC</sub> = 5V			0.8	V
I <sub>OHZ-OC</sub>	OC# output OFF state leakage	V <sub>CC</sub> = 5V, V <sub>OUT</sub> = 5V			1.0	uA
V <sub>OL-OC</sub>	OC# output Logic-0 threshold	I <sub>OC</sub> = 1mA			0.4	V

Note: This is a preliminary datasheet only. Data subject to change at any time.  
© 2003 California Micro Devices Corp. All rights reserved

## Pin Functions

**V<sub>CC</sub>** is the power source.

Pins 2 & 3 must be connected together externally

**V<sub>OUT</sub>** provides the power for the loads. The internal MOSFET switch is designed for very low voltage drops from the voltage input pins at the full rated current.

Pins 6, 7 & 8 must be connected together externally.

Current loads of up to 2.4A are allowed. Current loads above 2.4A may cause the constant-current limiting circuit to operate – reducing the output voltage.

Continuous over-current loads will cause the part's internal temperature to rise. If the internal temperature exceeds 150°C then the switch immediately turns off. Once the part has cooled to 125°C then the switch automatically turns on again.

During the cold-start interval when the input is initially applied, internal circuitry provides a soft turn-on for the switch, which limits peak in-rush current.

**EN#** is the active low logic input pin that is used to control the power switch. Set EN# high (>2V) to deselect V<sub>OUT</sub>, and set EN# low (<0.8V) to select V<sub>OUT</sub>.

**OC#** is an active low open-drain output voltage, indicating an overcurrent fault condition has been detected at V<sub>OUT</sub>. There is a built-in 10msec (min.) fault blanking delay after the overcurrent fault condition has been detected, before this output becomes active low. The OC# output deasserts only when both the overcurrent condition stops and when the voltage drop across the switch is less than 1V. An external pull-up resistor of 10k - 100k is required if the OC# output is used.

**GND** is the negative reference for all voltages.

### Pin Descriptions

Pin No.	Symbol	Description
1	GND	Negative reference for all voltages.
2	V <sub>CC</sub>	Power Primary High current Positive supply input.
3	V <sub>CC</sub>	Power supply input connected to pin 2
4	EN#	Active low enable pin
5	OC#	Active low when V <sub>OUT</sub> is in overcurrent mode. External pull-up resistor required.
6	V <sub>OUT</sub>	Output connected to pins 7 and 8
7	V <sub>OUT</sub>	Output connected to pins 6 and 8
8	V <sub>OUT</sub>	Output connected to pins 6 and 7

### STANDARD PART ORDERING INFORMATION

Pins	Package	Ordering Part Number <sup>1</sup>	Part Marking
8	SOIC	CM3513-04SN	CM3513-04SN

Note 1: Parts are shipped in Tape & Reel form unless otherwise specified.



### Response to Momentary Overcurrent Fault

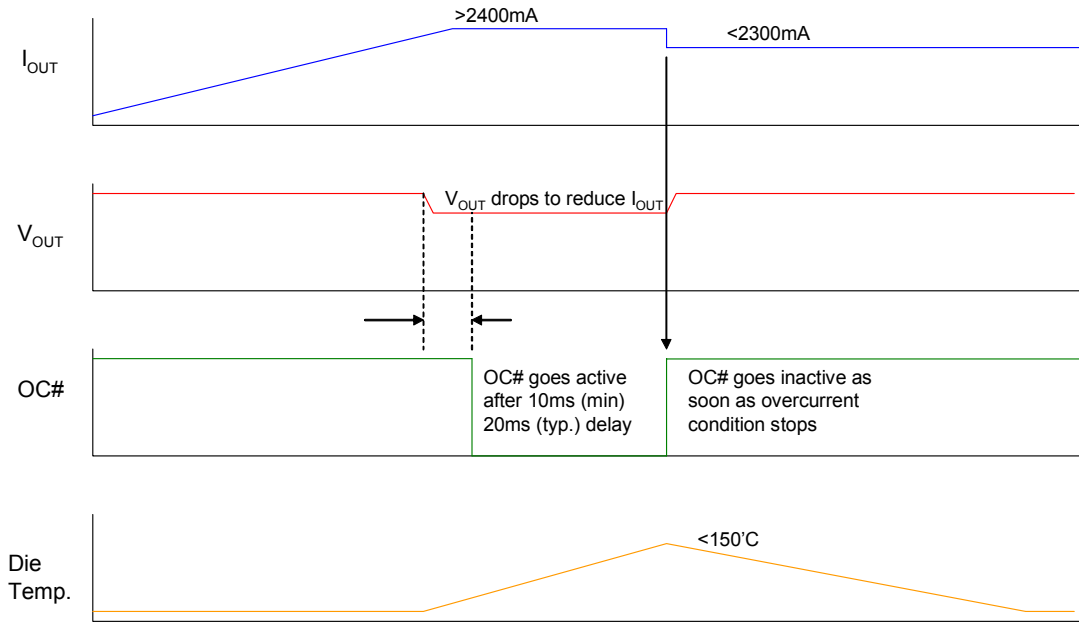

### Response to Continuous Overcurrent Fault

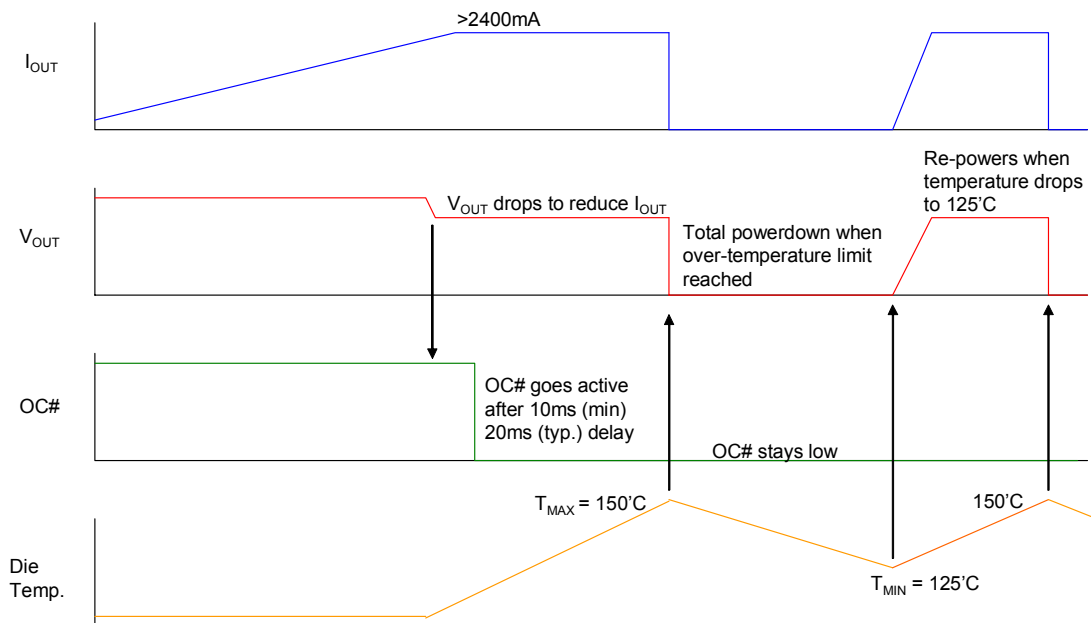

Note: This is a preliminary datasheet only. Data subject to change at any time.  
© 2003 California Micro Devices Corp. All rights reserved



### Typical Operating characteristics

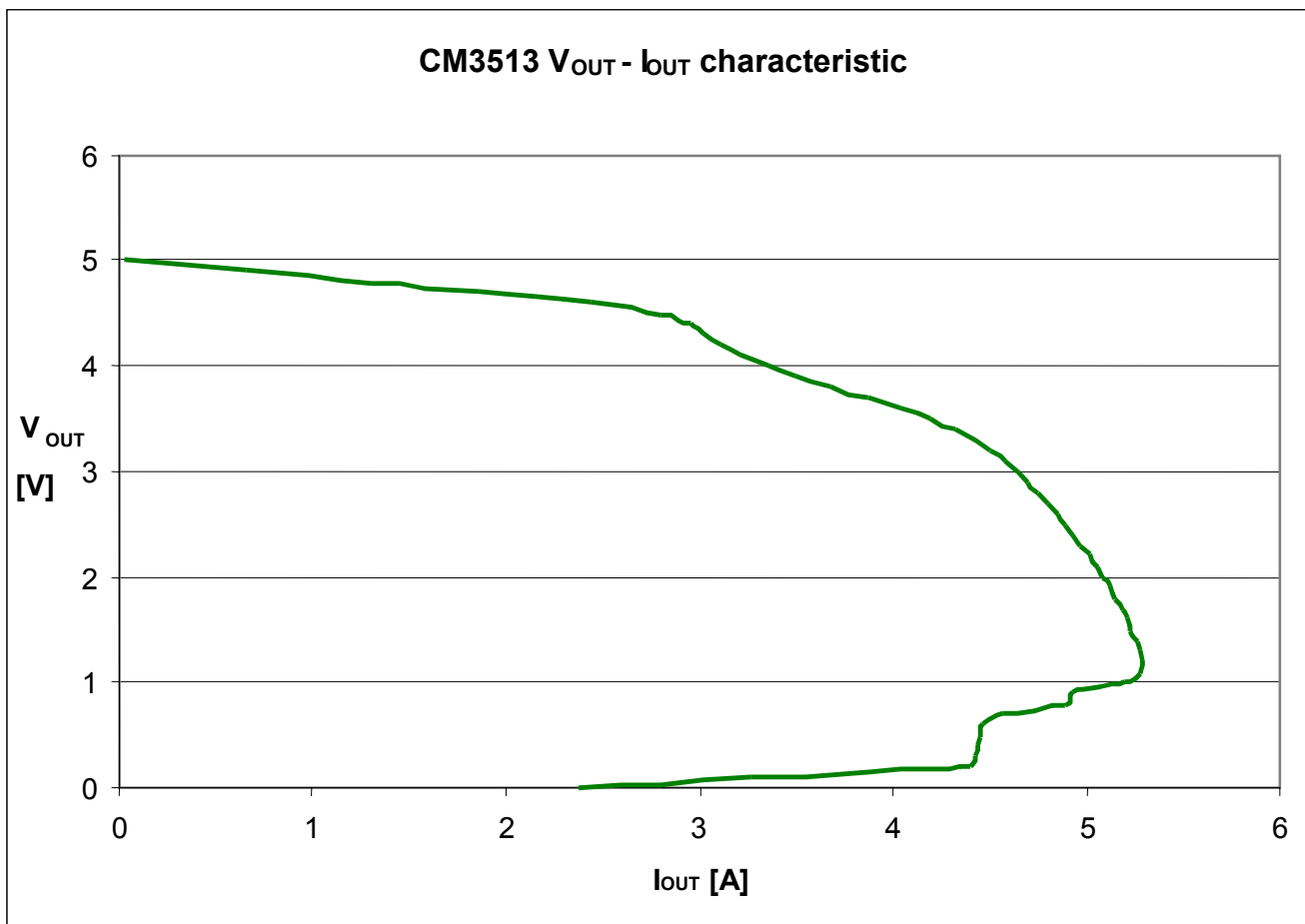
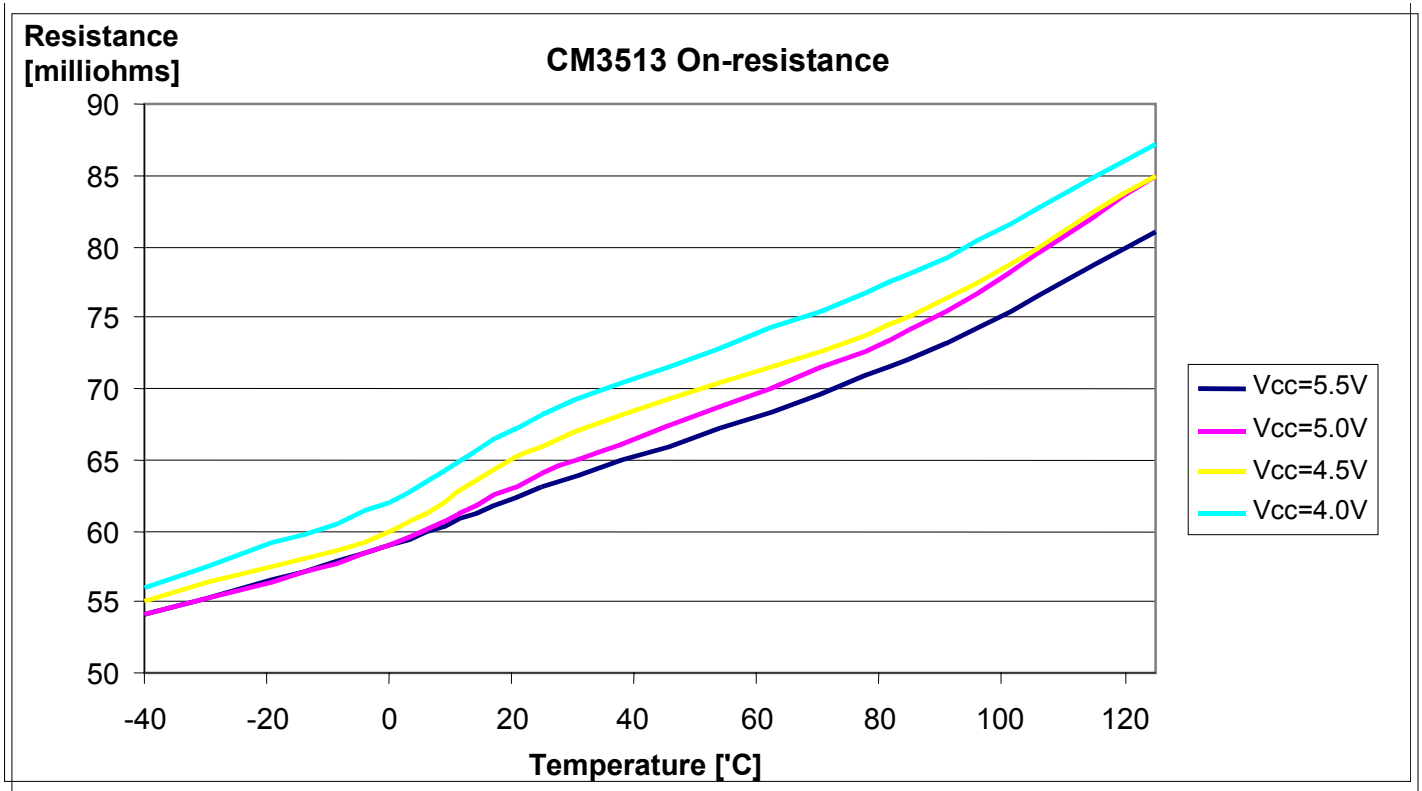

Note: This is a preliminary datasheet only. Data subject to change at any time.  
© 2003 California Micro Devices Corp. All rights reserved

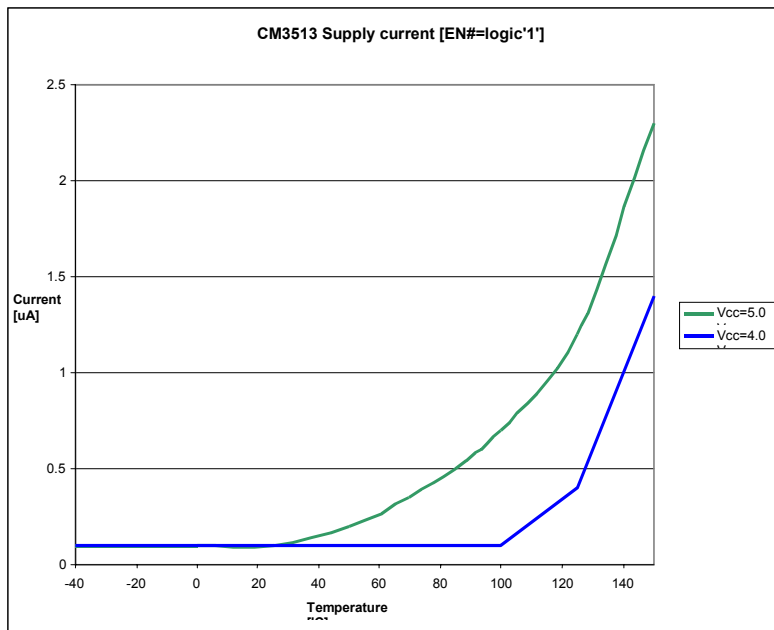
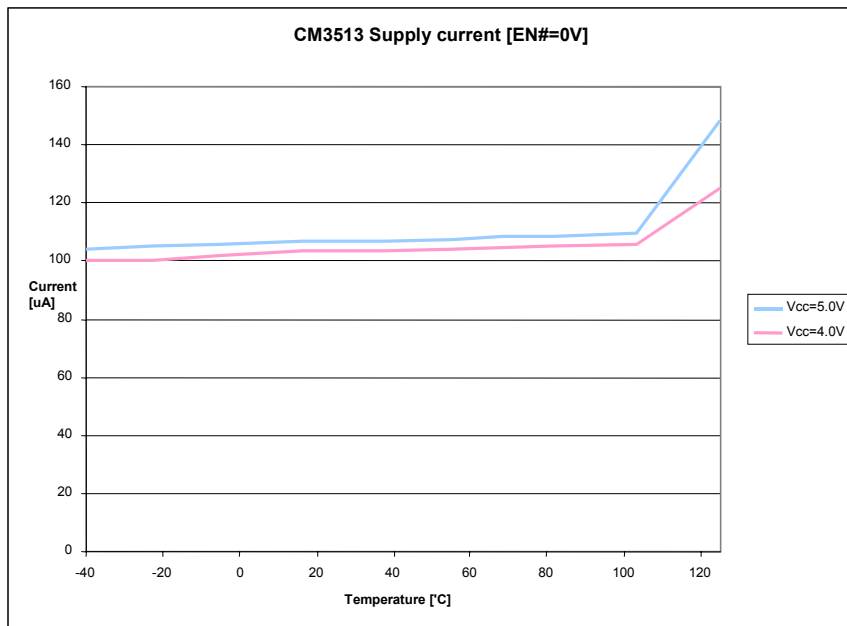
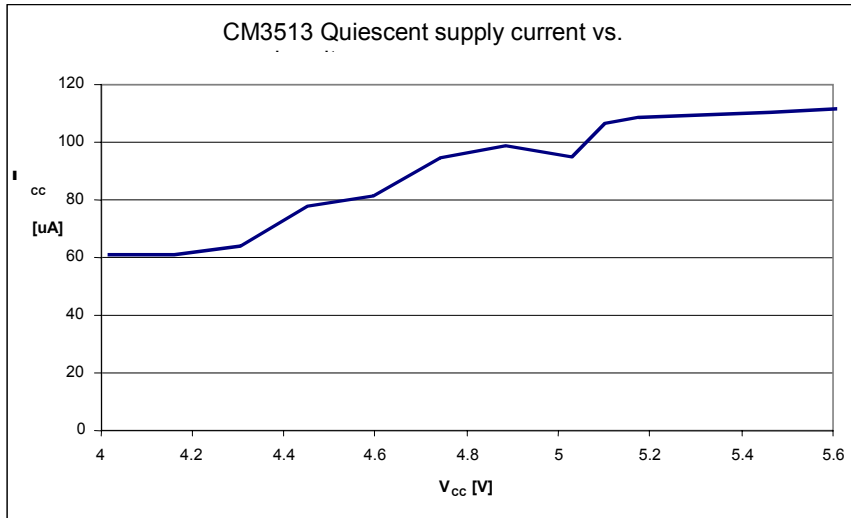

Note: This is a preliminary datasheet only. Data subject to change at any time.  
© 2003 California Micro Devices Corp. All rights reserved

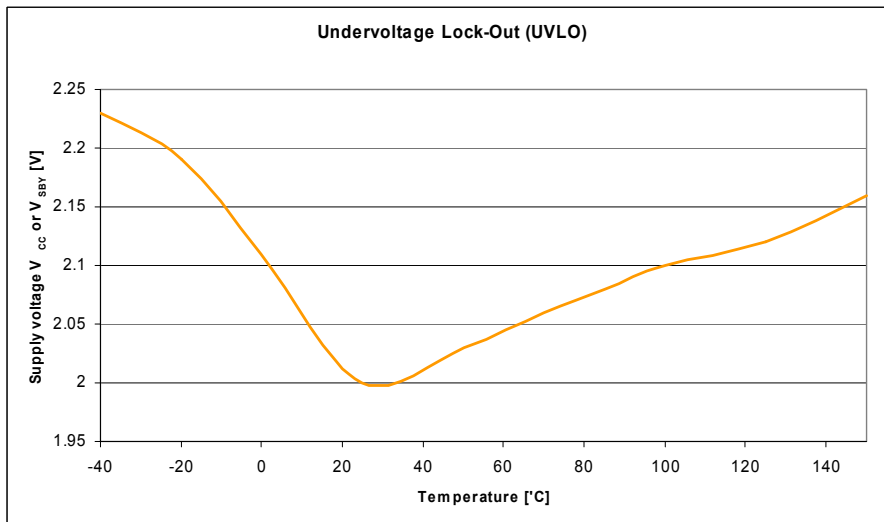
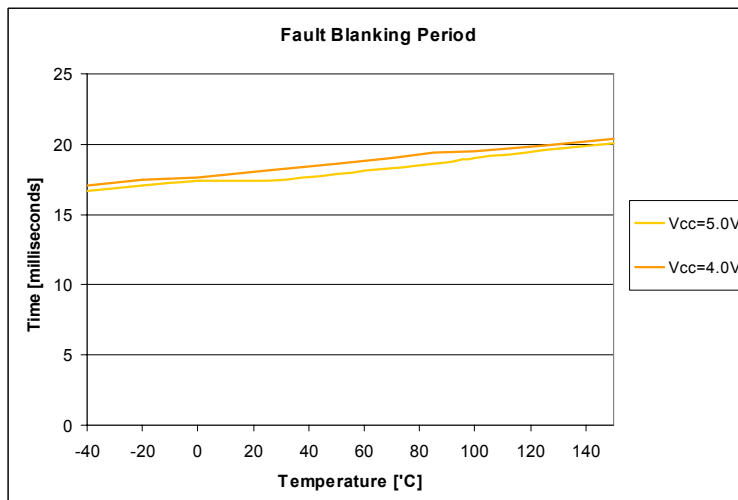
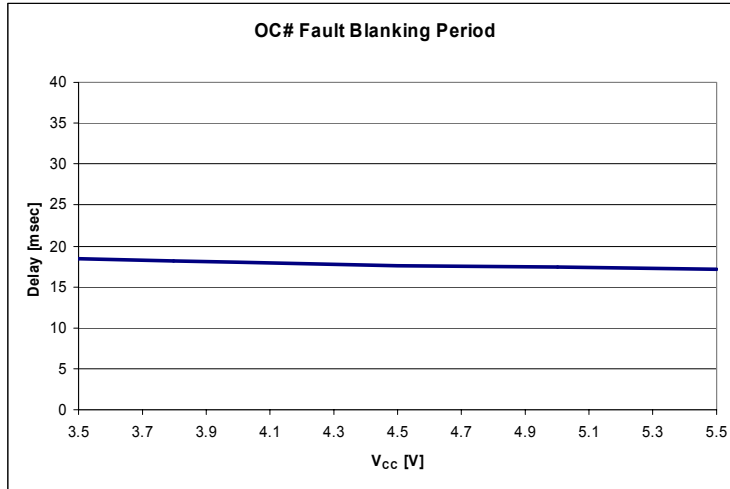

Note: This is a preliminary datasheet only. Data subject to change at any time.  
© 2003 California Micro Devices Corp. All rights reserved

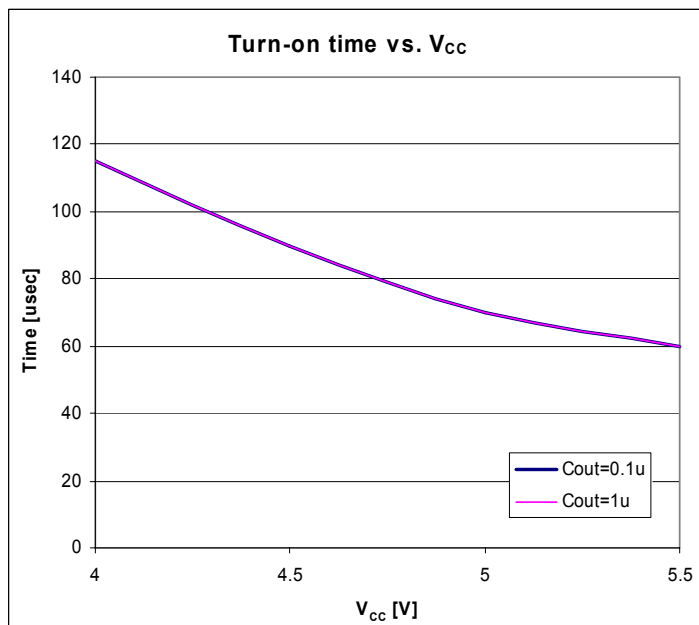
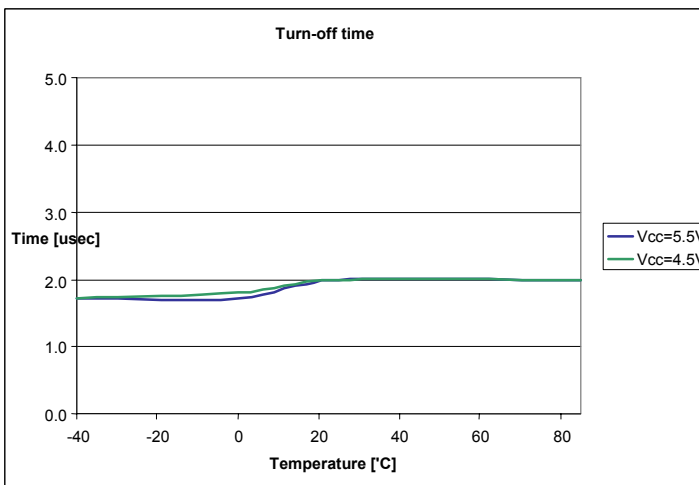
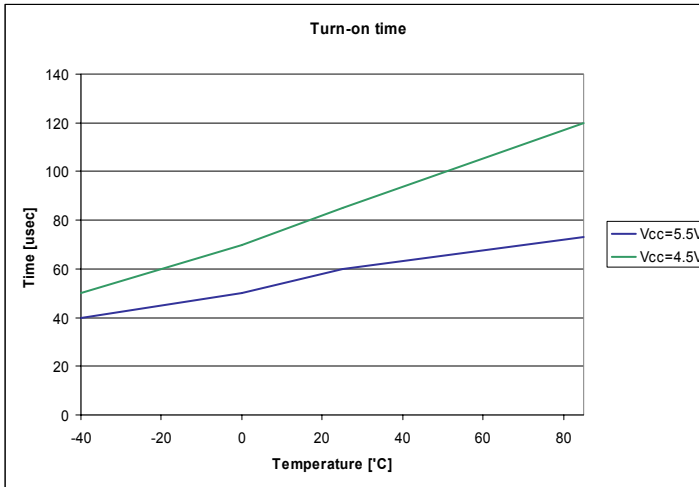

Note: This is a preliminary datasheet only. Data subject to change at any time.  
© 2003 California Micro Devices Corp. All rights reserved



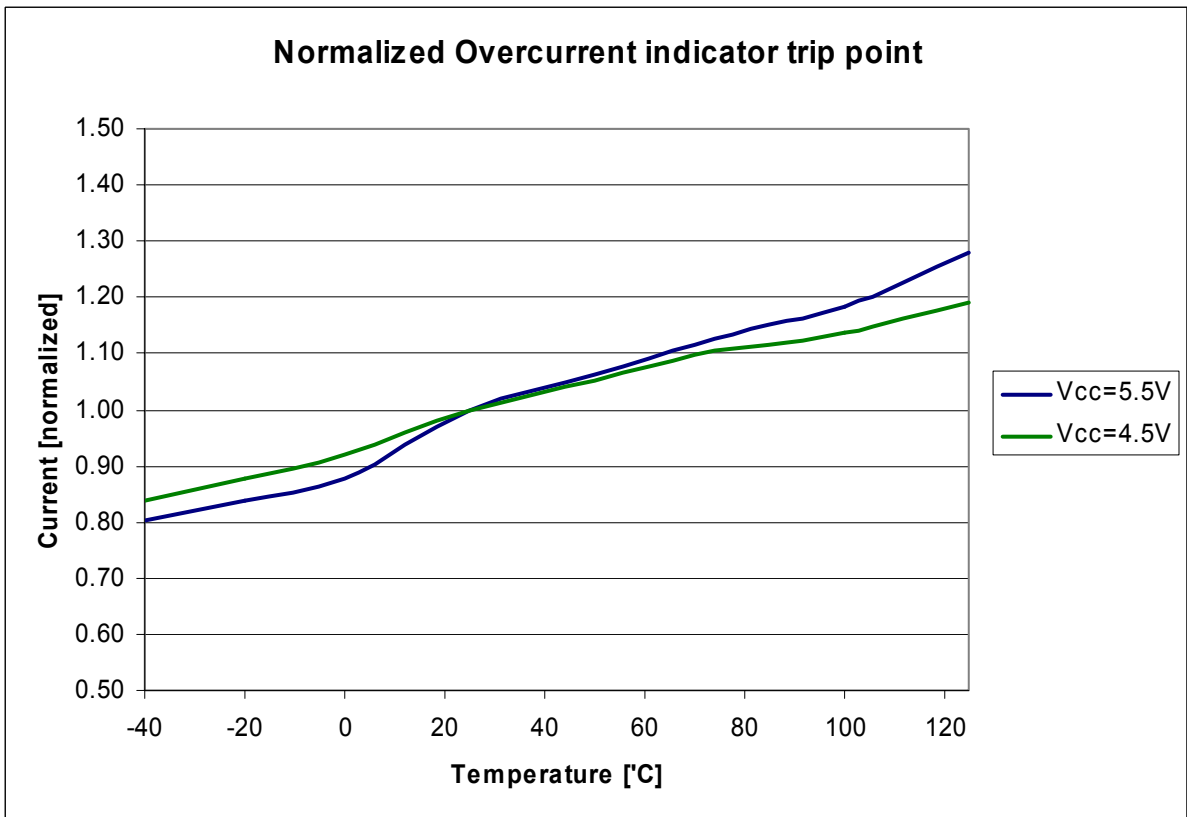
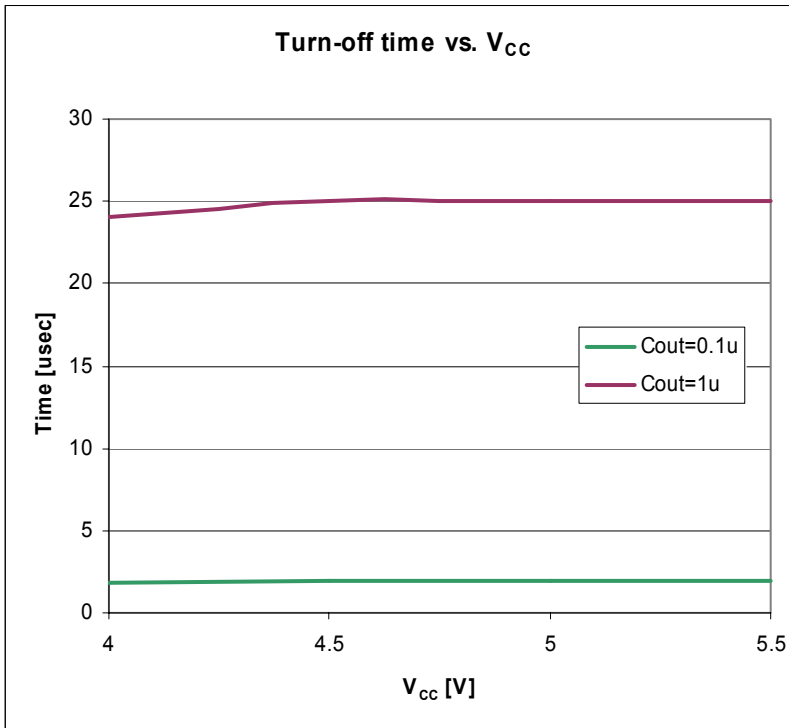

Note: This is a preliminary datasheet only. Data subject to change at any time.  
© 2003 California Micro Devices Corp. All rights reserved



### SOIC-8 Package Dimensions

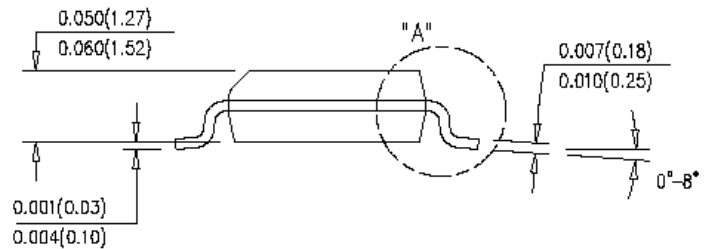
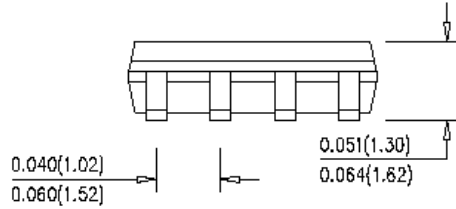
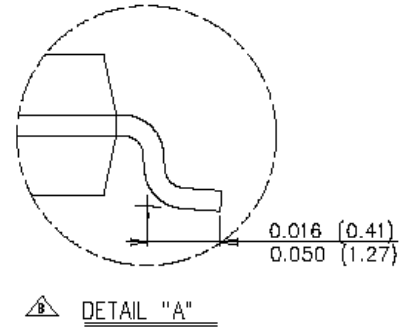
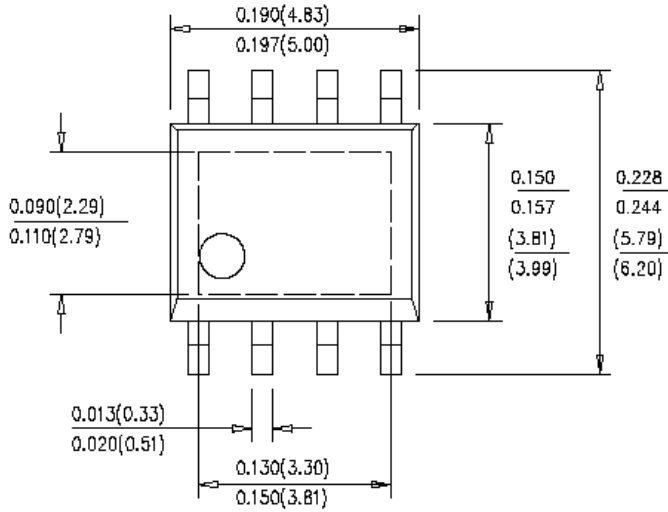

Note: This is a preliminary datasheet only. Data subject to change at any time.  
© 2003 California Micro Devices Corp. All rights reserved