

### Trench Gate Design Single IGBTMOD™ 600 Amperes/250 Volts

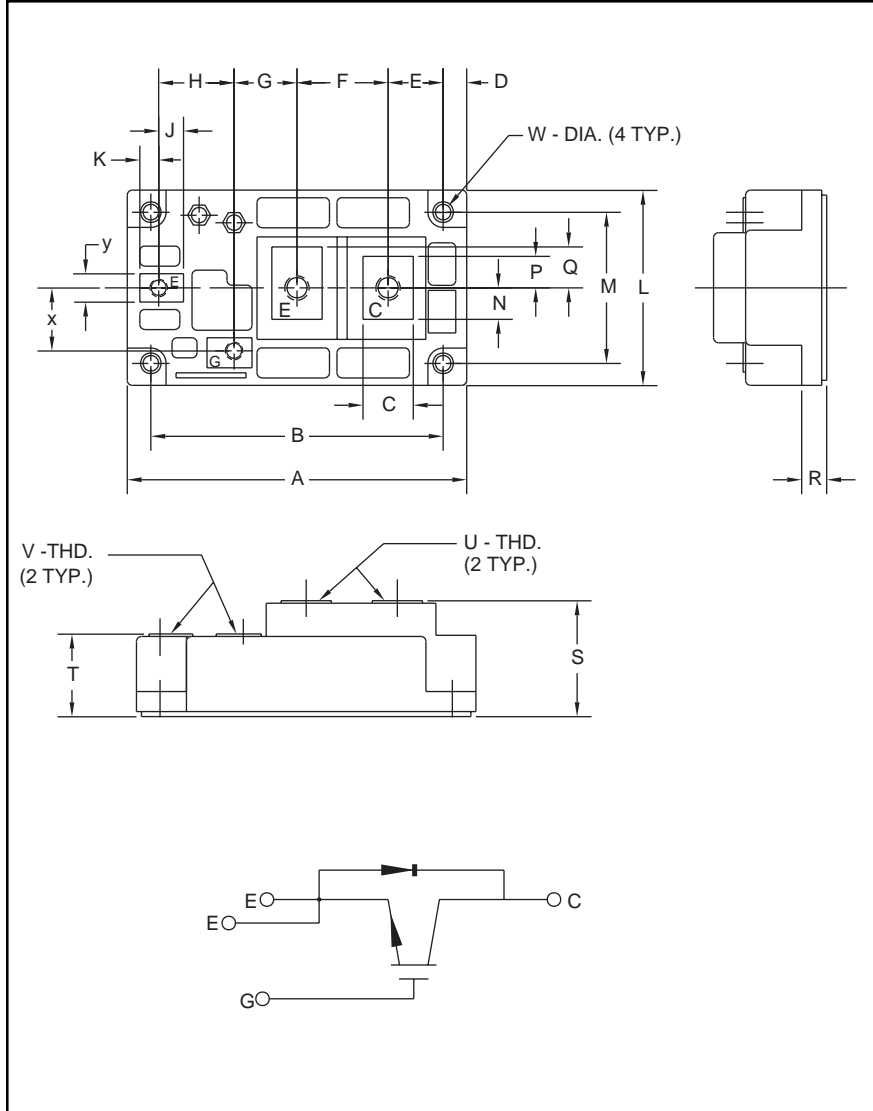

Outline Drawing and Circuit Diagram

Dimensions	Inches	Millimeters
A	4.25	108.0
B	3.66	93.0
C	0.63	16.0
D	0.30	7.5
E	0.69	17.5
F	1.14	29.0
G	0.79	20.0
H	0.94	24.0
J	0.31	7.9
K	0.24	6.0
L	2.44	62.0
M	1.89	48.0

Dimensions	Inches	Millimeters
N	0.39	10.0
P	0.39	10.0
Q	0.51	13.0
R	0.33	8.5
S	1.42	36.0
T	1.02	25.8
U	M6 Metric	M6
V	M4 Metric	M4
W	0.22	5.5
X	0.79	20.0
Y	0.35	9.0



#### Description:

Powerex IGBTMOD™ Modules are designed for use in switching applications. Each module consists of one IGBT Transistor in a single configuration, with a reverse connected super-fast recovery free-wheel diode. All components and interconnects are isolated from the heat sinking baseplate, offering simplified system assembly and thermal management.

#### Features:

- Low Drive Power
- Low  $V_{CE(sat)}$
- Discrete Super-Fast Recovery Free-Wheel Diodes
- High Frequency Operation (20-25 kHz)
- Isolated Baseplate for Easy Heat Sinking

#### Applications:

- DC Chopper
- Inverter
- UPS
- Forklift

#### Ordering Information:

Example: Select the complete nine digit module part number you desire from the table below - i.e. CM600HA-5F is a 250V ( $V_{CES}$ ), 600 Ampere Single IGBTMOD™ Power Module.

Type	Current Rating Amperes	$V_{CES}$ Volts (x 50)
CM	600	5

**CM600HA-5F**  
**Trench Gate Design Single IGBTMOD™**  
 600 Amperes/250 Volts

**Absolute Maximum Ratings,  $T_j = 25^\circ\text{C}$  unless otherwise specified**

Characteristics	Symbol	CM600HA-5F	Units
Junction Temperature	$T_j$	-40 to 150	$^\circ\text{C}$
Storage Temperature	$T_{\text{stg}}$	-40 to 125	$^\circ\text{C}$
Collector-Emitter Voltage (G-E Short)	$V_{\text{CES}}$	250	Volts
Gate-Emitter Voltage (C-E Short)	$V_{\text{GES}}$	$\pm 20$	Volts
Collector Current	$I_C$	600	Amperes
Peak Collector Current	$I_{\text{CM}}$	1200	Amperes
Diode Forward Current	$I_F$	600	Amperes
Diode Forward Surge Current	$I_{\text{FM}}$	1200	Amperes
Power Dissipation	$P_d$	960	Watts
Maximum Mounting Torque, M6 Terminal Screws	—	26	in-lb
Maximum Mounting Torque, M6 Mounting Screws	—	26	in-lb
Maximum Mounting Torque, M4 (G, E) Terminal Screws	—	13	in-lb
Module Weight (Typical)	—	400	Grams
Isolation Voltage, AC 1 minute, 60Hz	$V_{\text{RMS}}$	2500	Volts

**Static Electrical Characteristics,  $T_j = 25^\circ\text{C}$  unless otherwise specified**

Characteristics	Symbol	Test Conditions	Min.	Typ.	Max.	Units
Collector-Cutoff Current	$I_{\text{CES}}$	$V_{\text{CE}} = V_{\text{CES}}, V_{\text{GE}} = 0\text{V}$	—	—	1.0	mA
Gate Leakage Current	$I_{\text{GES}}$	$V_{\text{GE}} = V_{\text{GES}}, V_{\text{CE}} = 0\text{V}$	—	—	0.5	$\mu\text{A}$
Gate-Emitter Threshold Voltage	$V_{\text{GE(th)}}$	$I_C = 60\text{mA}, V_{\text{CE}} = 10\text{V}$	3.0	4.0	5.0	Volts
Collector-Emitter Saturation Voltage	$V_{\text{CE(sat)}}$	$I_C = 600\text{A}, V_{\text{GE}} = 10\text{V}$	—	1.2	1.7	Volts
		$I_C = 600\text{A}, V_{\text{GE}} = 10\text{V}, T_j = 150^\circ\text{C}$	—	1.1	—	Volts
Total Gate Charge	$Q_G$	$V_{\text{CC}} = 50\text{V}, I_C = 600\text{A}, V_{\text{GS}} = 10\text{V}$	—	2200	—	nC
Diode Forward Voltage	$V_{\text{FM}}$	$I_E = 600\text{A}, V_{\text{GS}} = 0\text{V}$	—	—	2.0	Volts

**Dynamic Electrical Characteristics,  $T_j = 25^\circ\text{C}$  unless otherwise specified**

Characteristics	Symbol	Test Conditions	Min.	Typ.	Max.	Units
Input Capacitance	$C_{\text{IES}}$		—	—	165	nF
Output Capacitance	$C_{\text{OES}}$	$V_{\text{GE}} = 0\text{V}, V_{\text{CE}} = 10\text{V}$	—	—	7.5	nF
Reverse Transfer Capacitance	$C_{\text{RES}}$		—	—	5.6	nF
Resistive	Turn-on Delay Time	$t_{\text{d(on)}}$	—	—	1000	ns
Load	Rise Time	$t_r$	—	—	4000	ns
	Turn-off Delay Time	$t_{\text{d(off)}}$	—	—	1000	ns
Switching	Fall Time	$t_f$	—	—	500	ns
Diode Reverse Recovery Time	$t_{\text{rr}}$	$I_E = 600\text{A}, di_E/dt = -1200\text{A/ms}$	—	—	300	ns
Diode Reverse Recovery Charge	$Q_{\text{rr}}$	$I_E = 600\text{A}, di_E/dt = -1200\text{A/ms}$	—	9.5	—	$\mu\text{C}$

**Thermal and Mechanical Electrical Characteristics,  $T_j = 25^\circ\text{C}$  unless otherwise specified**

Characteristics	Symbol	Test Conditions	Min.	Typ.	Max.	Units
Thermal Resistance, Junction to Case	$R_{\text{th(j-c)}}$	Per IGBT	—	—	0.13	$^\circ\text{C/W}$
Thermal Resistance, Junction to Case	$R_{\text{th(j-c)}}$	Free Wheel Diode	—	—	0.19	$^\circ\text{C/W}$
Contact Thermal Resistance	$R_{\text{th(c-f)}}$	Per Module, Thermal Grease Applied	—	—	0.040	$^\circ\text{C/W}$



Powerex, Inc., 200 Hillis Street, Youngwood, Pennsylvania 15697-1800 (724) 925-7272

**CM600HA-5F**  
**Trench Gate Design Single IGBTMOD™**  
 600 Amperes/250 Volts

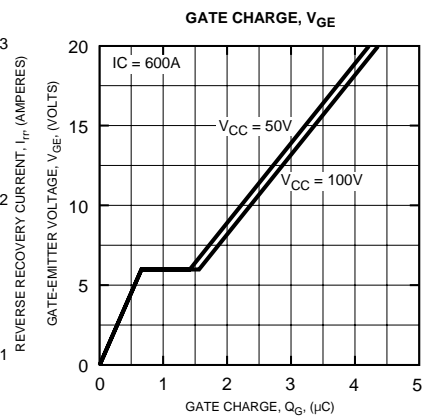
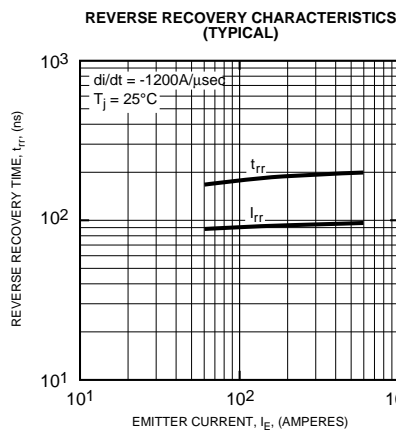
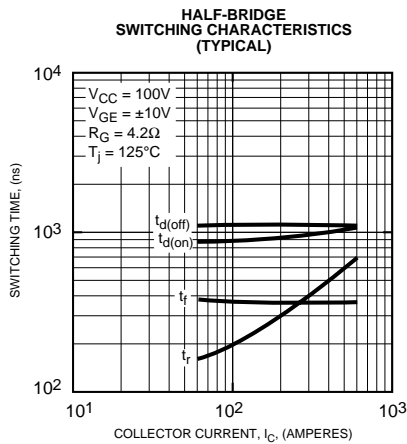
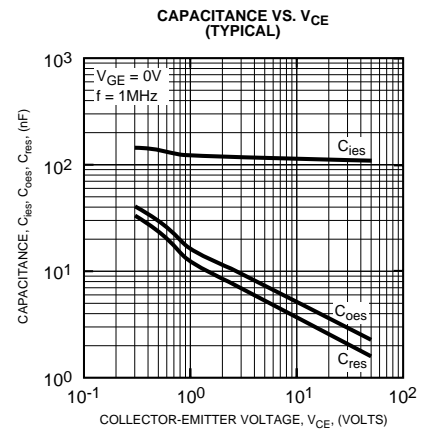
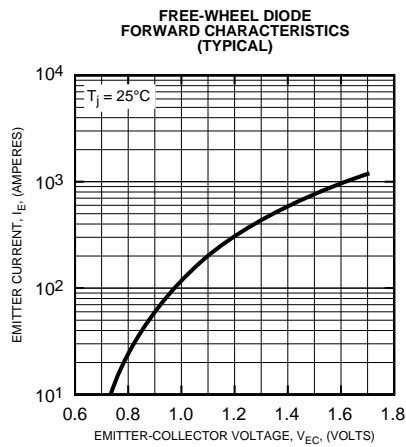
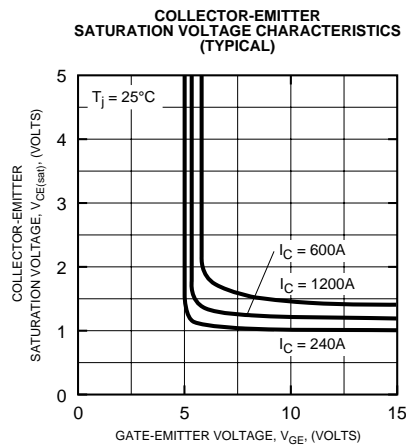
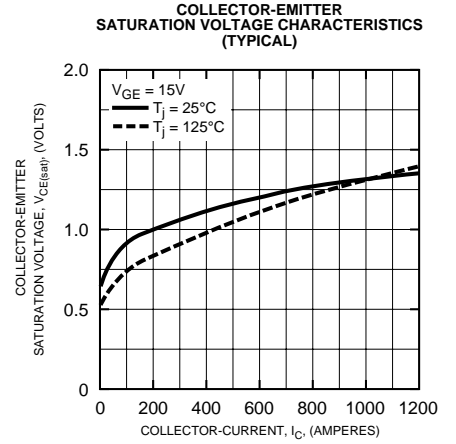
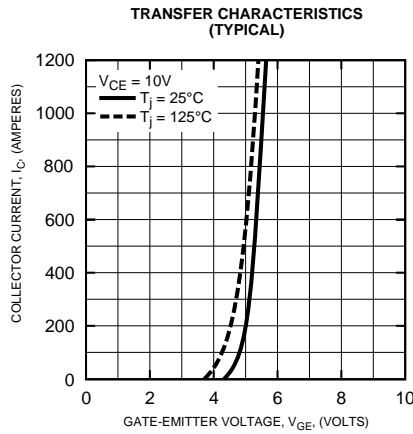
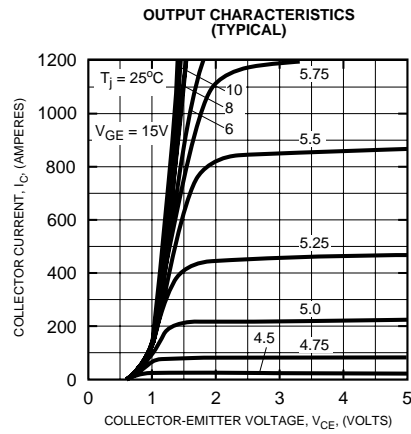

**CM600HA-5F**  
**Trench Gate Design Single IGBTMOD™**  
 600 Amperes/250 Volts

