

# 5.0-14.0 GHz GaAs MMIC Packaged Driver Amplifier

## Features

- ✕ 20 dB Gain
- ✕ 11 dBm P1dB
- ✕ 3x3 QFN Package
- ✕ Single Power Supply
- ✕ 5-7 V, 90 mA Self Bias
- ✕ On-Chip ESD Protection

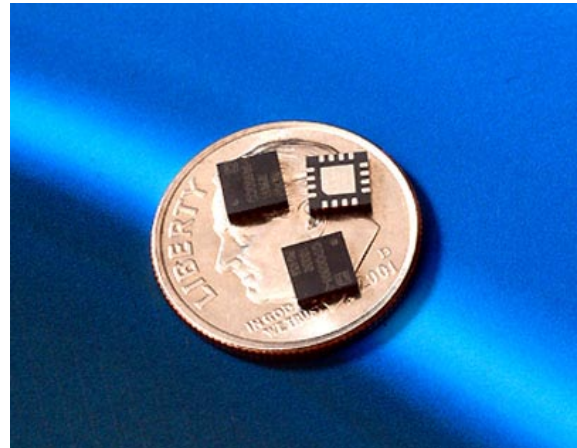

## Circuit Description

Mimix Broadband's 3 stage 5.0 to 14.0 GHz driver amplifier is packaged in surface mount 3x3 QFN package. The device is a self-biased, single supply design with 20 dB gain and 11 dBm P1dB. This MMIC uses Mimix Broadband's 0.25um optical pHEMT process.

## Absolute Maximum Ratings

Supply Voltage	+8 V
RF Input Power	+10 dBm
Storage Temperature (Tstg)	-55 °C to +125 °C
Junction Temperature	175 °C
Operating Temperature	-40 °C to +85°C

Operating this device beyond any of these parameters may cause permanent damage.

## Electrical Characteristics (T=25°C)

Parameter	Units	Min.	Typ.	Max.
Frequency Range	GHz	5	-	14
Gain	dB	-	20	-
Input Return Loss		-	-12	-
Output P1dB	dBm	-	11	-
Output IP3	dBm	-	22	-
Supply Voltage	V	-	5	7
Current	mA		90	120

## Typical Parameters (6V, 90 mA)

Parameter	Typical					
	5	7	9	11	13	14
Frequency	5	7	9	11	13	14
Gain	20.5	20.5	18.5	18.5	18.5	20
IP Return Loss	-15	-15	-17	-20	-10	-8
Op Return Loss	-14.5	-15	-11	-11	-9	-9
P1dB	13	13	10	10	10	11.5
OIP3	24.0	24.0	22.0	20.0	21.0	20.5

# 5.0-14.0 GHz GaAs MMIC Packaged Driver Amplifier



February 2007 - Rev 02-Feb-07

**CMM0511-QT**  
RoHS

## Driver Amplifier Measurements

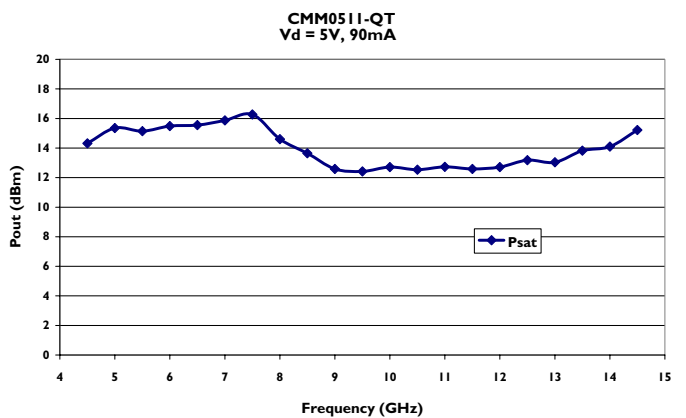
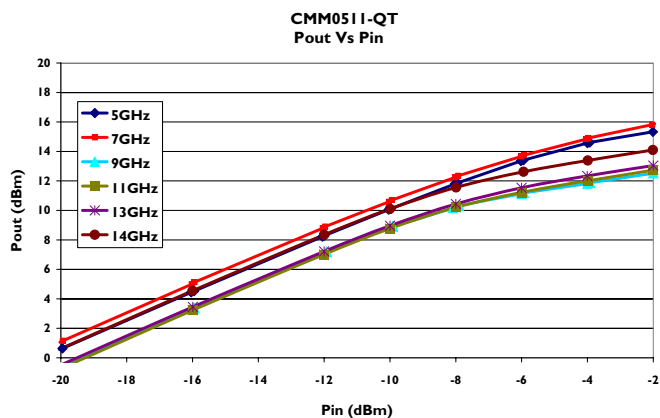
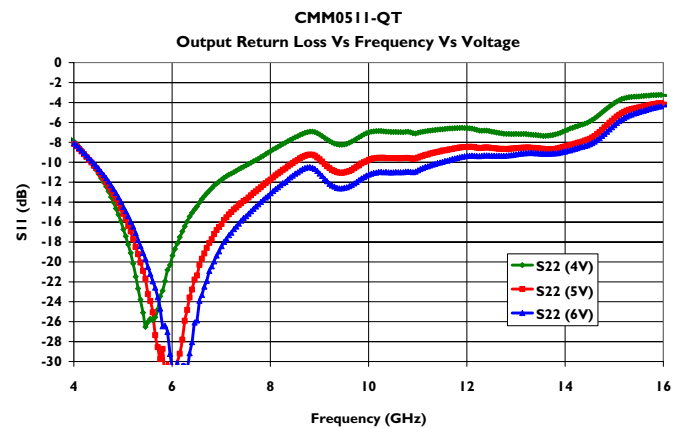
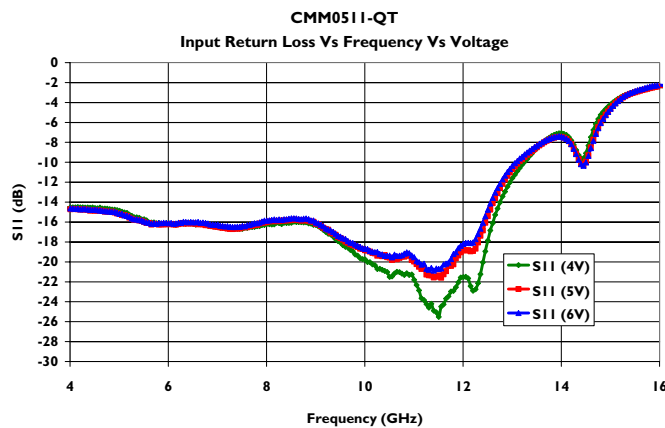
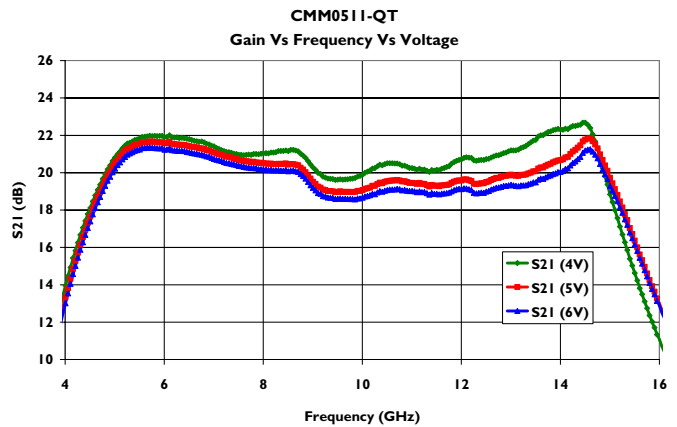
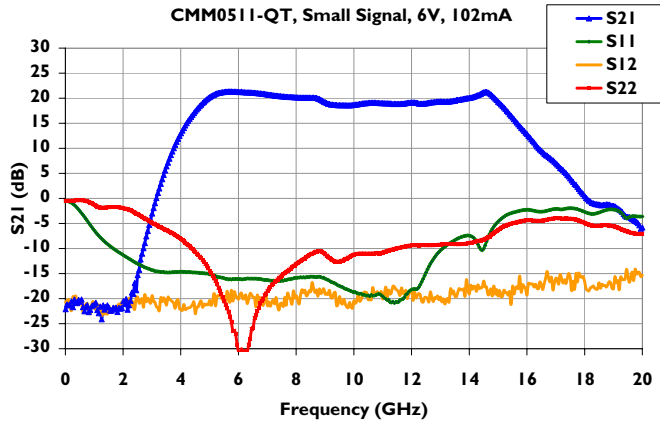

# 5.0-14.0 GHz GaAs MMIC Packaged Driver Amplifier



February 2007 - Rev 02-Feb-07

**CMM0511-QT**  
RoHS

## Driver Amplifier Measurements (cont.)

Gain Vs Frequency Vs Temperature  
5V, 90mA

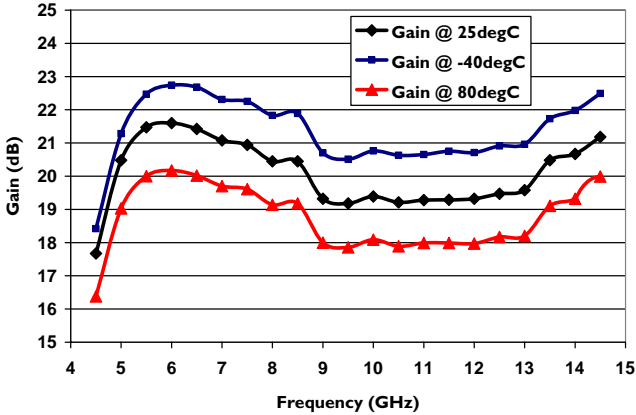

Gain Vs Frequency Vs Temperature  
6V, 90mA

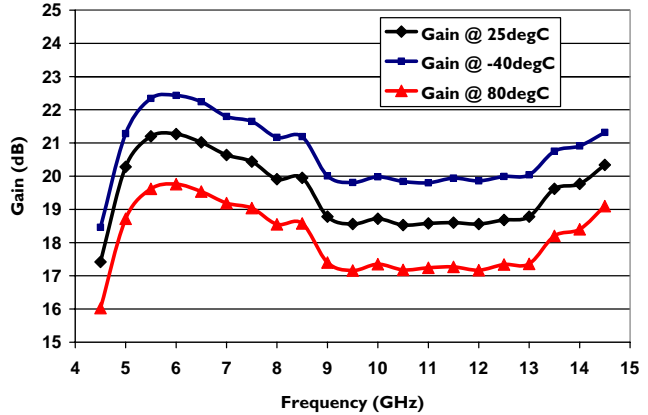

PI dB Vs Frequency Vs Temperature  
5V, 90mA

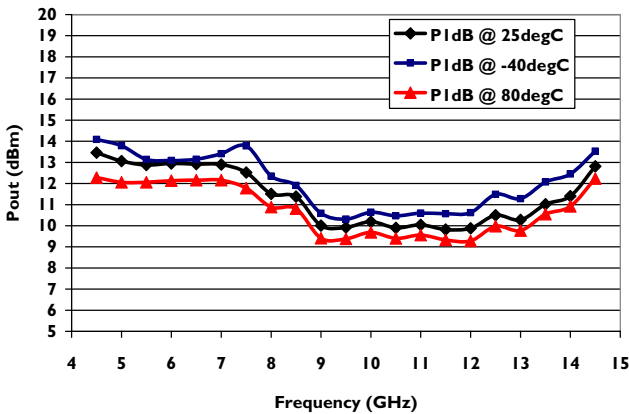

PI dB Vs Frequency Vs Temperature  
6V, 90mA

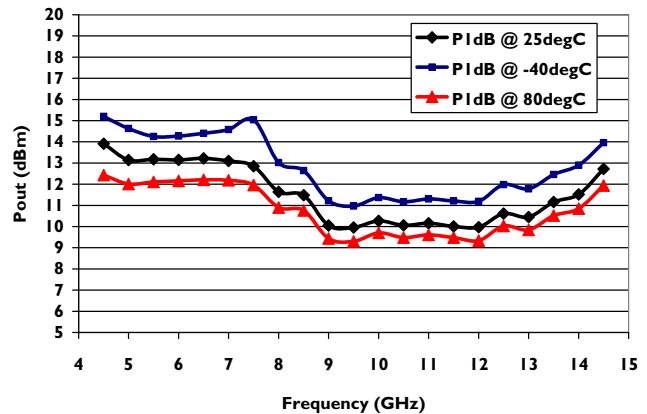

OIP3 Vs Frequency Vs Temperature  
5V, 90mA

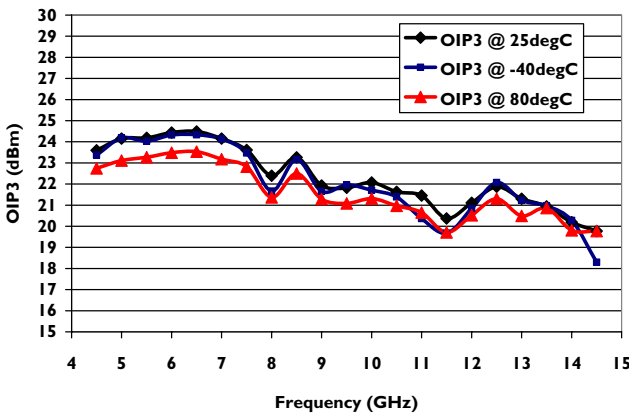

OIP3 Vs Frequency Vs Temperature  
6V, 90mA

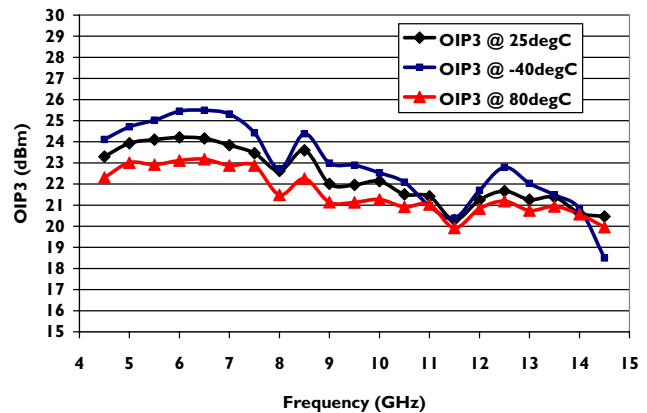

# 5.0-14.0 GHz GaAs MMIC Packaged Driver Amplifier

## Evaluation Board Layout

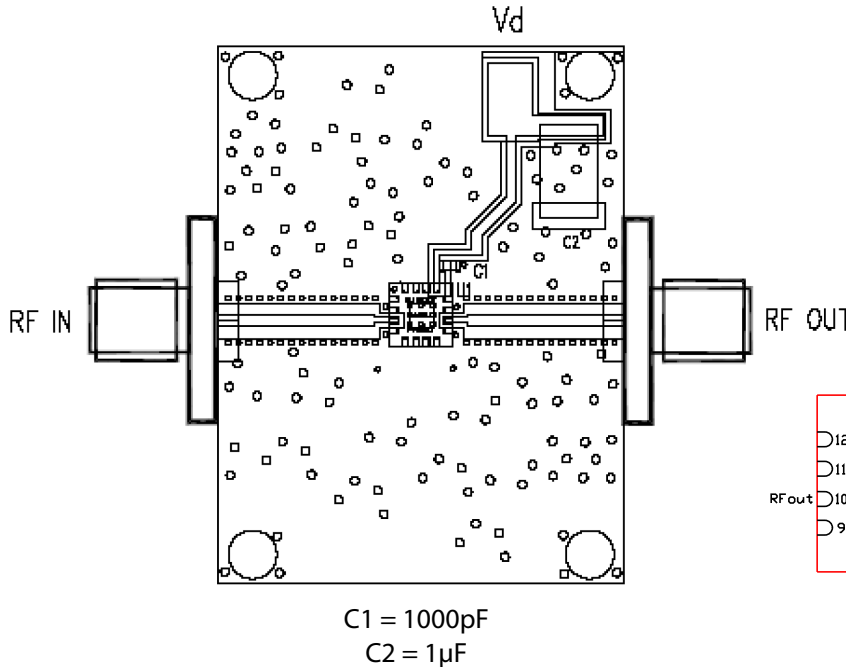

## Package Pin-out Table

Pin Designator	Description
1,2,4,5,6,7,8,9, 11,12,14,15,16	NC
3	RF Input
10	RF Output
13	Vd

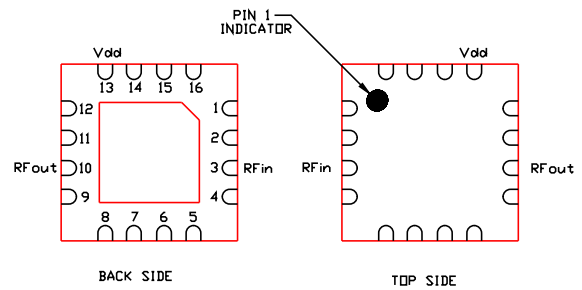

We recommend to ground all non-connected pins and to have as many via holes as possible under the ground paddle.

## Evaluation Board Schematic

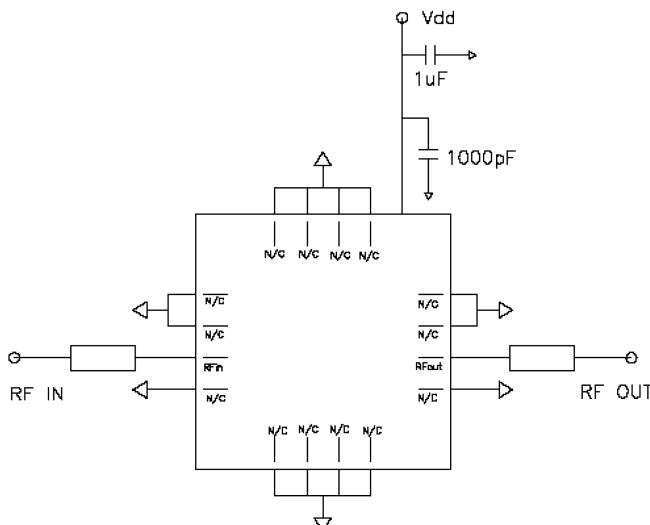

# 5.0-14.0 GHz GaAs MMIC Packaged Driver Amplifier

## Package Outline and Assembly

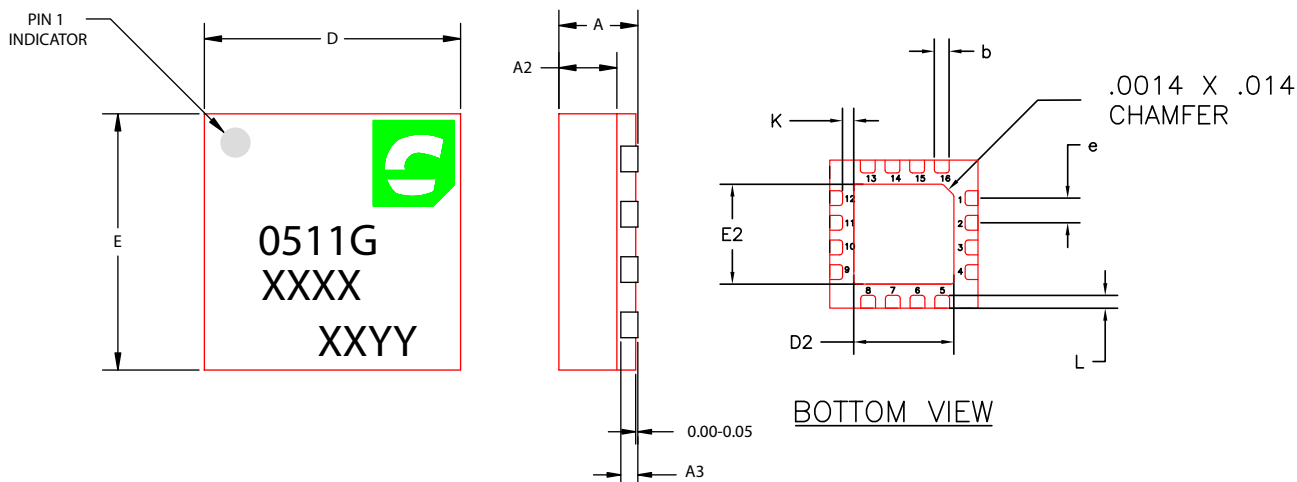

RECOMMENDED SOLDER PAD PITCH AND DIMENSIONS

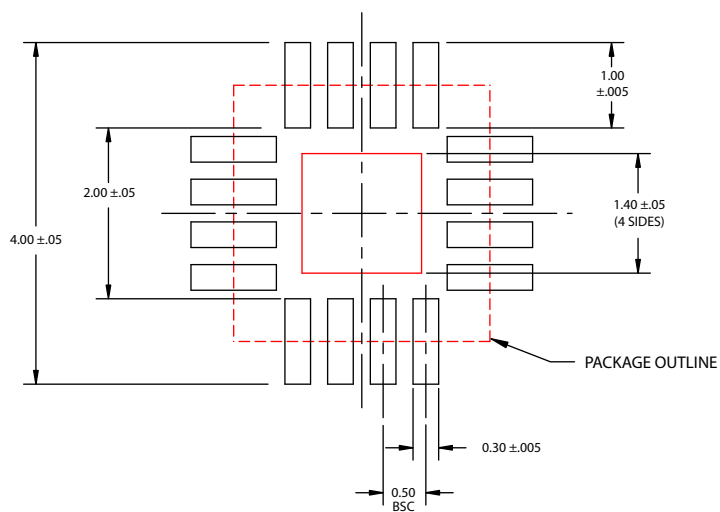

NOTE:

1. ALL DIMENSIONS ARE IN mm

	MIN	NOM	MAX
A	0.80	0.90	1.00
A3		0.20 REF	
A2	0	0.65	1.00
b	0.20	0.25	0.30
K	0.20	-	-
D		3.00 BSC	
E		3.00 BSC	
e		0.50	
D2	1.50	1.65	1.80
E2	1.50	1.65	1.80
L	0.16	0.26	0.36

## Ordering Information

Part Number for Ordering

CMM0511-QT-0G00

CMM0511-QT-0G0T

PB-CMM0511-QT-0000

Description

Matte Tin finished RoHS compliant 3x3 QFN in bulk quantity

Matte Tin finished RoHS compliant 3x3 QFN in tape and reel

Evaluation Board

# 5.0-14.0 GHz GaAs MMIC Packaged Driver Amplifier

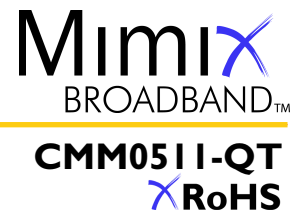

February 2007 - Rev 02-Feb-07

## Handling and Assembly Information

**CAUTION!** - Mimix Broadband MMIC Products contain gallium arsenide (GaAs) which can be hazardous to the human body and the environment. For safety, observe the following procedures:

- Do not ingest.
- Do not alter the form of this product into a gas, powder, or liquid through burning, crushing, or chemical processing as these by-products are dangerous to the human body if inhaled, ingested, or swallowed.
- Observe government laws and company regulations when discarding this product. This product must be discarded in accordance with methods specified by applicable hazardous waste procedures.

**Life Support Policy** - Mimix Broadband's products are not authorized for use as critical components in life support devices or systems without the express written approval of the President and General Counsel of Mimix Broadband. As used herein: (1) Life support devices or systems are devices or systems which, (a) are intended for surgical implant into the body, or (b) support or sustain life, and whose failure to perform when properly used in accordance with instructions for use provided in the labeling, can be reasonably expected to result in a significant injury to the user. (2) A critical component is any component of a life support device or system whose failure to perform can be reasonably expected to cause the failure of the life support device or system, or to affect its safety or effectiveness.

**Package Attachment** - This packaged product from Mimix Broadband is provided as a rugged surface mount package compatible with high volume solder installation. Care should be taken not to apply heavy pressure to the top or base material to avoid package damage. Vacuum tools or other suitable pick and place equipment may be used to pick and place this part. Care should be taken to ensure that there are no voids or gaps in the solder connection so that good RF, DC and ground connections are maintained. Voids or gaps can eventually lead not only to RF performance degradation, but reduced reliability and life of the product due to thermal stress.

**Mimix Lead-Free RoHS Compliant Program** - Mimix has an active program in place to meet customer and governmental requirements for eliminating lead (Pb) and other environmentally hazardous materials from our products. All Mimix RoHS compliant components are form, fit and functional replacements for their non-RoHS equivalents. Lead plating of our RoHS compliant parts is 100% matt tin (Sn) over copper alloy and is backwards compatible with current standard SnPb low-temperature reflow processes as well as higher temperature (260°C reflow) "Pb Free" processes.

**Part Numbering Designator** - For Mimix/Celeritek lead-free products, the letter "G" will be used in the part number for Matte Tin finished RoHS Compliant components and "L" will be used in the part number of NiPdAu finished RoHS Compliant components in the second position of the part number suffix, as shown below:

Example A: CXX1234-XX-0G00 = component bulk quantity Matte Tin finished RoHS compliant parts

Example B: CXX1234-XX-0L0T = component in tape and reel NiPdAu finished RoHS parts

For those customers not making the change at this time, Mimix/Celeritek will maintain production of current configurations. For questions and comments e-mail: [ourearth@mimixbroadband.com](mailto:ourearth@mimixbroadband.com).