



Advanced Product Information
November 2002 (1 of 4)

1.85 to 1.91 GHz
3.0V, 30 dBm, PCS/PCN
LCC-8 Power Amplifier

Features

- ❑ Operation as Low as 3.0V
- ❑ 38% Linear Power Added Efficiency
- ❑ +30 dBm Output Power (IS-136 TDMA Mode)
- ❑ +28.5 dBm Output Power (IS-98 CDMA Mode)
- ❑ 32 dB Gain at Operating Output
- ❑ Tested Under Digital Modulation
- ❑ New Low-Cost, Thermally Enhanced, LCC-8 Package
- ❑ PHEMT Material Technology

Applications

- ❑ PCS Handsets
- ❑ PCS Base Stations
- ❑ Wireless Local Loop Subscriber Units
- ❑ CDMAone Handsets

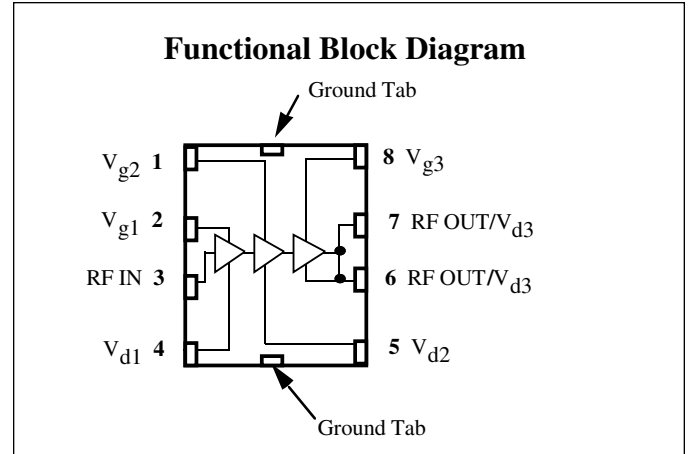

Description

The CMM1530-LC is a linear power amplifier intended for use in PCS handsets and wireless local loop subscriber units. The amplifier can be biased to meet the requirements of PCS-1900, IS-136 (TDMA), IS-98 (CDMA) or DCS-1800 systems. It is a member of Celeritek's new **Triniti DX Pro™** family of 3V power amplifier MMICs.

The CMM1530-LC is packaged in a low-cost, space efficient, LCC-8 package that provides excellent electrical stability and low thermal resistance. The part requires minimal external circuitry for bias and matching to reduce space and cost.

This device is unconditionally stable under all source and load impedances.

Absolute Maximum Ratings

Parameter	Rating	Parameter	Rating	Parameter	Rating
Drain Voltage (+V _d)	+5.5 V*	Power Dissipation	5 W	Operating Temperature	-40°C to +90°C
Drain Current (I _d)	1.8 A	Thermal Resistance	20°C/W	Channel Temperature	150°C
RF Input Power	3 dBm*	Storage Temperature	-65°C to +150°C	Soldering Temperature	260°C for 5 Sec.
DC Gate Voltage (-V _g)	-3.0 V*				

* Max (+V_d) and (-V_g) under linear operation. Max potential difference across the device at 1dB gain compression point (2V_d + |-V_g|) not to exceed the minimum breakdown voltage (V_{br}) of +12V.

Recommended Operating Conditions

Parameter	Typ	Units	Parameter	Typ	Units
Drain Voltage (+V _d)	3.0 to 4.2	Volts	Operating Temperature (PC Board)	-30 to +80	°C

Application Information

The CMM1530-LC is a three stage amplifier that requires a positive and a negative supply voltages for proper operation. It is essential when turning on the device that the negative supply be applied before the positive supply. When turning the device off, the positive supply should be removed before the negative supply is removed.

The CMM1530-LC can be operated over a range of supply voltages and bias points. It is important that the maximum power dissipation of the package be observed at all times and that the maximum voltage across the device is not exceeded.

Circuit Design Considerations

Biasing Negative gate voltages are necessary to set the bias currents of the three FET stages in the CMM1530-LC. The first stage gate bias voltage is applied to Vg1 (Pin 2). The second stage gate bias voltage is applied to Vg2 (Pin 1), while the

third stage FET gate bias is applied to Vg3 (Pin 8). It is desirable to use one or more DACs (digital to analog converters) along with appropriate divider networks, in order to adjust the quiescent currents to within 10 mA of the target values. As an example, for CDMA applications the target quiescent current of the third FET is 85 mA, while those for the second and the first FETs are 45 and 15 mA, respectively. The total quiescent is 135 mA. It is also recommended that the quiescent currents be set in the following sequence: the third stage FET is set first, followed by the second stage FET, followed by the first stage FET. The negative supply voltages control the quiescent currents through each of the FETs and, therefore, control the output power, adjacent channel power ratios, and the currents at the full output power.

The positive supply voltages are applied to Pins 4, 5, 6 and 7.

- Continued on Page 2 -

Electrical Characteristics

Unless otherwise specified, the following specifications are guaranteed at room temperature with drain voltage ($+V_{D}$) = 3.5 V in Celeritek test fixture.

Parameter	Condition	Min	Typ	Max	Units
Frequency Range		1.85		1.91	GHz
Gain	@ Digital power output	28	31		dB
Gain Ripple*	1805-1880 MHz & 1850-1910 MHz			1.5	dB
Gain Variation	Over supply voltage		2		dB/V
	Over temperature		0.03		dB/°C
Power Output Control Range	V _{dd} = 0 V to +3.5 V		50		dB
Power Output	Meets IS-136 TDMA mask		+30.0		dBm
	Meets IS-98 CDMA mask		+28.5		dBm
Harmonics	2nd @ Digital power output, no output trapping, P _o =+28.5 dBm		-30		dBc
	3rd @ Digital power output, no output trapping, P _o =+28.5 dBm		-40		dBc
Noise Power in Receive Band	30 kHz bandwidth		-94		dBm
Linearity	CDMA modulation @ +28.5 dBm P _{out} , 1.25 MHz offset	-45			dBc/30KHz
	TDMA modulation @ +30 dBm P _{out} - Adjacent	-26			dBc
	TDMA modulation @ +30 dBm P _{out} - Alternate	-45			dBc
Spurious Signal	VSWR = 3:1 in-band, VSWR = 10:1 out-of-band			-80	dBc
Noise Figure			3.0		dB
Input Return Loss			10		dB
Output Return Loss			8		dB
Efficiency (V _{dd} = 3.0 V)	P _{out} = +30.0 dBm - TDMA	36	38		%
	P _{out} = +28.5 dBm - CDMA	32	35		%
Positive Supply Current (I _D)	P _{out} IS-136 TDMA		750		mA
	P _{out} IS-98 CDMA		595		mA
Quiescent Current (I _Q)	No RF CDMA mode		130		mA
	No RF TDMA mode		200		mA
Negative Supply Current (-I _G)	Includes external resistor divider		1.1	2.0	mA
Negative Supply Voltage (-V _G)	Into external resistor divider	-0.5	-0.8	-1.4	V

* Specifications guaranteed over the temperature range of -20°C to +80°C

- Continued from Page 1 -

It is very important to provide adequate de-coupling between the RF and DC signals in designing the DC bias circuit. Inadequate by-pass capacitance and inductance around the DC supply lines can compromise the adjacent channel power ratio (ACPR), or reduce power gain and/or create oscillations. The recommend DC by-pass capacitance and low-pass in-line inductance are shown in the evaluation board on Page 4.

Matching Circuits Output matching and input matching circuits are required to achieve the RF specifications in this data sheet. The recommend matching circuits are identical to the matching circuits for the evaluation board shown on Page 4. For output power matching, one shunt capacitor along the transmission line connected to Pins 6 and 7 as well as the bond wire inside the package from the output leads to the output FET are used to transform 50Ω impedance to the load line resistance of the output FET. The placement and the value of the capacitor are important in achieving the performance desired. Matching circuits for the frequencies other than the one shown can be achieved by changing the capacitor value and the placement position of the capacitor. The device can be designed to work from UHF to around 3 GHz.

Supply Ramping To obtain power ramping, gate supply control is recommend. Drain supply voltage ramping can also be used.

Modulation When biased as specified, the CMM1530-LC will achieve the required adjacent channel response for the digital PCS system specified. Celeritek tests each product under digital modulation to ensure correlation to customer applications.

Thermal

1. The copper pad on the backside of the CMM1530-LC must be soldered to the ground plane.
2. All 8 leads of the package must be soldered to the appropriate electrical connection.

Typical Performance

Wideband Gain & Return Loss vs Frequency @ 3.5 V, +25°C

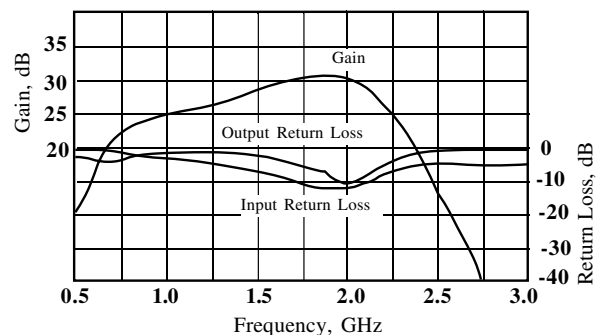



Typical Performance (Continued)

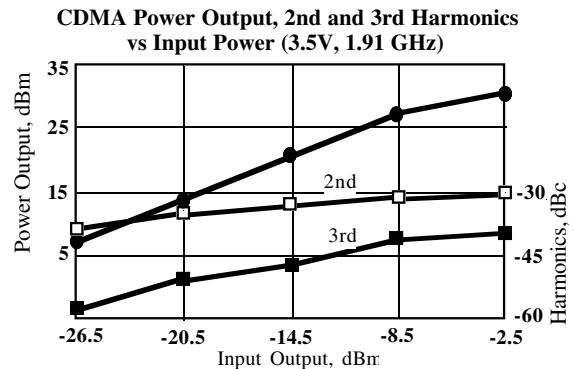
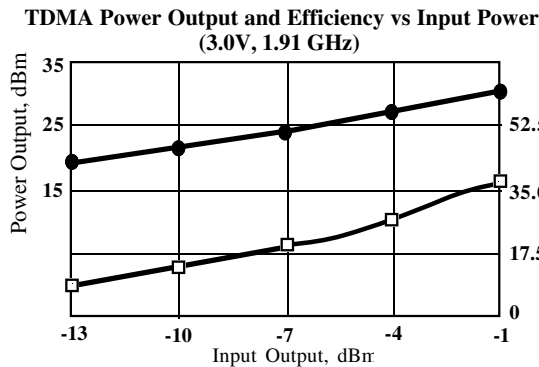
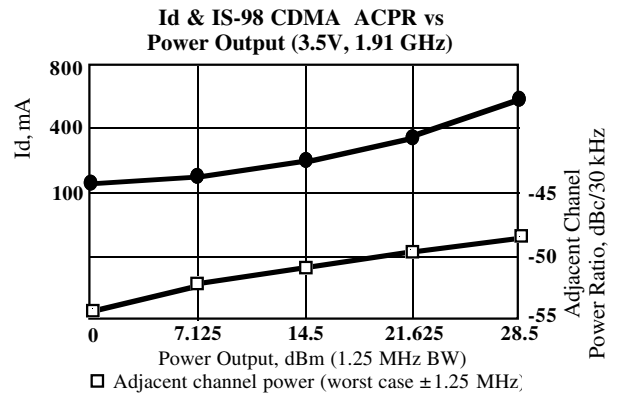
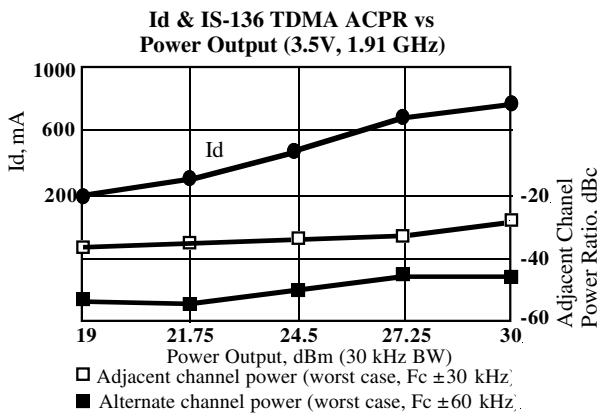
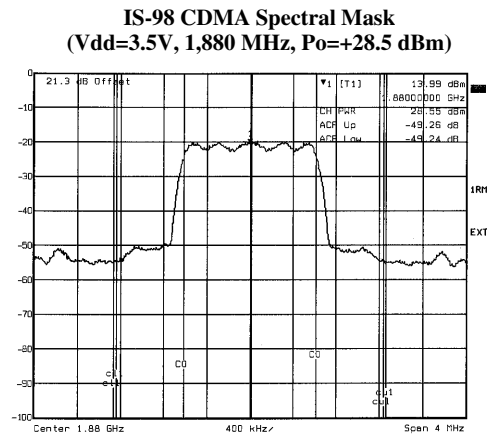
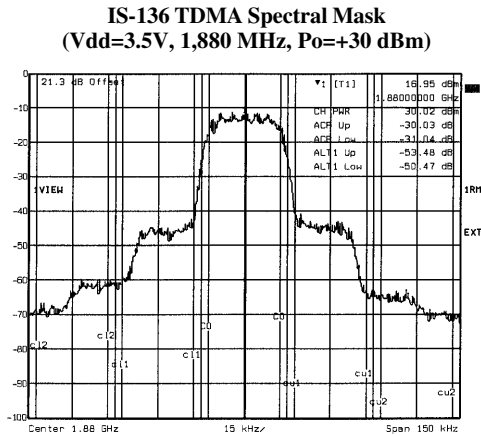
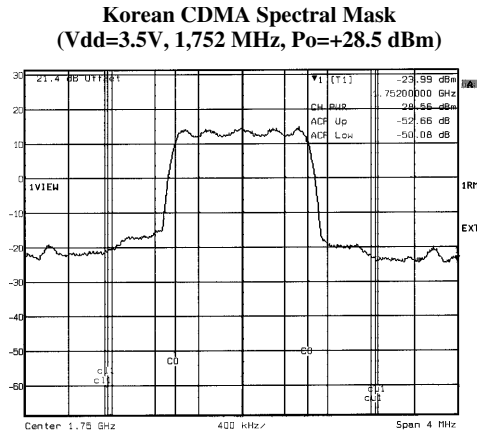
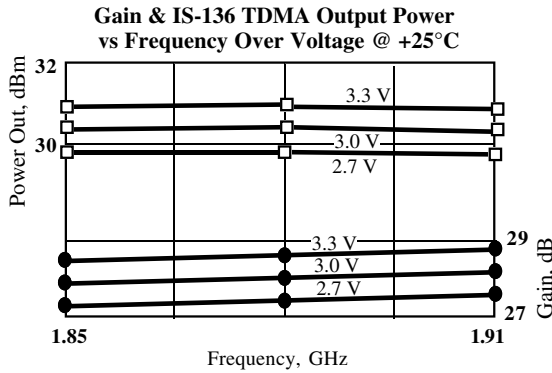

Recommended Matching Topology

Note: This schematic represents the topology of the matching circuit recommended by Celeritek.

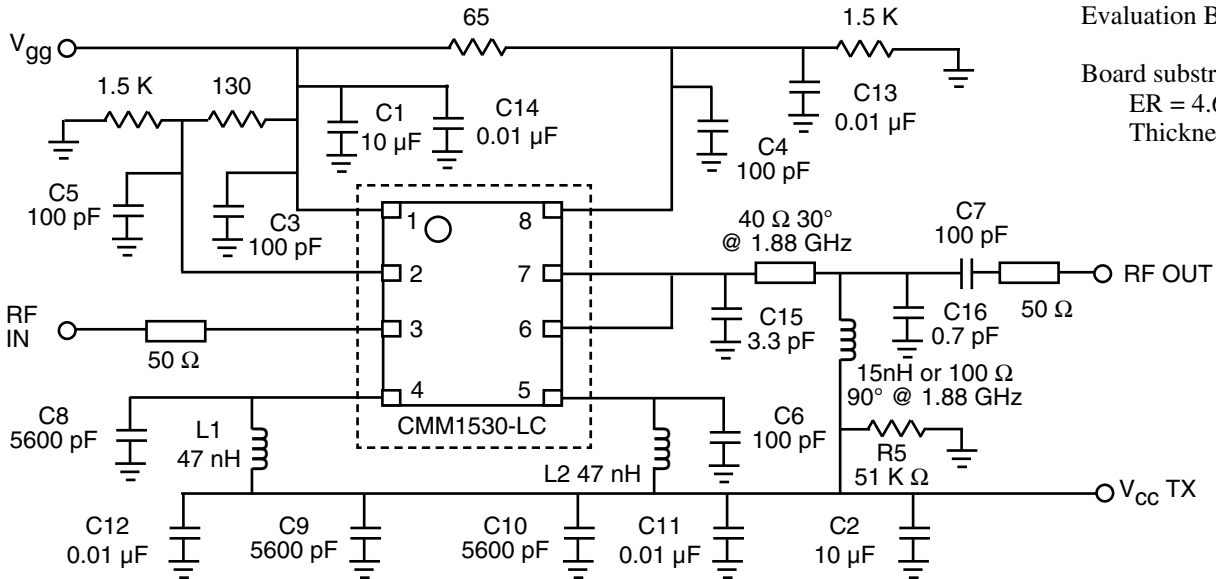

Evaluation Board Schematic

Board substrate:
ER = 4.60
Thickness = 0.031 in.

Physical Dimensions

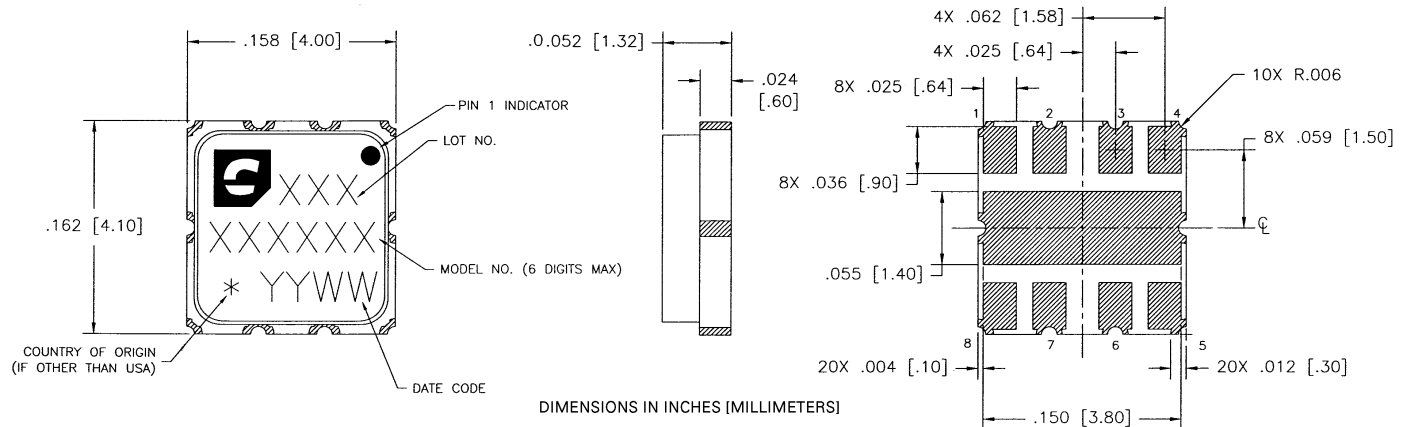

Ordering Information

The CMM1530-LC is available in a surface mount LCC-8 package and devices are available in tube or tape and reel.

Part Number for Ordering

CMM1530-LC-00S0

CMM1530-LC-00T0

CMM1530-LC-00ST

CMM1530-LC-00TT

PB-CMM1530-LC-00S0

PB-CMM1530-LC-00T0

Package

LCC-8 CDMA surface mount power package in tube

LCC-8 TDMA surface mount power package in tube

LCC-8 CDMA surface mount power package in tape and reel

LCC-8 TDMA surface mount power package in tape and reel

Evaluation Board with SMA connectors for CMM1530-LC-00S0 tested CDMA

Evaluation Board with SMA connectors for CMM1530-LC-00T0 tested TDMA

Celeritek reserves the right to make changes without further notice to any products herein. Celeritek makes no warranty, representation or guarantee regarding the suitability of its products for any particular purpose, nor does Celeritek assume any liability arising out of the application or use of any product or circuit, and specifically disclaims any and all liability, including without limitation consequential or incidental damages. "Typical" parameters can and do vary in different applications. All operating parameters, including "Typicals" must be validated for each customer application by customer's technical experts. Celeritek does not convey any license under its patent rights nor the rights of others. Celeritek products are not designed, intended, or authorized for use as components in systems intended for surgical implant into the body, or other applications intended to support or sustain life, or for any other application in which the failure of the Celeritek product could create a situation where personal injury or death may occur. Should Buyer purchase or use Celeritek products for any such unintended or unauthorized application, Buyer shall indemnify and hold Celeritek and its officers, employees, subsidiaries, affiliates, and distributors harmless against all claims, costs, damages, and expenses, and reasonable attorney fees arising out of, directly or indirectly, any claim of personal injury or death associated with such unintended or unauthorized use, even if such claim alleges that Celeritek was negligent regarding the design or manufacture of the part. Celeritek is a registered trademark of Celeritek, Inc. Celeritek, Inc. is an Equal Opportunity/Affirmative Action Employer.