

Ultra-linear Mixer with Integrated IF Amp and LO Buffer

Description

CMY213 is a general purpose down-converter device designed for receiver applications such as cellular and PCS mobile phones, ISM bands, GPS receivers, L-band satellite terminals, WLAN and pagers. It is particularly suited for CDMA receiver applications due to its excellent intermodulation characteristics and its high conversion gain.

The device combines an ultra-linear mixer with LO - driver and a single stage IF-amplifier in a very small SCT598 package. The mixer section of CMY213 combines low conversion losses and excellent intermodulation characteristics with low requirements of LO - and DC-power. The internal level controlled LO-Buffer enables a good performance over a wide LO level range. The input and output matching of the IF amplifier can be adapted externally within a frequency range from 45 to 250 MHz.

Features

- Typical overall performance at cellular frequencies (for $P_{LO} = -5\text{dBm}$ operation conditions: 3V, 8 mA; $f_{RF} = 850\text{ MHz}$; $f_{LO} = 740\text{ MHz}$):
 - Gain: 9.5 dB
 - Input IP3: 10 dBm
 - Noise figure: 8 dB
- RF-frequency range 0.5 - 2.5 GHz
- Operating voltage range: 2.6 to 5V
- Small SCT598 plastic package

Applications

- Down Converter for Multiple Wireless Applications
- Cellular and PCS Mobile Phones
- Particularly Suited for CDMA Receivers
- ISM and WLAN Receivers
- GPS Receivers

Package Outline and Pin Configuration, SCT598

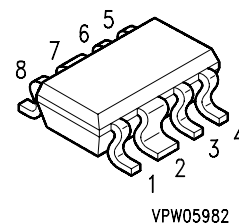
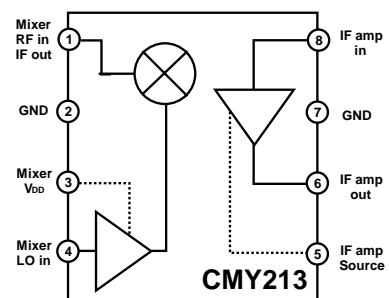

VPW05982

CMY213 Datasheet

Maximum Ratings

Parameter	Port	Symbol	Value		Unit
			min	max	
Supply Voltage	3,6	V_{DD}	0	5	V
DC-Voltage at LO Input	4	V_6	-3	0,5	V
DC-Voltage at Mixer RF-IF Port	1	V_8	- 0,5	+ 0,5	V
Power into Mixer RF Port	1	P_{RF}		10	dBm
Power into LO Input	4	$P_{in,LO}$	-10	10	dBm
Channel Temperature		T_{Ch}		150	°C
Operating Temperature		T_{op}	-30	85	°C
Storage Temperature		T_{stg}	-55	150	°C
Thermal Resistance*					
Channel to Soldering Point (GND)		R_{thChS}		260	K/W

CMY213 Datasheet

Electrical Characteristics

Parameter,	Comment	min	typ	max	Unit
RF - frequency range	external match	0.5	-	2.5	GHz
LO - Frequency range	external match	0.5	-	2.5	GHz
IF Frequency range	external match	45		250	MHz

Typical performance at cellular frequencies*:

$T_a = 25^\circ\text{C}$; $V_{DD} = 3\text{V}$, $f_{RF} = 850\text{MHz}$; $f_{LO} = 740\text{MHz}$; $P_{LO} = -5\text{dBm}$; $f_{IF} = 110\text{MHz}$,
 $Z_S = Z_L = 50\ \Omega$; unless otherwise specified

Parameter, Test Conditions	Symbol	min	typ	max	Unit
Total operating Current (Mixer + IF amplifier)	I_{op}	-	8.0	9.5	mA
Conversion Gain	G_c	8.0	9.5	-	dB
SSB Noise Figure	F_{ssb}	-	8	-	dB
RF Input -/ IF Output return loss (external matching required)	RFIrl / IFOrl	-	10	-	dB
3rd Order Input Intercept Point	IIP3	8	10	-	dBm
LO-RF Isolation	Iso	-	10	-	DB

Test conditions at PCS frequencies:

$T_a = 25^\circ\text{C}$; $V_{DD} = 3\text{V}$, $f_{RF} = 1960\text{MHz}$; $f_{LO} = 1750\text{MHz}$; $P_{LO} = -5\text{dBm}$; $f_{IF} = 210\text{MHz}$,
 $Z_S = Z_L = 50\ \Omega$; unless otherwise specified

Parameter, Test Conditions	Symbol	min	typ	max	Unit
Total operating Current (Mixer + IF amplifier)	I_{op}	-	8.0	9.5	mA
Conversion Gain	G_c	7	8.5	-	dB
SSB Noise Figure	F_{ssb}	-	8.5	-	dB
RF Input -/ IF output return loss (external matching required)	RFIrl / IFOrl	-	10	-	dB
3rd Order Input Intercept Point	IIP3	10	12	-	dBm
LO-RF Isolation	Iso	-	6	-	dB

* IMPORTANT NOTE:

During production, the RF performance at PCS frequencies is screened. The passed devices also achieve the specified RF performance at cellular frequencies.

CMY213 Datasheet

Typical device behavior at cellular frequencies:

$T_a = 25^\circ\text{C}$; $V_{DD} = 3\text{V}$, $f_{RF} = 850\text{MHz}$; $f_{LO} = 740\text{MHz}$; $f_{IF} = 110\text{MHz}$,
 $Z_S = Z_L = 50\ \Omega$; unless otherwise specified

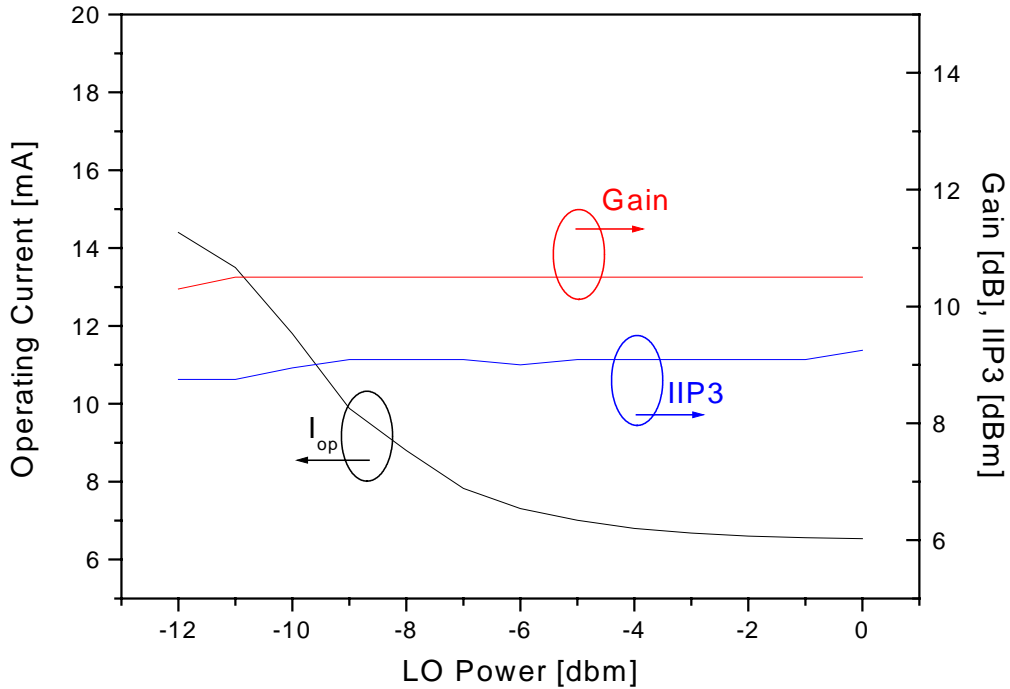

Typical device behavior at PCS frequencies:

$T_a = 25^\circ\text{C}$; $V_{DD} = 3\text{V}$, $f_{RF} = 1960\text{MHz}$; $f_{LO} = 1750\text{MHz}$; $f_{IF} = 210\text{MHz}$,
 $Z_S = Z_L = 50\ \Omega$; unless otherwise specified

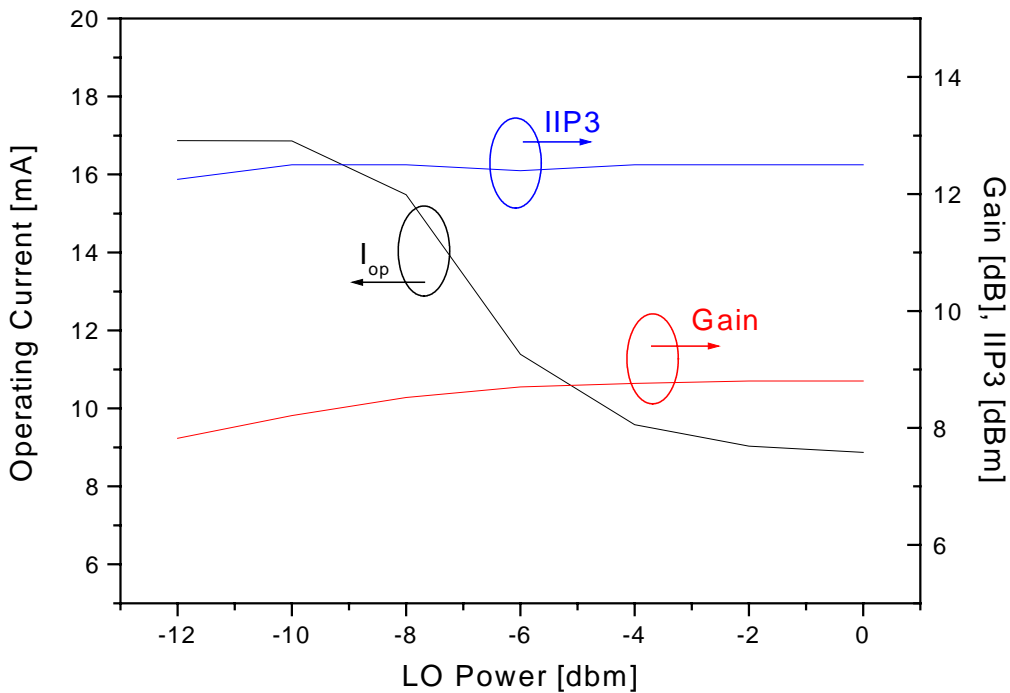

CMY213 Datasheet

Applications Information

Test circuit / application example

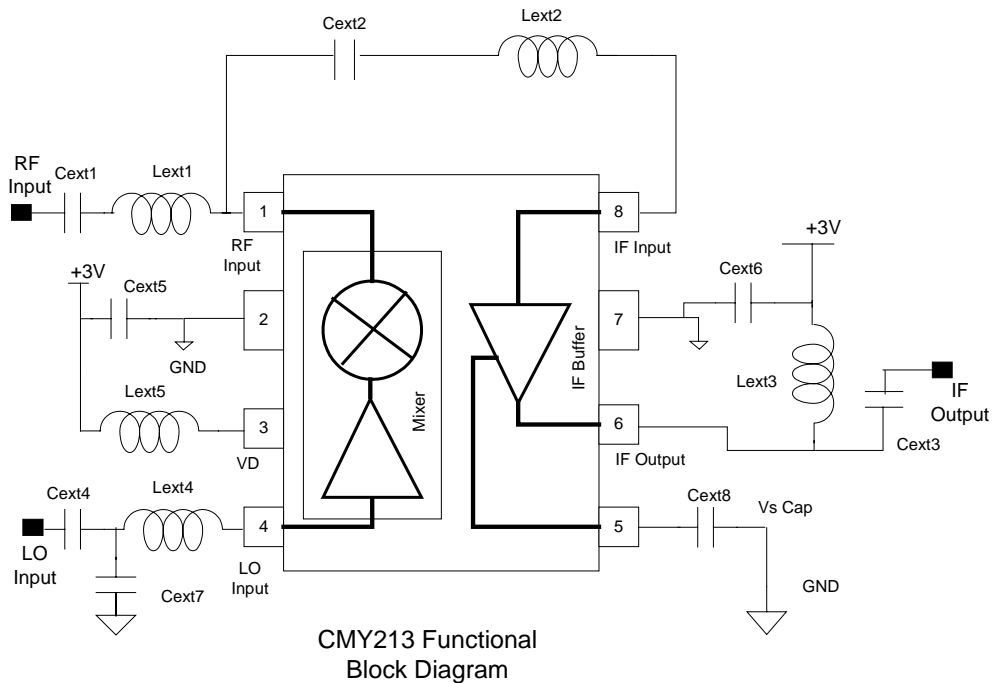

External components for cellular frequencies

$$f_{RF} = 850\text{MHz}; f_{LO} = 740\text{MHz}; f_{IF} = 110\text{MHz}$$

Capacitors	(Murata 0402)	Inductors	(Toko)
Cext1	1.5 pF	Lext1	27 nH LL1005
Cext2	1 nF	Lext2	180 nH LL1608
Cext3	18 pF	Lext3	150 nH LL1608
Cext4	100 pF	Lext4	27 nH LL1005
Cext5	1 nF	Lext5	27 nH LL1005
Cext6	1 nF		
Cext7	3 pF		
Cext8	100 nF		

External components for PCS frequencies

$$f_{RF} = 1960\text{MHz}; f_{LO} = 1750\text{MHz}; f_{IF} = 210\text{MHz}$$

Capacitors	(Murata 0402)	Inductors	(Toko)
Cext1	1 pF	Lext1	5.6 nH LL1005
Cext2	1 nF	Lext2	68 nH LL1608
Cext3	8 pF	Lext3	68 nH LL1608
Cext4	22 pF	Lext4	4.7 nH LL1005
Cext5	1 nF	Lext5	4.7 nH LL1005
Cext6	1 nF		
Cext7	3 pF		
Cext8	100 nF		

CMY213 Datasheet

Applications Information (cont)

PCB-Layout

Size: 35 x 35 mm²

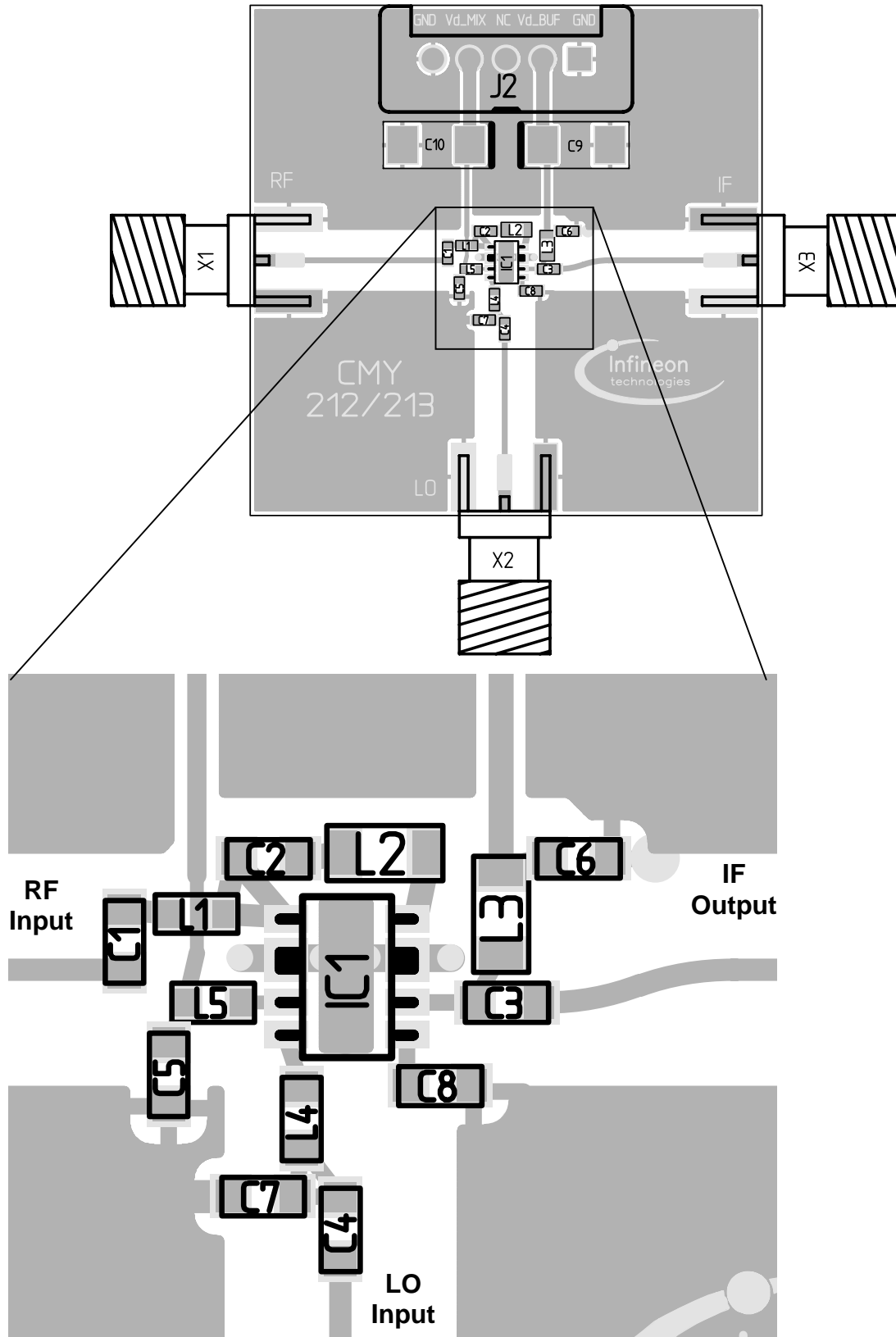

CMY213 Datasheet

General description and notes

CMY213 is a general purpose down-converter device designed for multiple applications such as cellular and PCS mobile phones, ISM bands, GPS receivers, L-band satellite terminals, WLAN and pagers. Due to its excellent intermodulation characteristics and its high conversion gain, CMY213 is particularly suited for CDMA receiver applications.

The device combines an ultra-linear mixer with LO - driver and a single stage IF-amplifier in a very small SCT598 package. The mixer section of CMY213 combines low conversion losses and excellent intermodulation characteristics with low requirements of LO - and DC-power. The internal level controlled LO-Buffer enables a good performance over a wide LO level range. The input and output matching of the IF amplifier can be adapted externally within a frequency range from 45 to 250 MHz.

Semiconductor Device Outline SCT598-8-1

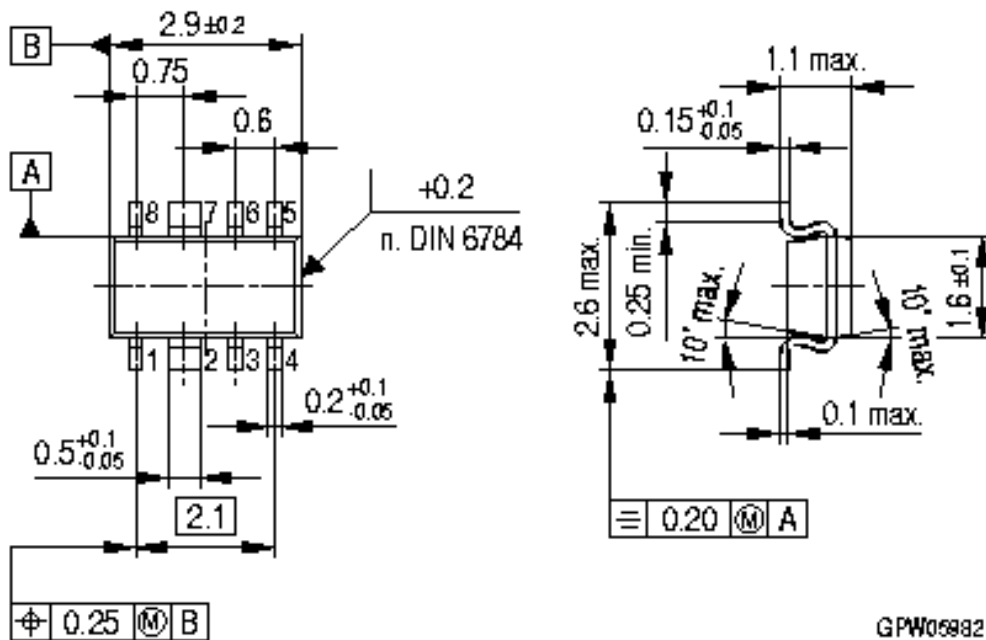

CMY213 Datasheet

Ordering Information

Type	Marking	Ordering code (tape and reel)	Package ¹⁾
CMY213	213	CMY213	SCT598-8-1

Additional Information

This part is compliant with RoHS directive (Restrictions on the Use of Certain Hazardous Substances in Electrical and Electronic Equipment).

The part is rated Moisture Sensitivity Level 1 at 260°C per JEDEC standard IPC/JEDEC J-STD-020.

ESD: **E**lectro**s**tatic **d**ischarge sensitive device. Observe handling Precautions.

For latest specifications, additional product information, worldwide sales and distribution locations, and information about TriQuint:

Web: www.triquint.com **Tel:** (503) 615-9000

Email: info_wireless@tqs.com **Fax:** (503) 615-8902

For technical questions and additional information on specific applications:

Email: info_wireless@tqs.com

The information provided herein is believed to be reliable; TriQuint assumes no liability for inaccuracies or omissions. TriQuint assumes no responsibility for the use of this information, and all such information shall be entirely at the user's own risk. Prices and specifications are subject to change without notice. No patent rights or licenses to any of the circuits described herein are implied or granted to any third party.

TriQuint does not authorize or warrant any TriQuint product for use in life-support devices and/or systems. Copyright © 2005 TriQuint Semiconductor, Inc. All rights reserved.