

**CNY17-1 CNY17-3
CNY17-2 CNY17-4**

PACKAGE DIMENSIONS

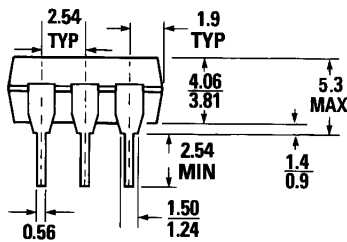
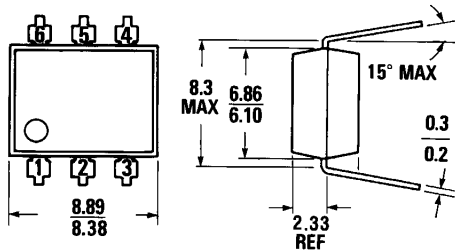

0.40 DIMENSIONS IN mm
PACKAGE CODE K

ST1603A

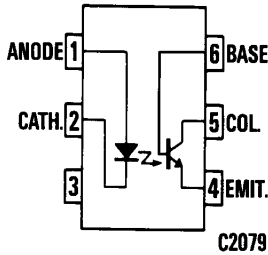

Equivalent Circuit

DESCRIPTION

The CNY17 series consists of a Gallium Arsenide IRED coupled with an NPN phototransistor.

FEATURES

- High isolation voltage
5300 VAC RMS—1 minute
7500 VAC PEAK—1 minute
- High BV_{CEO} minimum 70 volts
- Current transfer ratio in selected groups:
CNY17-1: 40%- 80%
CNY17-2: 63%-125%
CNY17-3: 100%-200%
CNY17-4: 160%-320%
- Maximum switching time in saturation specified
- Underwriters Laboratory (UL) recognized File #E90700

APPLICATIONS

- Power supply regulators
- Digital logic inputs
- Microprocessor inputs
- Appliance sensor systems
- Industrial controls

ABSOLUTE MAXIMUM RATINGS

TOTAL PACKAGE

Storage temperature	−55°C to 150°C
Operating temperature	−55°C to 100°C
Lead temperature (soldering, 10 sec)	260°C
Total package power dissipation @ 25°C (LED plus detector)	260 mW
Derate linearly from 25°C	3.5 mW/°C

INPUT DIODE

Forward DC current	90 mA
Reverse voltage	6 V
Peak forward current (1 μ s pulse, 300 pps)	3.0 A
Power dissipation 25°C ambient	135 mW
Derate linearly from 25°C	1.8 mW/°C

OUTPUT TRANSISTOR

Power dissipation @ 25°C	200 mW
Derate linearly from 25°C	2.67 mW/°C



PHOTOTRANSISTOR OPTOCOUPERS

ELECTRO-OPTICAL CHARACTERISTICS (25°C Temperature Unless Otherwise Specified)

INDIVIDUAL COMPONENT CHARACTERISTICS						
CHARACTERISTIC	SYMBOL	MIN.	TYP.	MAX.	UNITS	TEST CONDITIONS
INPUT DIODE						
Forward voltage	V_f		1.3	1.50	V	$I_f=60\text{ mA}$
Forward voltage temp. coefficient	$\frac{\Delta V_f}{\Delta T_A}$		-1.8		mV/°C	
Reverse voltage	V_R	6.0	15		V	$I_R=10\ \mu\text{A}$
Junction capacitance	C_j		50		pF	$V_f=0\text{ V}, f=1\text{ MHz}$
			65		pF	$V_f=1\text{ V}, f=1\text{ MHz}$
Reverse leakage current	I_R		.35	10	μA	$V_R=3.0\text{ V}$
OUTPUT TRANSISTOR						
DC forward current gain	h_{FE}	100	500			$V_{CE}=5\text{ V}, I_C=100\ \mu\text{A}$
Breakdown voltage						
Collector to emitter	BV_{CEO}	70			V	$I_C=1.0\text{ mA}, I_F=0$
Collector to base	BV_{CBO}	70			V	$I_C=10\ \mu\text{A}, I_F=0$
Emitter to collector	BV_{ECO}	7			V	$I_E=100\ \mu\text{A}, I_F=0$
Leakage current						
Collector to emitter	I_{CEO}		5	50	nA	$V_{CE}=10\text{ V}, I_F=0$
Collector to base	I_{CBO}			20	nA	$V_{CB}=10\text{ V}, I_F=0$
Capacitance						
Collector to emitter			8		pF	$V_{CE}=0, f=1\text{ MHz}$
Collector to base			20		pF	$V_{CB}=5, f=1\text{ MHz}$
Emitter to base			10		pF	$V_{EB}=0, f=1\text{ MHz}$

TRANSFER CHARACTERISTICS						
DC CHARACTERISTICS	SYMBOL	MIN.	TYP.	MAX.	UNITS	TEST CONDITIONS
Current Transfer Ratio, collector to emitter	CTR					$I_F=10\text{ mA}; V_{CE}=5\text{ V}$
		CNY17-1	40		80	
		CNY17-2	63		125	
		CNY17-3	100		200	
		CNY17-4	160		320	
Saturation voltage	$V_{CE(SAT)}$		0.27	.40	V	$I_F=10\text{ mA}; I_C=2.5\text{ mA}$

TRANSFER CHARACTERISTICS						
AC CHARACTERISTICS	SYMBOL	MIN.	TYP.	MAX.	UNITS	TEST CONDITIONS
SWITCHING TIMES						
Non-saturated						
Turn-on time	t_{on}		6.0	10	μs	$R_L=100\ \Omega; I_C=2\text{ mA}; V_{CC}=10\text{ V}$
Turn-off time	t_{off}		5.5	10	μs	See Fig. 10 and Fig. 11.

ELECTRO-OPTICAL CHARACTERISTICS (25°C Temperature Unless Otherwise Specified) (Cont'd)

TRANSFER CHARACTERISTICS (Cont'd)

AC CHARACTERISTICS	SYMBOL	MIN.	TYP.	MAX.	UNITS	TEST CONDITIONS
SATURATED SWITCHING TIMES						
Turn-on time	t_{on}					
CNY17-1			3.0	5.5	μs	$I_F = 20 \text{ mA}, V_{CE} = 0.4 \text{ V}$
CNY17-2, CNY17-3, CNY17-4			4.2	8.0	μs	$I_F = 10 \text{ mA}, V_{CE} = 0.4 \text{ V}$
Rise-time	t_r					
CNY17-1			2.0	4.0	μs	$I_F = 20 \text{ mA}, V_{CE} = 0.4 \text{ V}$
CNY17-2, CNY17-3, CNY17-4			3.0	6.0	μs	$I_F = 10 \text{ mA}, V_{CE} = 0.4 \text{ V}$
Turn-off time	t_{off}					
CNY17-1			18	34	μs	$I_F = 20 \text{ mA}, V_{CE} = 0.4 \text{ V}$
CNY17-2, CNY17-3, CNY17-4			23	39	μs	$I_F = 10 \text{ mA}, V_{CE} = 0.4 \text{ V}$
Fall-time	t_f					
CNY17-1			11	20	μs	$I_F = 20 \text{ mA}, V_{CE} = 0.4 \text{ V}$
CNY17-2, CNY17-3, CNY17-4			14	24	μs	$I_F = 10 \text{ mA}, V_{CE} = 0.4 \text{ V}$

ISOLATION CHARACTERISTICS

CHARACTERISTICS	SYMBOL	MIN.	TYP.	MAX.	UNITS	TEST CONDITIONS
Isolation Voltage	V_{iso}	5300			$V_{AC} \text{ RMS}$	$I_{i,o} \leq 1 \mu\text{A}, 1 \text{ minute}$
	V_{iso}	7500			$V_{AC} \text{ PEAK}$	$I_{i,o} \leq 1 \mu\text{A}, 1 \text{ minute}$
Isolation resistance	R_{iso}	10^{11}			ohms	$V_{i,o} = 500 \text{ VDC}$
Isolation capacitance	C_{iso}		0.5		pF	$f = 1 \text{ MHz}$

ELECTRICAL CHARACTERISTIC CURVES (25°C Free Air Temperature Unless Otherwise Specified)

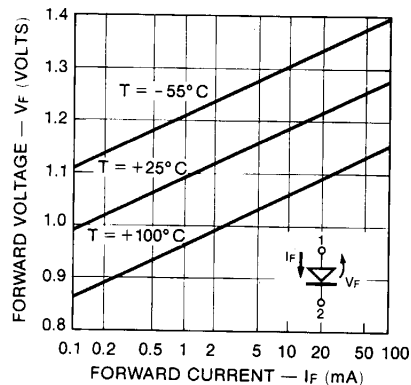

Fig. 1. Forward Voltage vs. Current

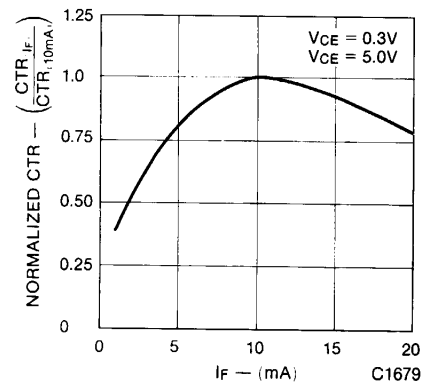

Fig. 2. Normalized CTR vs. Forward Current

ELECTRICAL CHARACTERISTIC CURVES

(25°C Free Air Temperature Unless Otherwise Specified) (Cont'd)

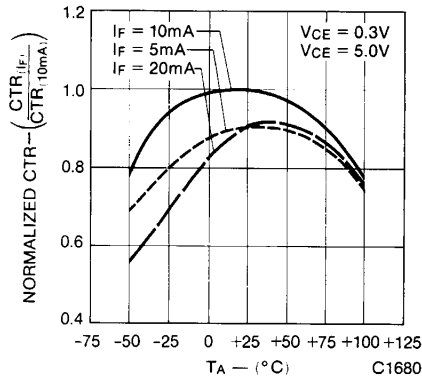

Fig. 3. Normalized CTR vs. Temperature

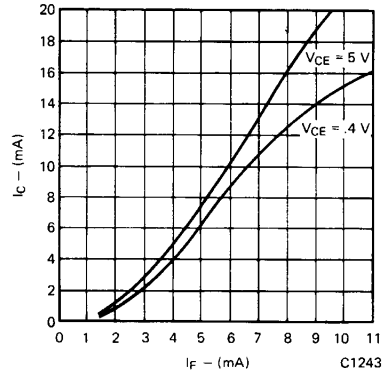

Fig. 4. Collector Current vs. Forward Current

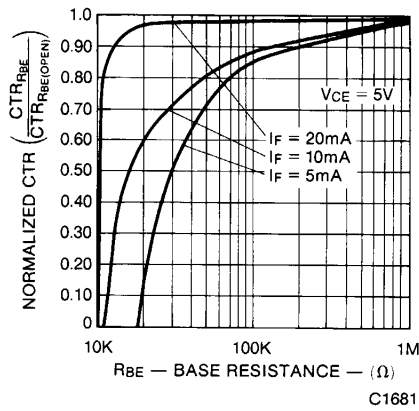

Fig. 5. CTR vs. R_{BE} (Unsaturated)

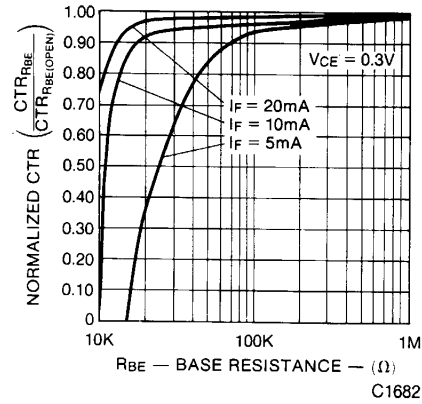

Fig. 6. CTR vs. R_{BE} (Saturated)

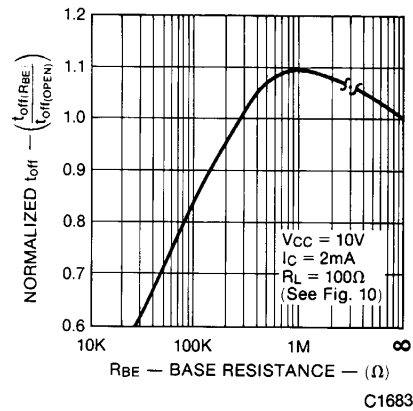

Fig. 7. Normalized T_{off} vs. R_{BE}

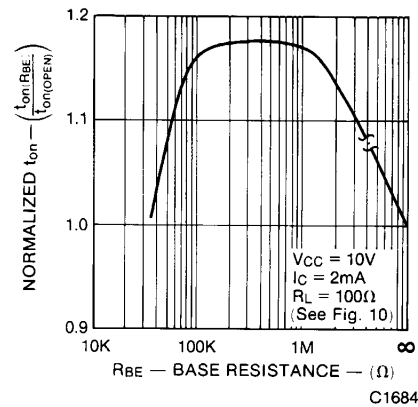

Fig. 8. Normalized T_{on} vs. R_{BE}

ELECTRICAL CHARACTERISTIC CURVES
(25°C Free Air Temperature Unless Otherwise Specified) (Cont'd)

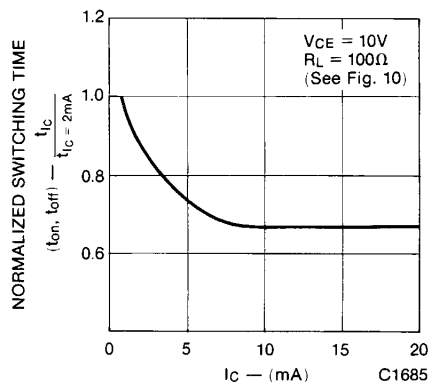

Fig. 9. Switching Time vs. IC

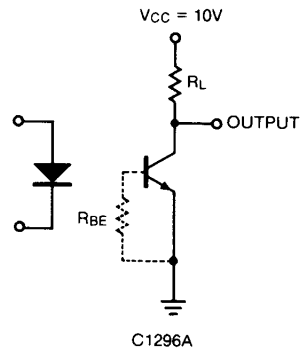

Fig. 10. Switching Time Test Circuit

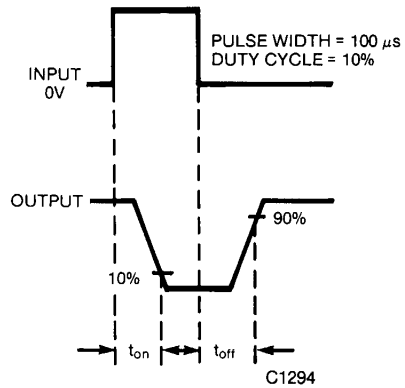

Fig. 11. Switching Time Waveforms