

TOSHIBA Photocoupler GaAs Ired & Photo-Transistor

CNY17-2,CNY17-3,CNY17-4

- AC Line / Digital Logic Isolator
- Digital Logic / Digital Logic Isolator
- Telephone Line Receiver
- Twisted Pair Line Receiver
- High Frequency Power Supply Feedback Control
- Relay Contact Monitor

The TOSHIBA Corporation CNY17 consist of a gallium arsenide infrared emitting diode coupled with a silicon photo transistor in a dual in-line package.

- Small package size and low cost
- Fast switching speeds: 5µs (typ.)
- High DC current transfer ratio: CTR(I_F = 10mA, V_{CE} = 5V)
 - CNY17-2: 63~125%
 - CNY17-3: 100~200%
 - CNY17-4: 160~320%
- High isolation resistance: 10¹¹Ω (typ.)
- High isolation voltage: 4400V (min.)

Unit in mm

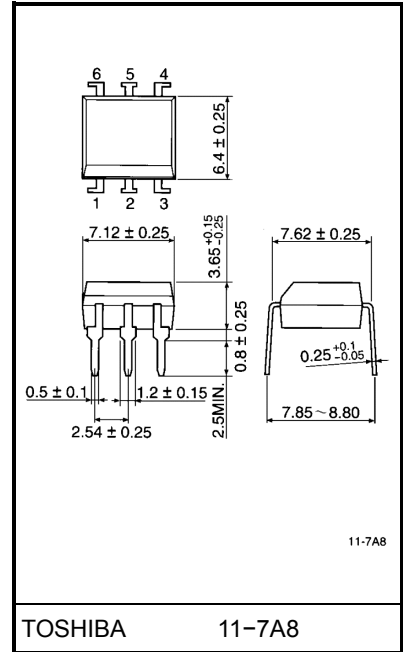

Weight: 0.4 g

Pin Configuration

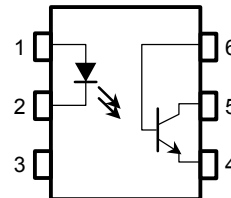

- 1 : Anode
- 2 : Cathode
- 3 : N.C.
- 4 : Emitter
- 5 : Collector
- 6 : Base

Maximum Ratings (Ta = 25°C)

Characteristic		Symbol	Rating	Unit
LED	Forward current	I_F	60	mA
	Forward current derating	$\Delta I_F / ^\circ\text{C}$	0.8 *	mA / °C
	Peak forward current (Note)	I_{PF}	3	A
	Power dissipation	P_D	100	mW
	Power dissipation derating	$\Delta P_D / ^\circ\text{C}$	1.33 *	mW / °C
	Reverse voltage	V_R	6	V
Photo-transistor	Collector-emitter voltage	BV_{CEO}	70	V
	Collector-base voltage	BV_{CBO}	70	V
	Emitter-collector voltage	BV_{ECO}	7	V
	Collector current	I_C	100	mA
	Power dissipation	P_C	150	mW
	Power dissipation derating	$\Delta P_C / ^\circ\text{C}$	2.0 *	mW / °C
Coupled	Storage temperature	T_{stg}	-55~150	°C
	Operating temperature	T_{opr}	-55~100	°C
	Lead soldering temperature (10 s)	T_{sol}	260	°C
	Total package dissipation	P_T	200	mW
	Total package power dissipation derating	$\Delta P_T / ^\circ\text{C}$	2.6 *	mW / °C

(Note)Pulse width 1μs, 300pps.

* Above 25°C ambient.

Electrical Characteristics (Ta = 25°C)

Characteristic		Symbol	Test Condition	Min.	Typ.	Max.	Unit	
LED	Forward voltage	V_F	$I_F = 60 \text{ mA}$	—	1.35	1.65	V	
	Reverse current	I_R	$V_R = 3 \text{ V}$	—	—	10	μA	
	Capacitance	C_D	$V = 0, f = 1 \text{ MHz}$	—	30	—	pF	
Photo-transistor	DC forward current gain	h_{FE}	$V_{CE} = 5, I_C = 500 \mu\text{A}$	100	200	—		
	Collector-emitter breakdown voltage	$V_{(BR)CEO}$	$I_C = 1 \text{ mA}, I_F = 0$	70	—	—	V	
	Collector-base breakdown voltage	$V_{(BR)CBO}$	$I_C = 100 \mu\text{A}, I_F = 0$	70	—	—	V	
	Emitter-collector breakdown voltage	$V_{(BR)ECO}$	$I_E = 100 \mu\text{A}, I_F = 0$	7	—	—	V	
	Collector dark current	I_{CEO}	$V_{CE} = 10 \text{ V}, I_F = 0$	—	1	50	nA	
	Collector dark current	I_{CBO}	$V_{CB} = 10 \text{ V}, I_F = 0$	—	0.1	20	nA	
	Collector-emitter capacitance	C_{CE}	$V = 0, f = 1 \text{ MHz}$	—	10	—	pF	
Coupled	Current transfer ratio	CNY17-2	$I_F = 10 \text{ mA}, V_{CE} = 5 \text{ V}$	CTR	63	—	125	%
		CNY17-3			100	—	200	
		CNY17-4			160	—	320	
	Saturation voltage	$V_{CE(sat)}$	$I_F = 10 \text{ mA}, I_C = 2.5 \text{ mA}$	—	—	0.4	V	
	Capacitance input to output	C_S	$V = 0, f = 1 \text{ MHz}$	—	0.8	—	pF	
	Isolation resistance	R_S	$V = 500 \text{ V}$	—	10^{11}	—	Ω	
	DC isolation voltage	BV_S	DC 1 minute	4400	—	—	V	
Rise fall time	t_r / t_f	$V_{CE} = 10 \text{ V}, I_C = 2 \text{ mA}$ $R_L = 100 \Omega$	—	5	10	μs		
Rise / fall time photo diode	t_r / t_f	$V_{CB} = 10 \text{ V}, I_{CB} = 50 \mu\text{A}$ $R_L = 100\Omega$	—	200	—	ns		

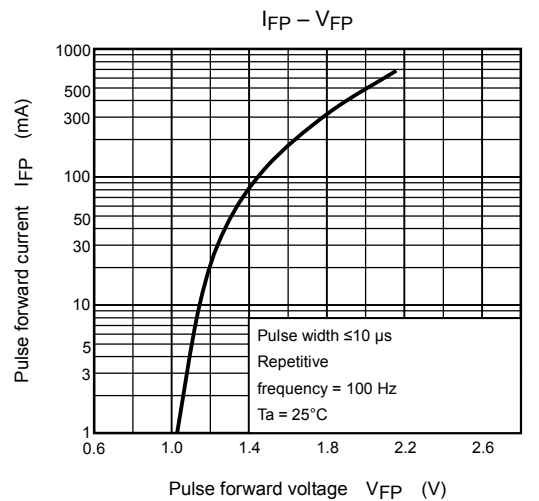
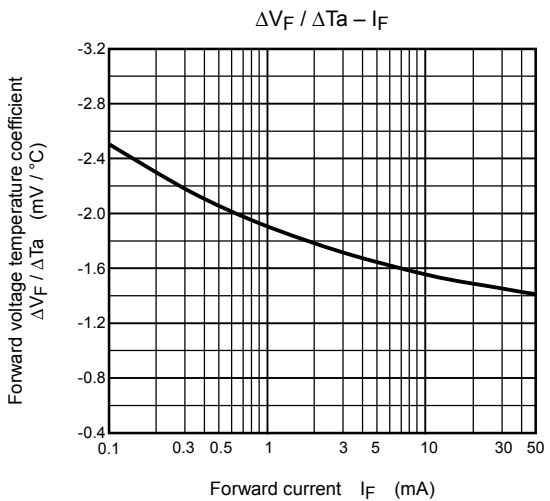
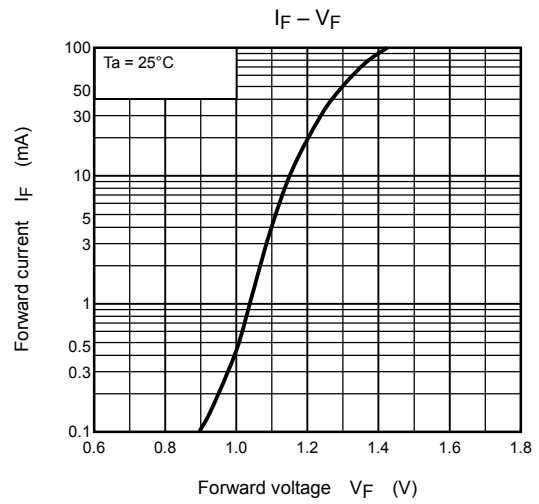
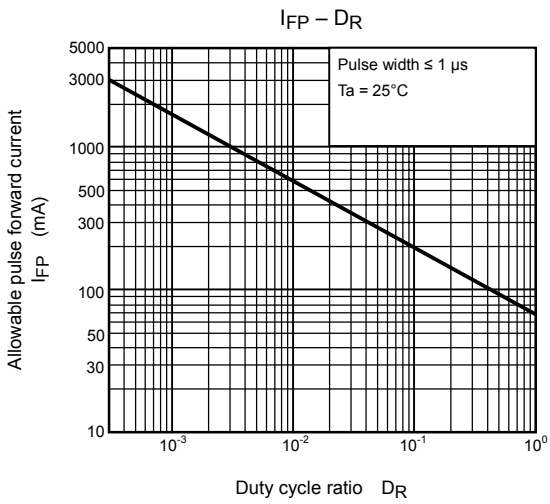
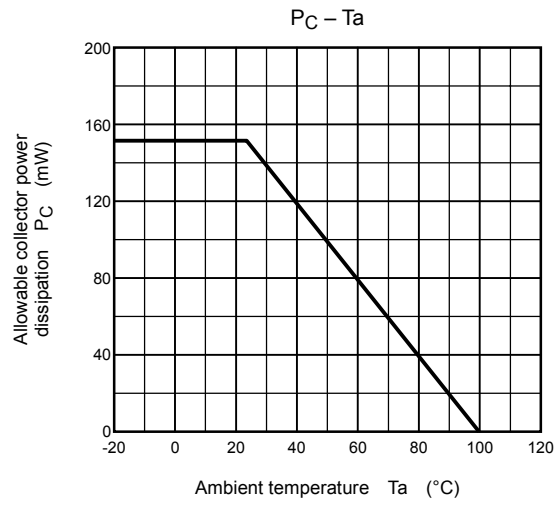
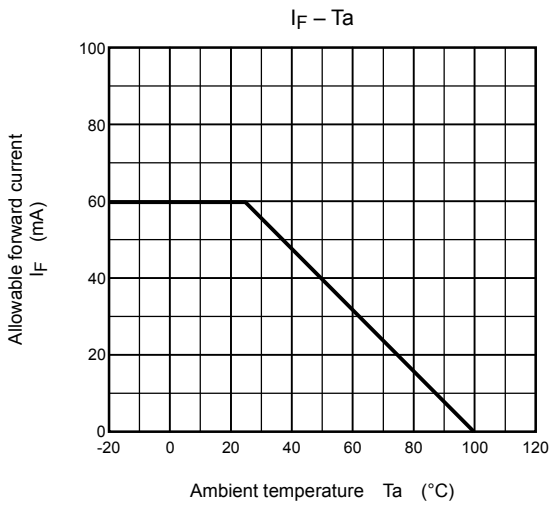

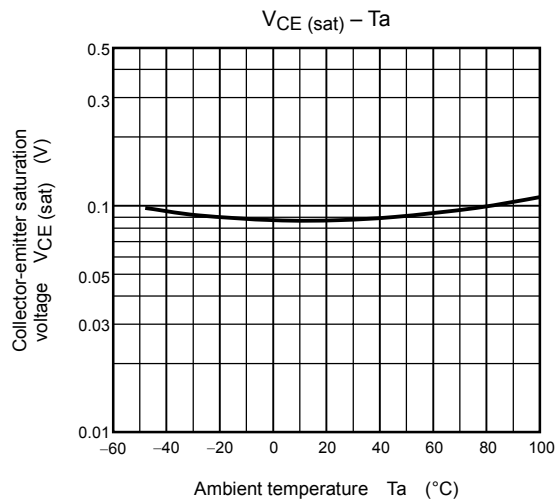
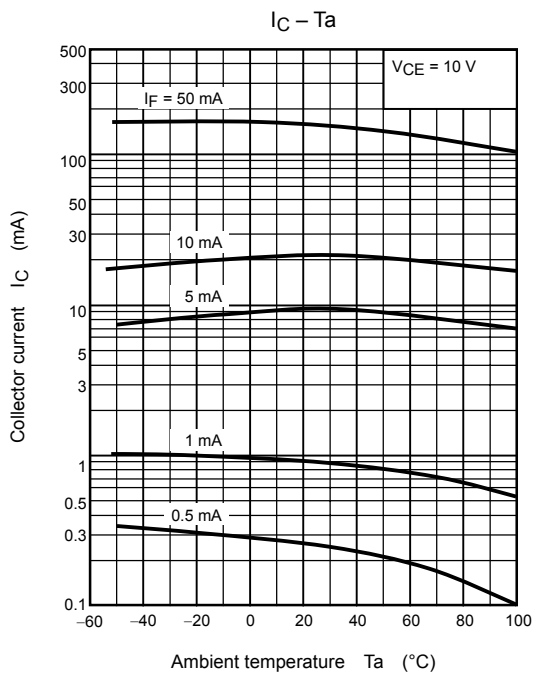
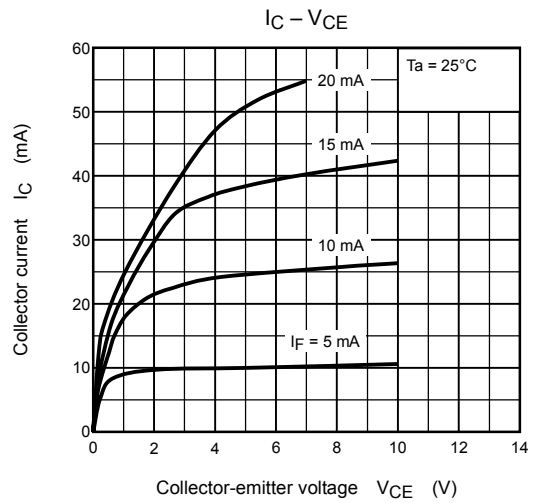
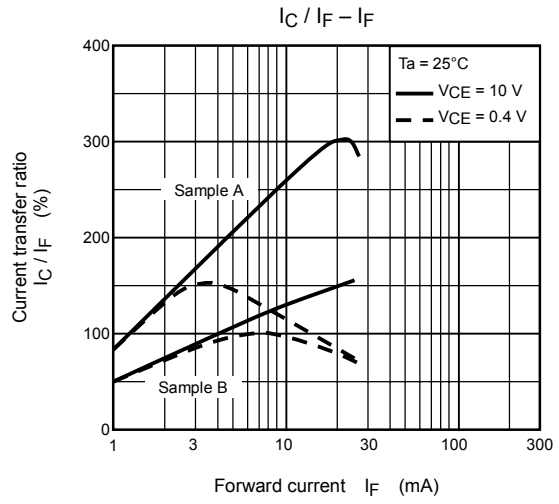
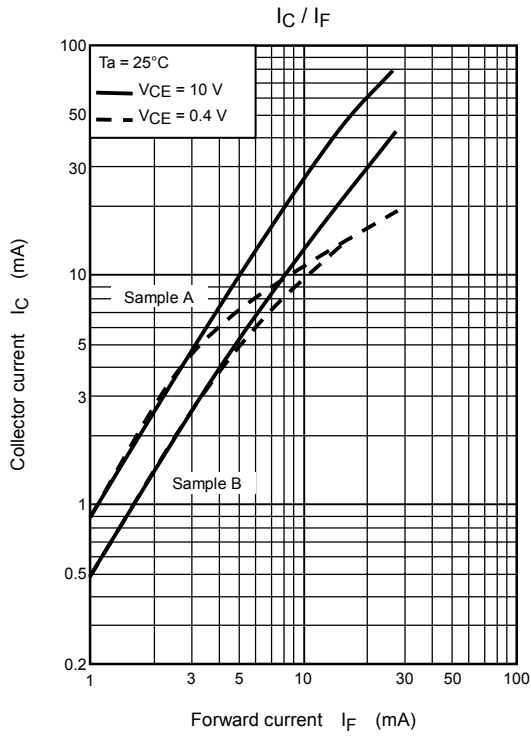

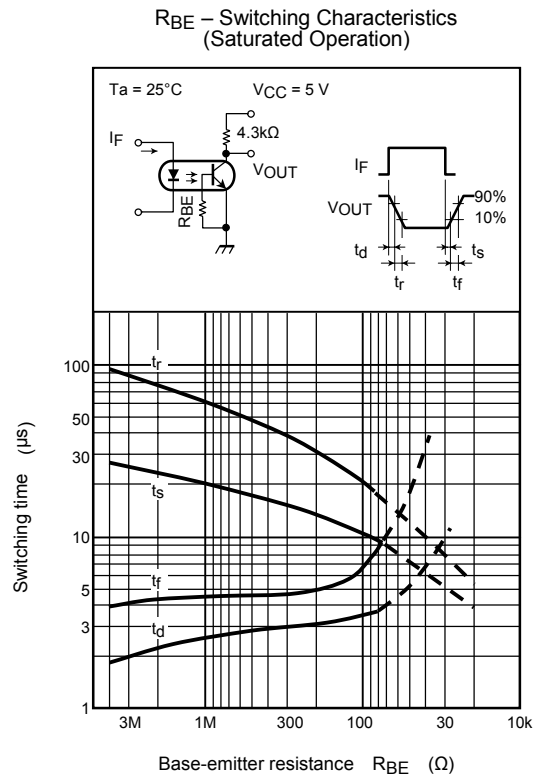
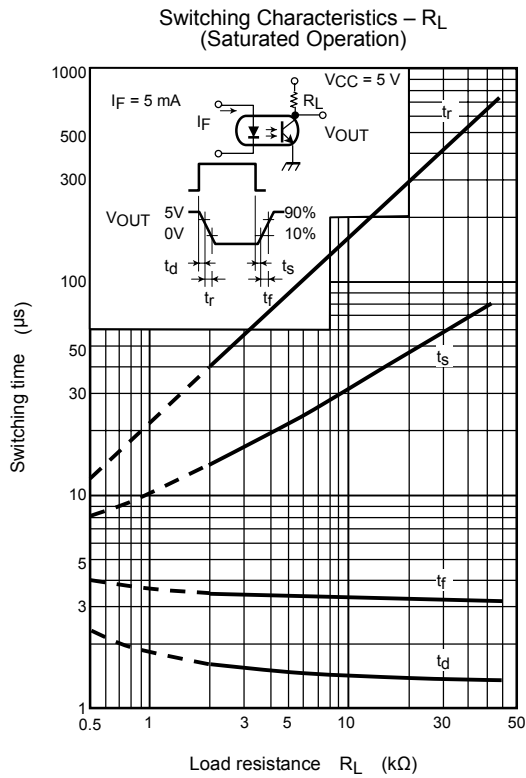
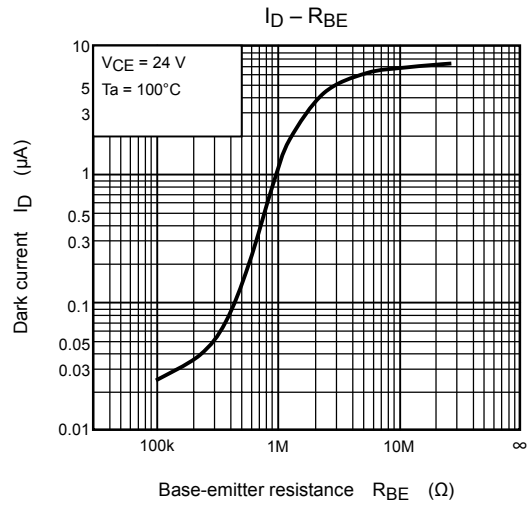
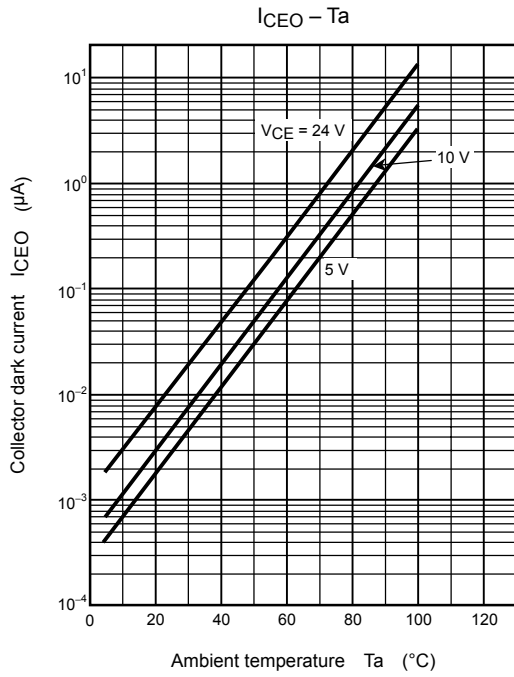

RESTRICTIONS ON PRODUCT USE

000707EBC

- TOSHIBA is continually working to improve the quality and reliability of its products. Nevertheless, semiconductor devices in general can malfunction or fail due to their inherent electrical sensitivity and vulnerability to physical stress. It is the responsibility of the buyer, when utilizing TOSHIBA products, to comply with the standards of safety in making a safe design for the entire system, and to avoid situations in which a malfunction or failure of such TOSHIBA products could cause loss of human life, bodily injury or damage to property.
In developing your designs, please ensure that TOSHIBA products are used within specified operating ranges as set forth in the most recent TOSHIBA products specifications. Also, please keep in mind the precautions and conditions set forth in the "Handling Guide for Semiconductor Devices," or "TOSHIBA Semiconductor Reliability Handbook" etc..
- The TOSHIBA products listed in this document are intended for usage in general electronics applications (computer, personal equipment, office equipment, measuring equipment, industrial robotics, domestic appliances, etc.). These TOSHIBA products are neither intended nor warranted for usage in equipment that requires extraordinarily high quality and/or reliability or a malfunction or failure of which may cause loss of human life or bodily injury ("Unintended Usage"). Unintended Usage include atomic energy control instruments, airplane or spaceship instruments, transportation instruments, traffic signal instruments, combustion control instruments, medical instruments, all types of safety devices, etc.. Unintended Usage of TOSHIBA products listed in this document shall be made at the customer's own risk.
- Gallium arsenide (GaAs) is a substance used in the products described in this document. GaAs dust and fumes are toxic. Do not break, cut or pulverize the product, or use chemicals to dissolve them. When disposing of the products, follow the appropriate regulations. Do not dispose of the products with other industrial waste or with domestic garbage.
- The products described in this document are subject to the foreign exchange and foreign trade laws.
- The information contained herein is presented only as a guide for the applications of our products. No responsibility is assumed by TOSHIBA CORPORATION for any infringements of intellectual property or other rights of the third parties which may result from its use. No license is granted by implication or otherwise under any intellectual property or other rights of TOSHIBA CORPORATION or others.
- The information contained herein is subject to change without notice.

This datasheet has been download from:

www.datasheetcatalog.com

Datasheets for electronics components.