



Parameter	Rating	Units
Blocking Voltage	600	V_P
Load Current	90	mA_{rms} / mA_{DC}
On-Resistance (max)	50	Ω

Features

- 5000V_{rms} Input/Output Isolation
- 600V_P Blocking Voltage
- 100% Solid State
- Low Drive Power Requirements
- Arc-Free With No Snubbing Circuits
- No EMI/RFI Generation
- Small 4-Pin Package

Applications

- Instrumentation
 - Multiplexers
 - Data Acquisition
 - Electronic Switching
 - I/O Subsystems
- Meters (Watt-Hour, Water, Gas)
- Medical Equipment—Patient/Equipment Isolation
- Security
- Aerospace
- Industrial Controls

Description

The CPC1393G is a single-pole, normally open (1-Form-A) Solid State Relay with an enhanced input to output isolation barrier of 5000V_{rms}.

The relay output is constructed with efficient MOSFET switches that use IXYS Integrated Circuits Division's patented OptoMOS architecture. The input, a highly efficient infrared LED, controls the optically coupled output.

Approvals

- UL Certified Component: File E76270
- CSA Certified Component: Certificate 1172007
- EN/IEC 60950-1 Certified Component:
TUV Certificate B 13 12 82667 003

Ordering Information

Part Number	Description
CPC1393G	4-Pin DIP (100/Tube)
CPC1393GV	4-Pin DIP V-Bend (100/Tube)
CPC1393GR	4-Pin Surface Mount (100/Tube)
CPC1393GRTR	4-Pin Surface Mount (1000/Reel)

Pin Configuration

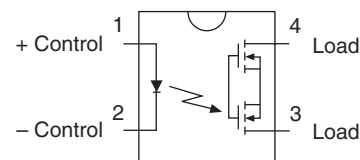

Switching Characteristics of Normally Open Devices

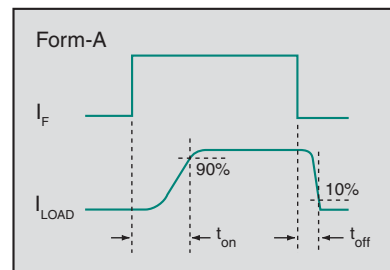

Absolute Maximum Ratings @ 25°C

Parameter	Ratings	Units
Peak Blocking Voltage	600	V _P
Reverse Input Voltage	5	V
Input Control Current	50	mA
Peak (10ms)	1	A
Input Power Dissipation ¹	100	mW
Total Package Dissipation ²	550	mW
Isolation Voltage, Input to Output	5000	V _{rms}
Operational Temperature	-40 to +85	°C
Storage Temperature	-40 to +125	°C

¹ Derate linearly 1.33mW / °C

² Derate linearly 3mW / °C

Absolute Maximum Ratings are stress ratings. Stresses in excess of these ratings can cause permanent damage to the device. Functional operation of the device at conditions beyond those indicated in the operational sections of this data sheet is not implied.

Typical values are characteristic of the device at +25°C, and are the result of engineering evaluations. They are provided for information purposes only, and are not part of the manufacturing testing requirements.

Electrical Characteristics @ 25°C

Parameters	Conditions	Symbol	Min	Typ	Max	Units
Output Characteristics						
Load Current						
Continuous	-	I _L	-	-	90	mA _{rms} / mA _{DC}
Peak	t=10ms	I _{LPK}	-	-	±350	mA _P
On-Resistance ¹	I _L =90mA	R _{ON}	-	35	50	Ω
Off-State Leakage Current	V _L =600V _P	I _{LEAK}	-	-	1	μA
Switching Speeds						
Turn-On	I _F =5mA, V _L =10V (See Timing Diagram)	t _{on}	-	-	5	ms
Turn-Off		t _{off}	-	-	5	
Output Capacitance	I _F =0mA, V _L =50V, f=1MHz	C _{OUT}	-	50	-	pF
Input Characteristics						
Input Control Current to Activate	I _L =90mA	I _F	-	0.55	2	mA
Input Control Current to Deactivate	-	I _F	0.2	-	-	
Input Voltage Drop	I _F =5mA	V _F	0.9	1.2	1.4	V
Reverse Input Current	V _R =5V	I _R	-	-	10	μA
Common Characteristics						
Input to Output Capacitance	V _{IO} =0V, f=1MHz	C _{IO}	-	3	-	pF

¹ Measurement taken within 1 second of on-time.

Timing Diagram

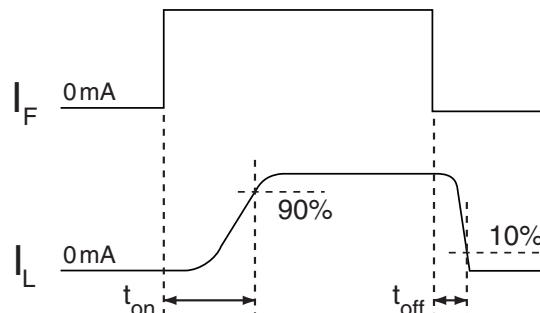

PERFORMANCE DATA @25°C (Unless Otherwise Noted)*

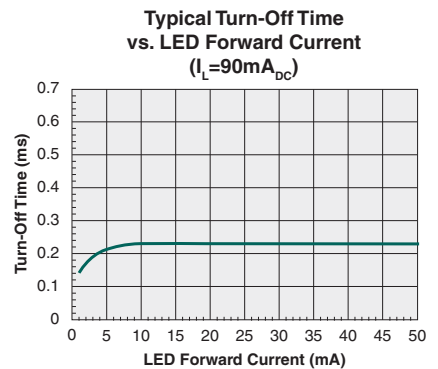
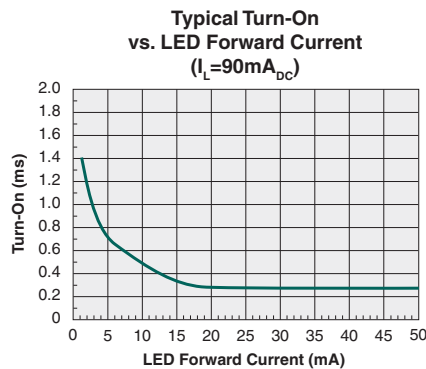
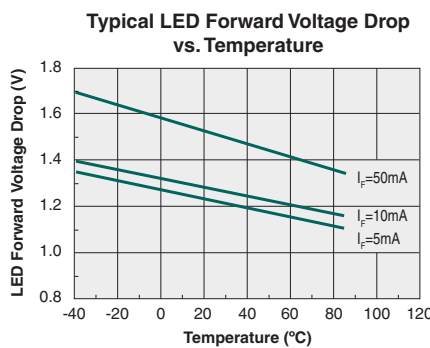
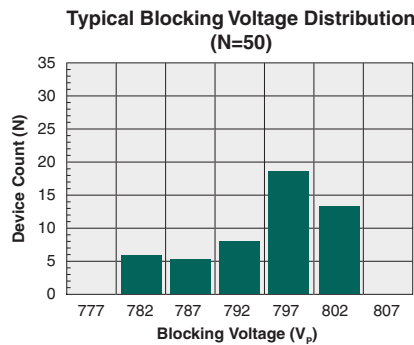
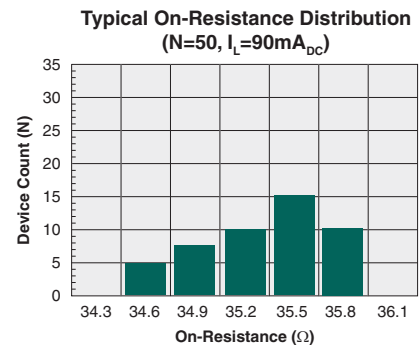
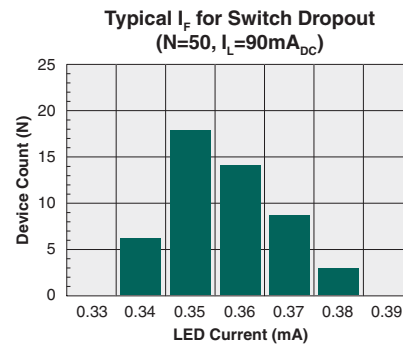
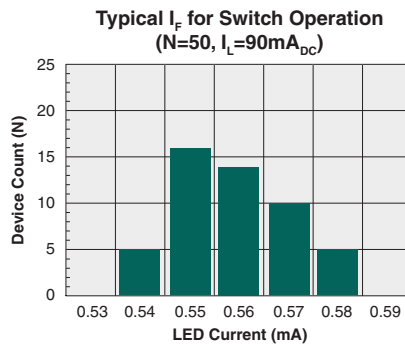
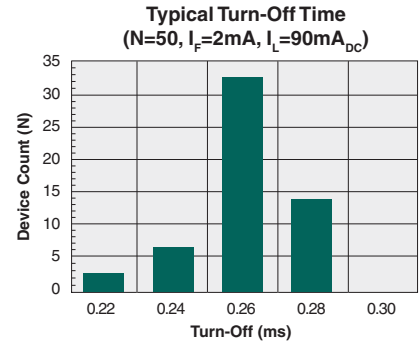
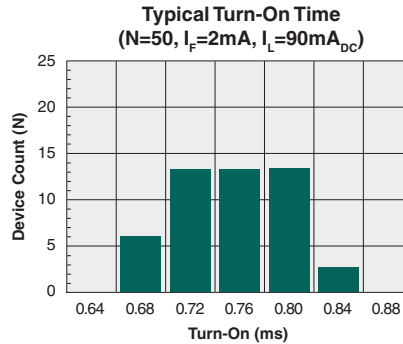
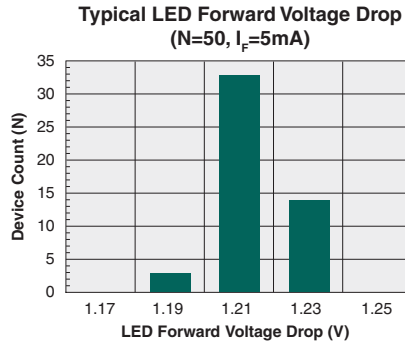

*The Performance data shown in the graphs above is typical of device performance. For guaranteed parameters not indicated in the written specifications, please contact our application department.

PERFORMANCE DATA @25°C (Unless Otherwise Noted)*

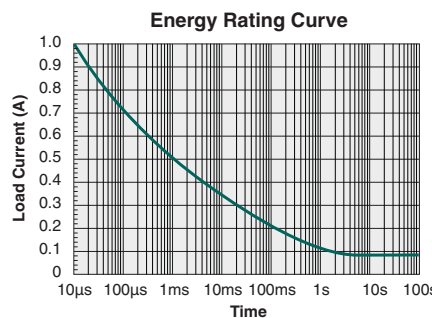
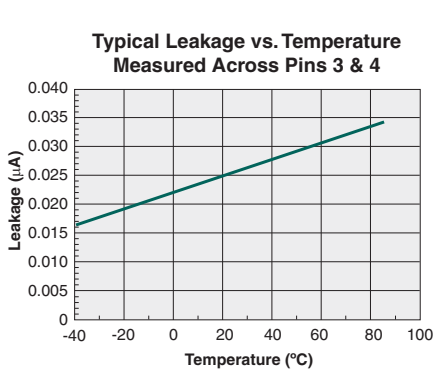
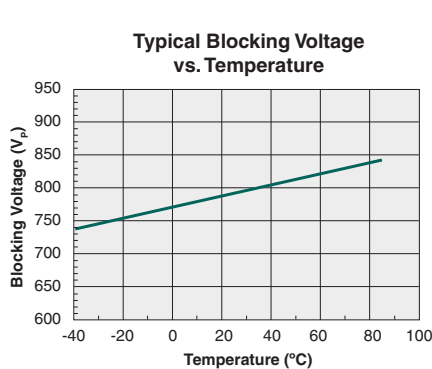
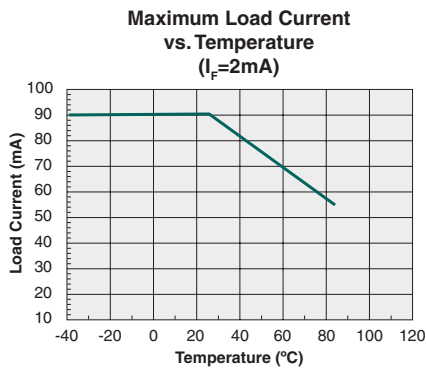
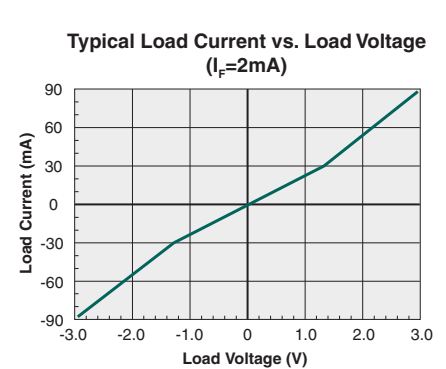
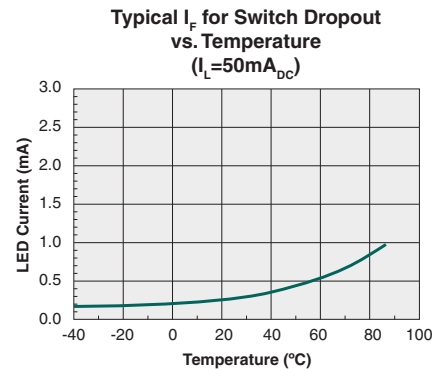
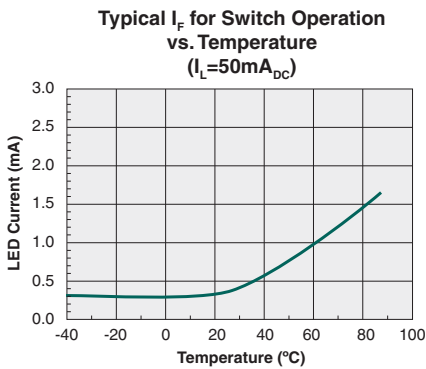
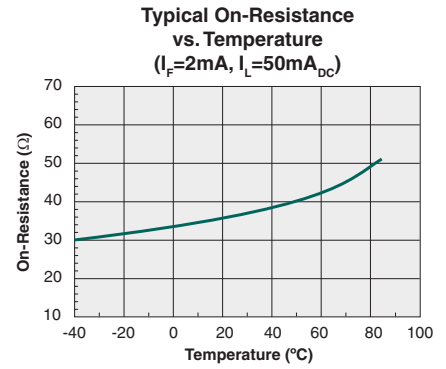
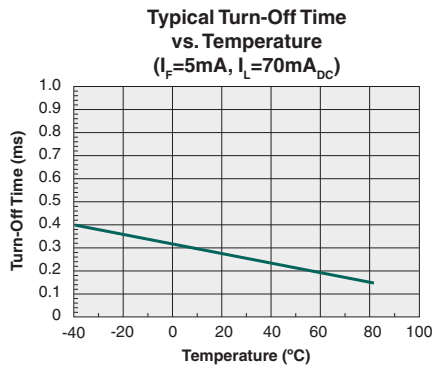
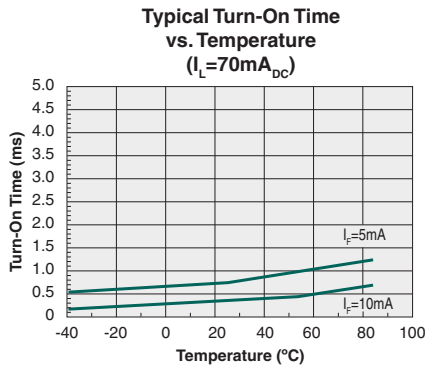

*The Performance data shown in the graphs above is typical of device performance. For guaranteed parameters not indicated in the written specifications, please contact our application department.

Manufacturing Information

Moisture Sensitivity



All plastic encapsulated semiconductor packages are susceptible to moisture ingress. IXYS Integrated Circuits Division classified all of its plastic encapsulated devices for moisture sensitivity according to the latest version of the joint industry standard, **IPC/JEDEC J-STD-020**, in force at the time of product evaluation. We test all of our products to the maximum conditions set forth in the standard, and guarantee proper operation of our devices when handled according to the limitations and information in that standard as well as to any limitations set forth in the information or standards referenced below.

Failure to adhere to the warnings or limitations as established by the listed specifications could result in reduced product performance, reduction of operable life, and/or reduction of overall reliability.

This product carries a **Moisture Sensitivity Level (MSL) rating** as shown below, and should be handled according to the requirements of the latest version of the joint industry standard **IPC/JEDEC J-STD-033**.

Device	Moisture Sensitivity Level (MSL) Rating
CPC1393G / CPC1393GV	MSL 1
CPC1393GR	MSL 3

ESD Sensitivity



This product is **ESD Sensitive**, and should be handled according to the industry standard **JESD-625**.

Soldering Profile

Provided in the table below is the Classification Temperature (T_C) of this product and the maximum dwell time the body temperature of this device may be above ($T_C - 5$)°C. The classification temperature sets the Maximum Body Temperature allowed for this device during lead-free reflow processes. Additionally, for the CPC1393GR, the solder reflow profile given in Technical Brief TB-200 "**Pb-Free Solder Reflow Profile for Select Devices**" must be followed. For the through-hole devices, CPC1393G and CPC1393GV, and any other processes, the guidelines of **J-STD-020** must be observed.

Device	Maximum Body Temperature (T_C)	Time
CPC1393GR	250°C	15 seconds

Board Wash

IXYS Integrated Circuits Division recommends the use of no-clean flux formulations. Board washing to reduce or remove flux residue following the solder reflow process is acceptable provided proper precautions are taken to prevent damage to the device. These precautions include, but are not limited to: using a low pressure wash and providing a follow-up bake cycle sufficient to remove any moisture trapped within the device due to the washing process. Due to the variability of the wash parameters used to clean the board, determination of the bake temperature and duration necessary to remove the moisture trapped within the package is the responsibility of the user (assembler). Cleaning or drying methods that employ ultrasonic energy may damage the device, and should not be used. Additionally, the device must not be exposed to flux or solvents that are Chlorine- or Fluorine-based.



MECHANICAL DIMENSIONS

CPC1393G

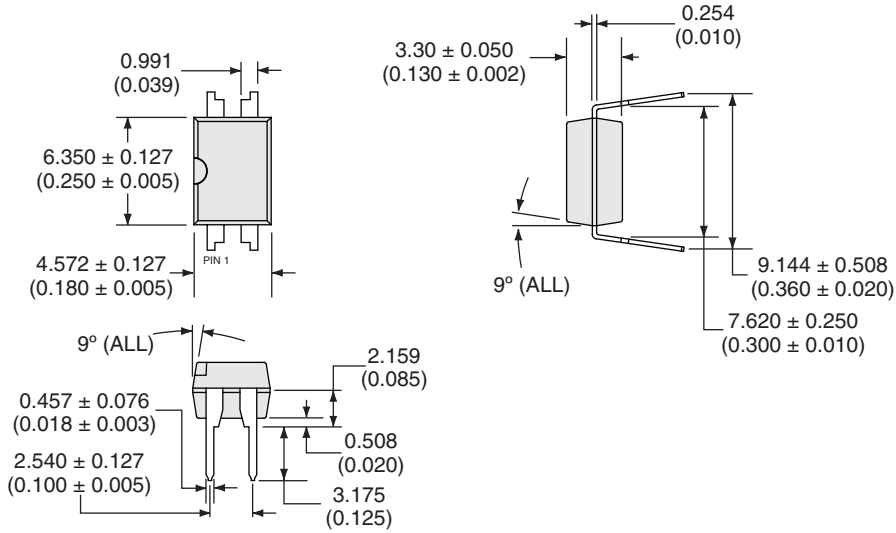

PC Board Pattern (Top View)

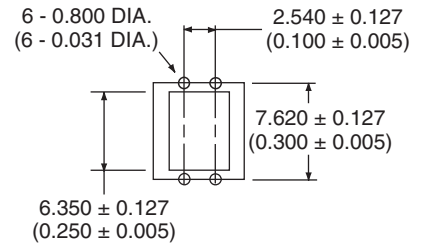

Dimensions
mm
(inches)

CPC1393GV

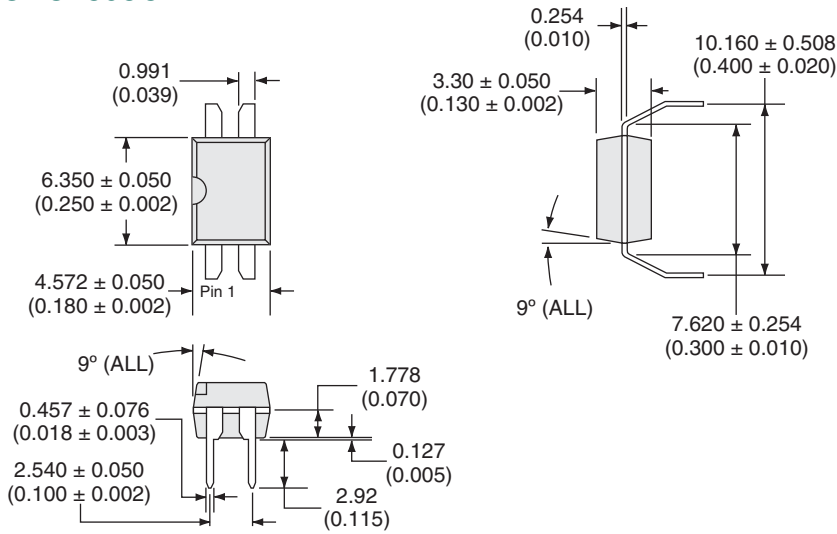

PC Board Pattern (Top View)

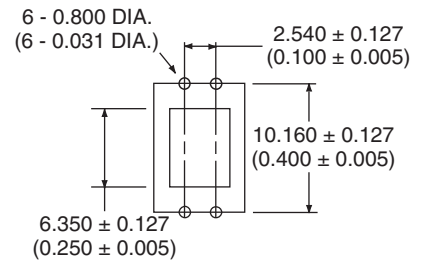

Dimensions
mm
(inches)

CPC1393GR

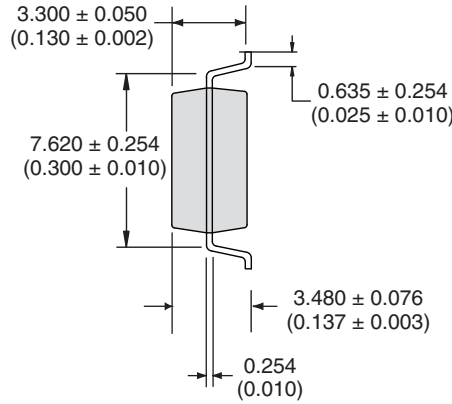
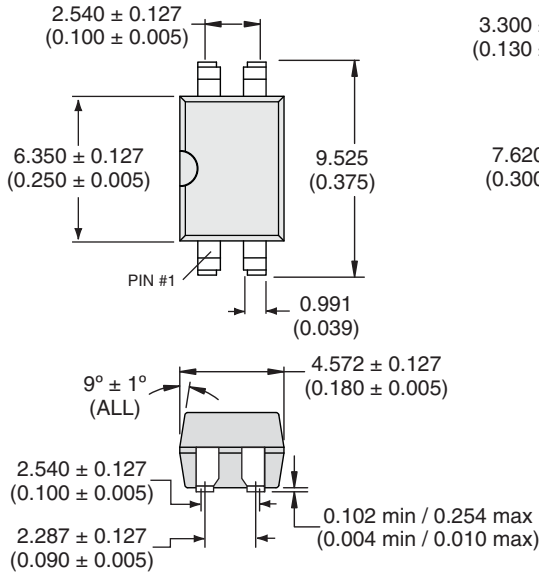

PCB Land Pattern

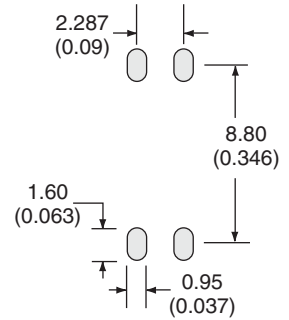

Dimensions
mm
(inches)

CPC1393GRTR Tape & Reel

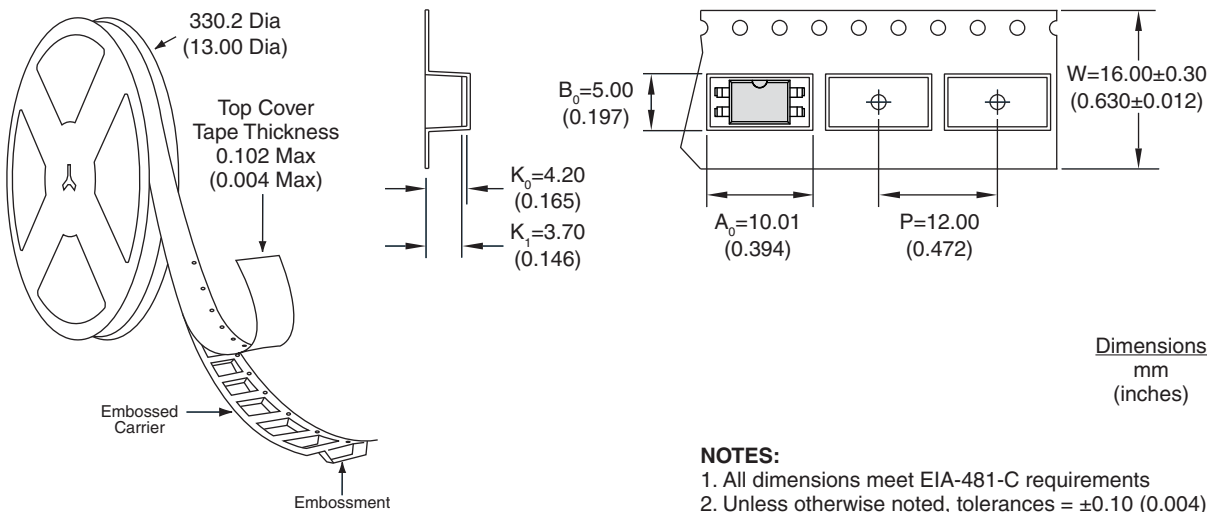

Dimensions
mm
(inches)

NOTES:

1. All dimensions meet EIA-481-C requirements
2. Unless otherwise noted, tolerances = ±0.10 (0.004)

For additional information please visit our website at: www.ixysic.com

IXYS Integrated Circuits Division makes no representations or warranties with respect to the accuracy or completeness of the contents of this publication and reserves the right to make changes to specifications and product descriptions at any time without notice. Neither circuit patent licenses nor indemnity are expressed or implied. Except as set forth in IXYS Integrated Circuits Division's Standard Terms and Conditions of Sale, IXYS Integrated Circuits Division assumes no liability whatsoever, and disclaims any express or implied warranty, relating to its products including, but not limited to, the implied warranty of merchantability, fitness for a particular purpose, or infringement of any intellectual property right.

The products described in this document are not designed, intended, authorized or warranted for use as components in systems intended for surgical implant into the body, or in other applications intended to support or sustain life, or where malfunction of IXYS Integrated Circuits Division's product may result in direct physical harm, injury, or death to a person or severe property or environmental damage. IXYS Integrated Circuits Division reserves the right to discontinue or make changes to its products at any time without notice.