



Parameter	Rating	Units
Blocking Voltage	600	V _P
Load Current	120	mA
Max On-resistance	35	Ω

Features

- 5000V_{rms} Input/Output Isolation
- 600V_P Blocking Voltage
- 100% Solid State
- Small 4-Pin Package
- Low Drive Power Requirements (TTL/CMOS Compatible)
- Arc-Free With No Snubbing Circuits
- No EMI/RFI Generation
- Machine Insertable, Wave Solderable

Applications

- Instrumentation
 - Multiplexers
 - Data Acquisition
 - Electronic Switching
 - I/O Subsystems
 - Meters (Watt-Hour, Water, Gas)
- Medical Equipment—Patient/Equipment Isolation
- Security
- Aerospace
- Industrial Controls

Description

The CPC1394 is a single-pole normally-open (1-Form-A) Solid State Relay with an enhanced input to output isolation barrier of 5000V_{rms}. Clare's patented OptoMOS architecture makes available the optically coupled technology necessary to activate the output's efficient MOSFET switches. Control of the isolated output is accomplished by means of the highly effective GaAIAs infrared LED at the input.

Approvals

- UL Recognized Component: File # E76270
- EN/IEC 60950 Compliant
- CSA Certified Component: Certificate # 1172007

Ordering Information

Part Number	Description
CPC1394G	4-Pin DIP (100/Tube)
CPC1394GV	4-Pin DIP V-Bend (100/Tube)
CPC1394GR	4-Pin Surface Mount (100/Tube)
CPC1394GRTR	4-Pin Surface Mount (1000/Reel)

Pin Configuration

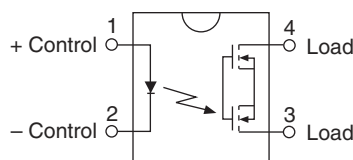

Switching Characteristics of Normally Open (Form A) Devices

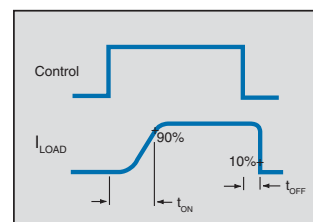

Absolute Maximum Ratings

Parameter	Ratings	Units
Peak Blocking Voltage	600	V_P
Reverse Input Voltage	5	V
Input Control Current	50	mA
Peak (10ms)	1	A
Input Power Dissipation ¹	100	mW
Total Package Dissipation ²	550	mW
Isolation Voltage, Input to Output	5000	V_{rms}
Operational Temperature	-40 to +85	°C
Storage Temperature	-40 to +125	°C

¹ Derate Linearly 1.33 mW/°C

² Derate Linearly 3.00 mW/°C

Electrical absolute maximum ratings are at 25°C

Absolute Maximum Ratings are stress ratings. Stresses in excess of these ratings can cause permanent damage to the device. Functional operation of the device at conditions beyond those indicated in the operational sections of this data sheet is not implied.

Electrical Characteristics

Parameters	Conditions	Symbol	Min	Typ	Max	Units
Output Characteristics @ 25°C						
Load Current						
Continuous	-	I_L	-	-	120	mA
Peak	t=10ms	I_{LPK}	-	-	400	
On-resistance ¹	$I_L=120mA$	R_{ON}	-	26	35	Ω
Off-State Leakage Current	$V_L=600V_P$	I_{LEAK}	-	-	1	μA
Switching Speeds						
Turn-On	$I_F=5mA, V_L=10V$	T_{ON}	-	0.85	5	ms
Turn-Off		T_{OFF}	-	0.46	3	
Output Capacitance	$I_F=0mA, V_L=50V, f=1MHz$	C_{OUT}	-	50	-	pF
Input Characteristics @ 25°C						
Input Control Current ²	$I_L=120mA$	I_F	-	0.45	2	mA
Input Dropout Current	-	I_F	0.2	0.4	-	
Input Voltage Drop	$I_F=5mA$	V_F	0.9	1.2	1.4	V
Reverse Input Current	$V_R=5V$	I_R	-	-	10	μA
Common Characteristics @ 25°C						
Input to Output Capacitance	-	C_{IO}	-	3	-	pF

¹ Within 1 second of time.

² For temperatures >60°C, an LED current of 4mA is recommended.

PERFORMANCE DATA*

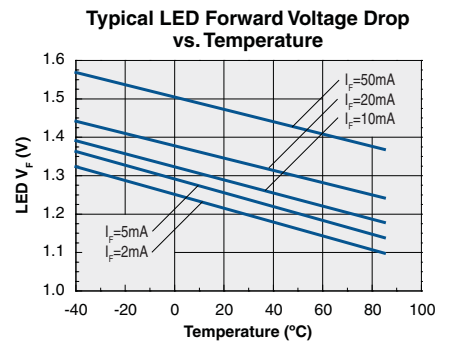
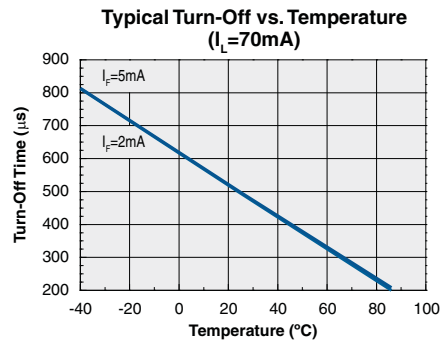
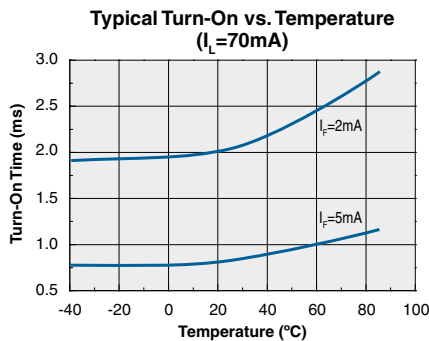
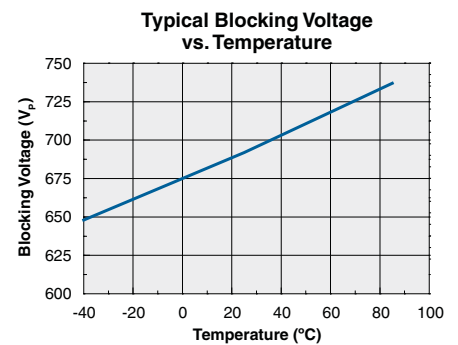
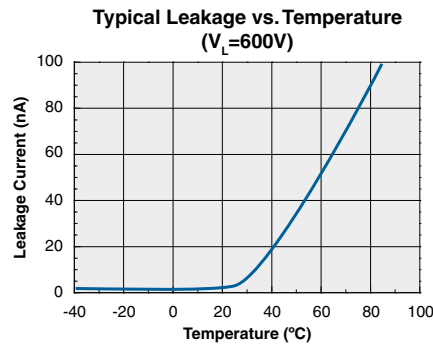
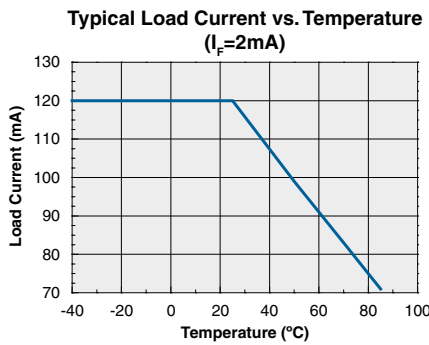
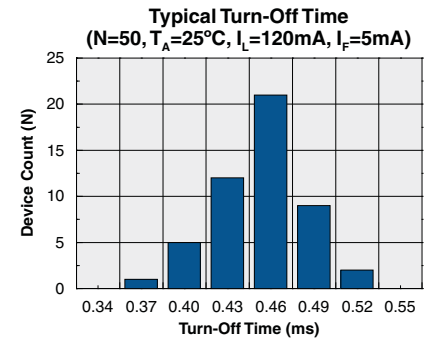
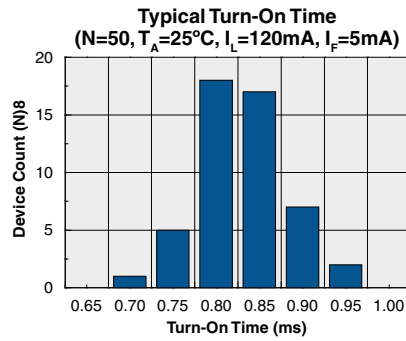
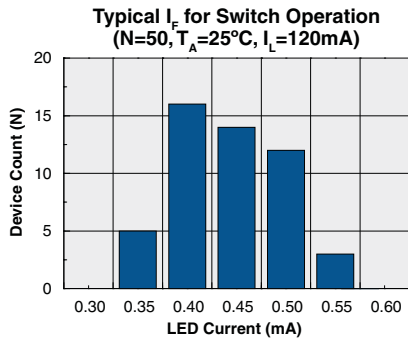
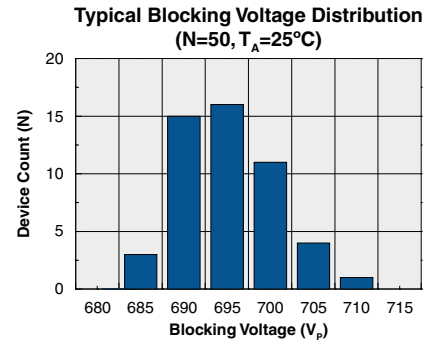
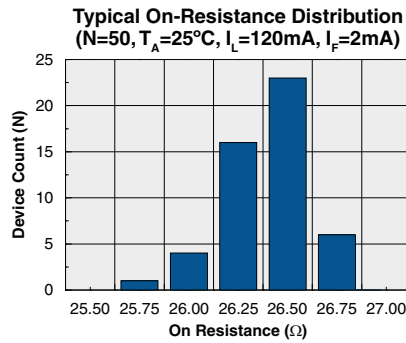
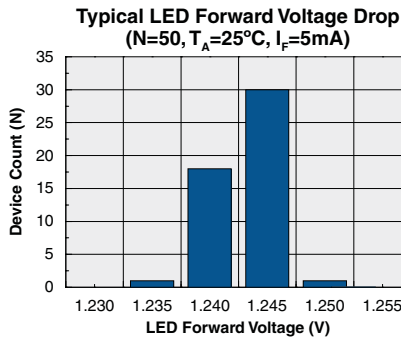

*The Performance data shown in the graphs above is typical of device performance. For guaranteed parameters not indicated in the written specifications, please contact our application department.

PERFORMANCE DATA*

Typical Turn-On vs. LED Forward Current
($T_A=25^{\circ}\text{C}$, $I_L=70\text{mA}$)

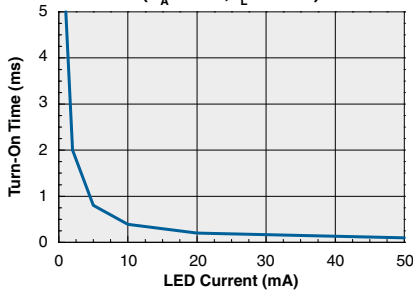

Typical Turn-Off vs. LED Forward Current
($T_A=25^{\circ}\text{C}$, $I_L=70\text{mA}$)

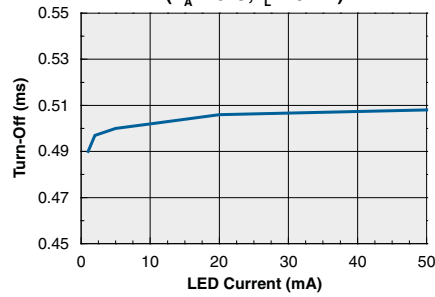

Typical On-Resistance vs. Temperature
($I_L=70\text{mA}$, $I_F=2\text{mA}$)

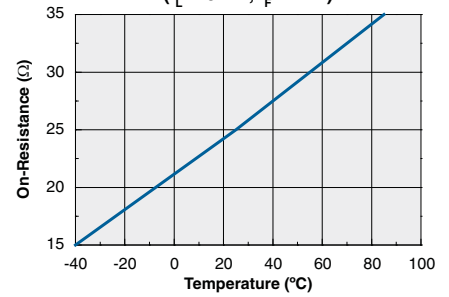

Typical I_F for Switch Operation vs. Temperature
($I_L=70\text{mA}$)

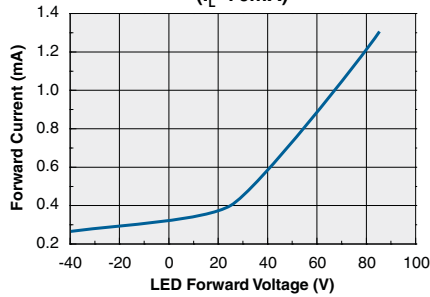

Typical Load Current vs. Load Voltage
($I_F=2\text{mA}$)

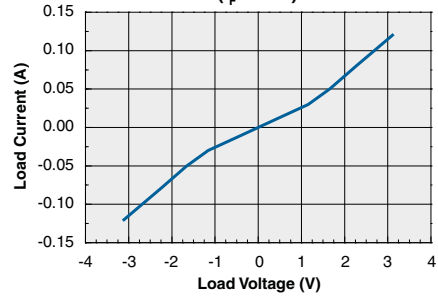

Energy Rating Curve

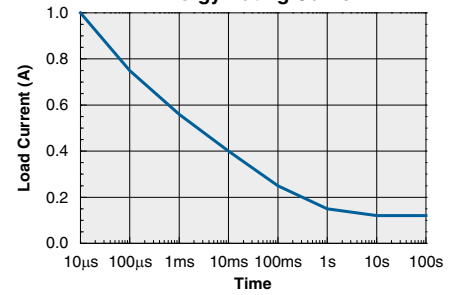

*The Performance data shown in the graphs above is typical of device performance. For guaranteed parameters not indicated in the written specifications, please contact our application department.

Manufacturing Information

Soldering

For proper assembly, the component must be processed in accordance with the current revision of IPC/JEDEC standard J-STD-020. Failure to follow the recommended guidelines may cause permanent damage to the device resulting in impaired performance and/or a reduced lifetime expectancy.

Washing

Clare does not recommend ultrasonic cleaning or the use of chlorinated solvents.



MECHANICAL DIMENSIONS

4-Pin DIP ("G" Suffix)

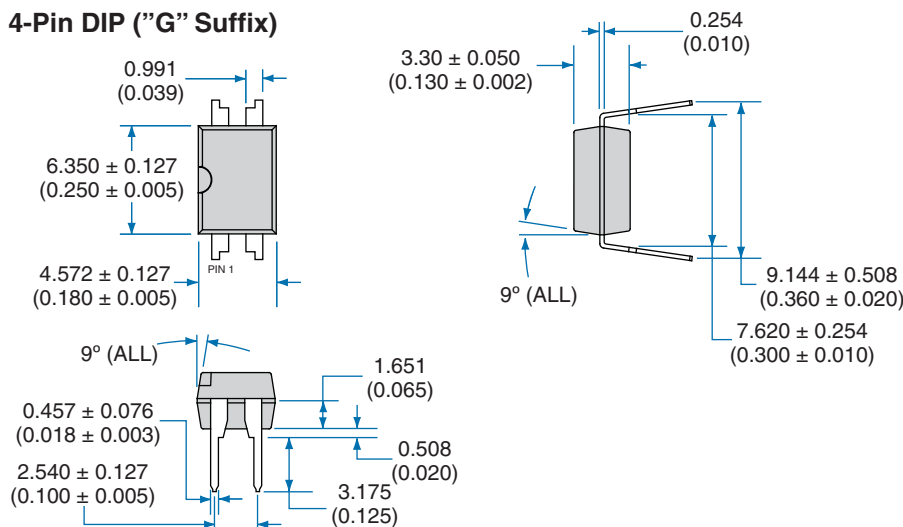

PC Board Pattern (Top View)

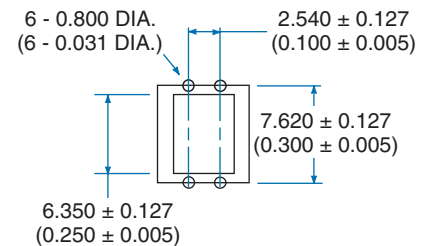

Dimensions
mm
(inches)

4-Pin DIP "GV" Package

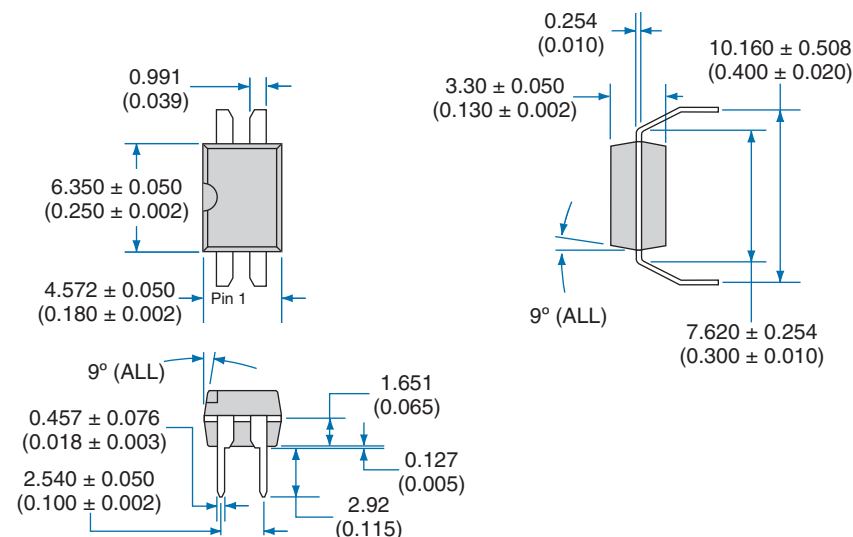

PC Board Pattern (Top View)

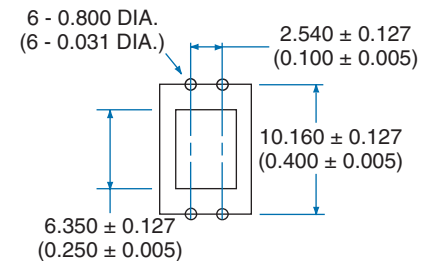

Dimensions
mm
(inches)

MECHANICAL DIMENSIONS

4-Pin Surface Mount ("GR" Suffix)

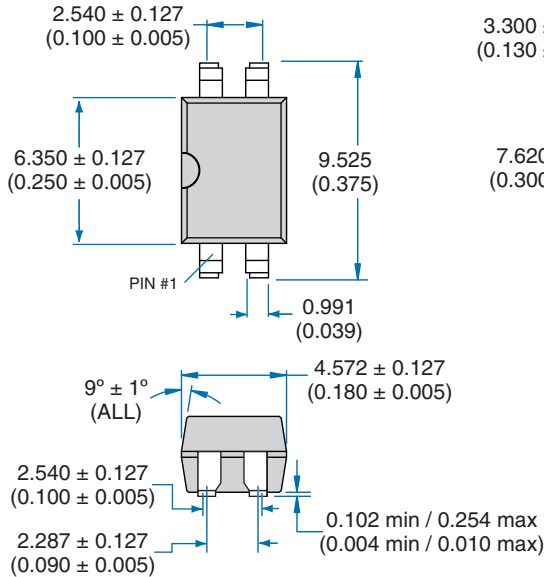

Recommended PCB Land Pattern

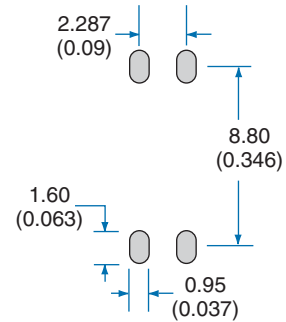

Dimensions
mm
(inches)

Tape and Reel Packaging for 4-Pin Surface Mount Package

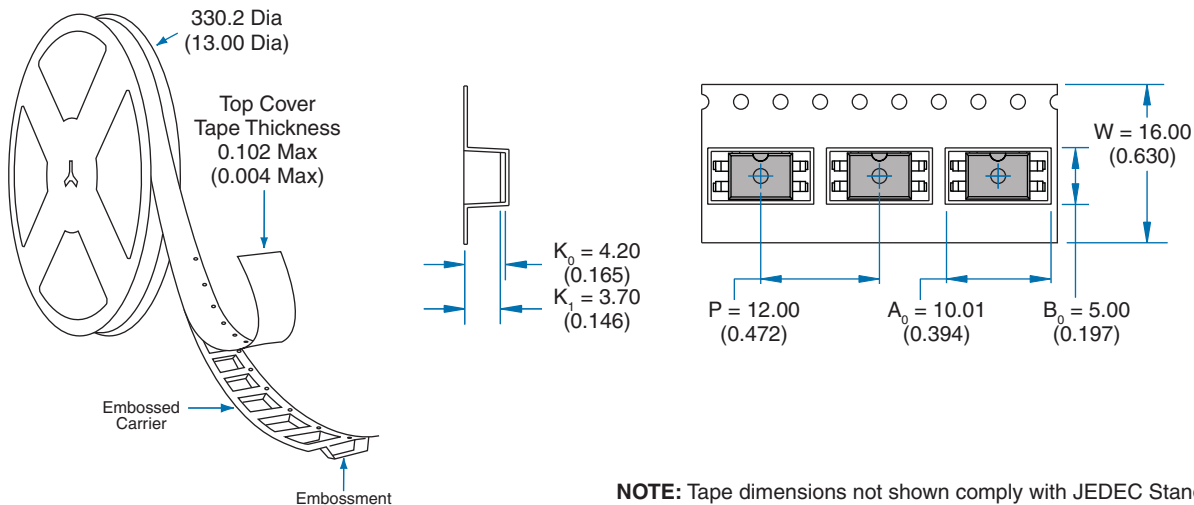

Dimensions
mm
(inches)

NOTE: Tape dimensions not shown comply with JEDEC Standard EIA-481-2

For additional information please visit our website at: www.clare.com

Clare, Inc. makes no representations or warranties with respect to the accuracy or completeness of the contents of this publication and reserves the right to make changes to specifications and product descriptions at any time without notice. Neither circuit patent licenses nor indemnity are expressed or implied. Except as set forth in Clare's Standard Terms and Conditions of Sale, Clare, Inc. assumes no liability whatsoever, and disclaims any express or implied warranty, relating to its products including, but not limited to, the implied warranty of merchantability, fitness for a particular purpose, or infringement of any intellectual property right.

The products described in this document are not designed, intended, authorized or warranted for use as components in systems intended for surgical implant into the body, or in other applications intended to support or sustain life, or where malfunction of Clare's product may result in direct physical harm, injury, or death to a person or severe property or environmental damage. Clare, Inc. reserves the right to discontinue or make changes to its products at any time without notice.