

PROCESS CPD48V
Schottky Diode
High Current Schottky Diode Chip



PROCESS DETAILS

Process	EPITAXIAL PLANAR
Die Size	13.8 x 13.8 MILS
Die Thickness	7.1 MILS
Anode Bonding Pad Area	9.0 x 9.0 MILS
Top Side Metalization	Al - 30,000Å
Back Side Metalization	Au - 12,000Å

GEOMETRY

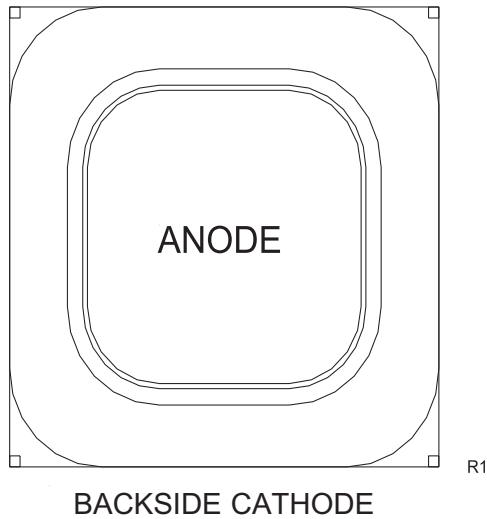

GROSS DIE PER 5 INCH WAFER

89,720

PRINCIPAL DEVICE TYPES

CMP SH-3 Series
CMSSH-3 Series
CMXSH-3
CMKSH-3T

R3 (22-March 2010)

PROCESS CPD48V

Typical Electrical Characteristics

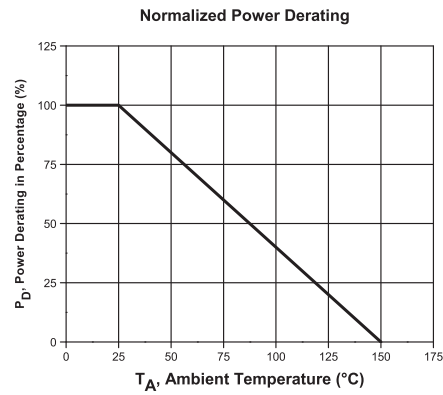
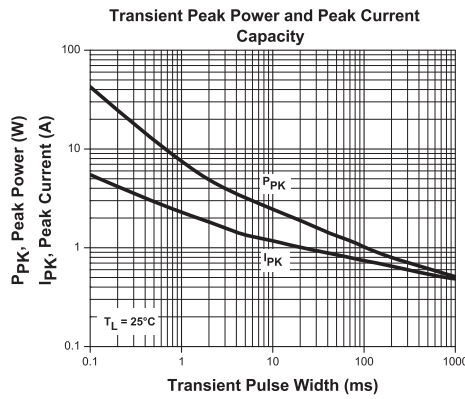
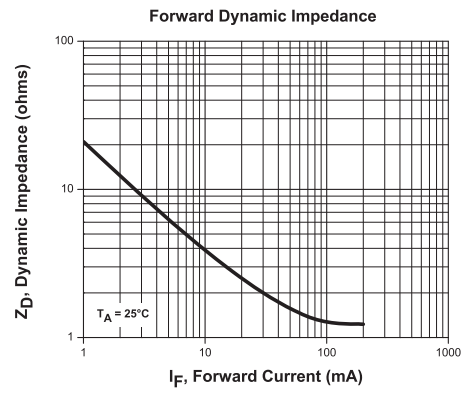
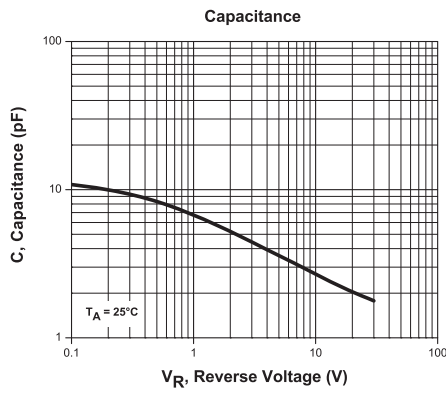
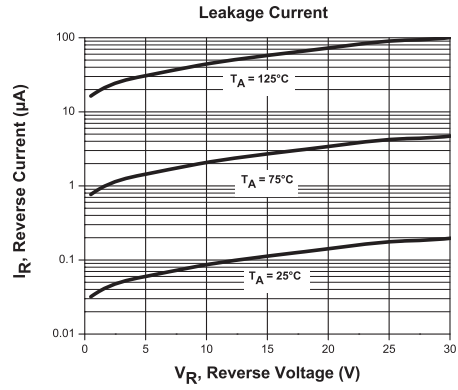
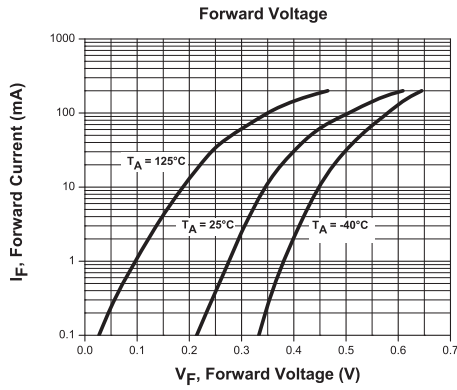

R3 (22-March 2010)