

# SiBOD™ Series

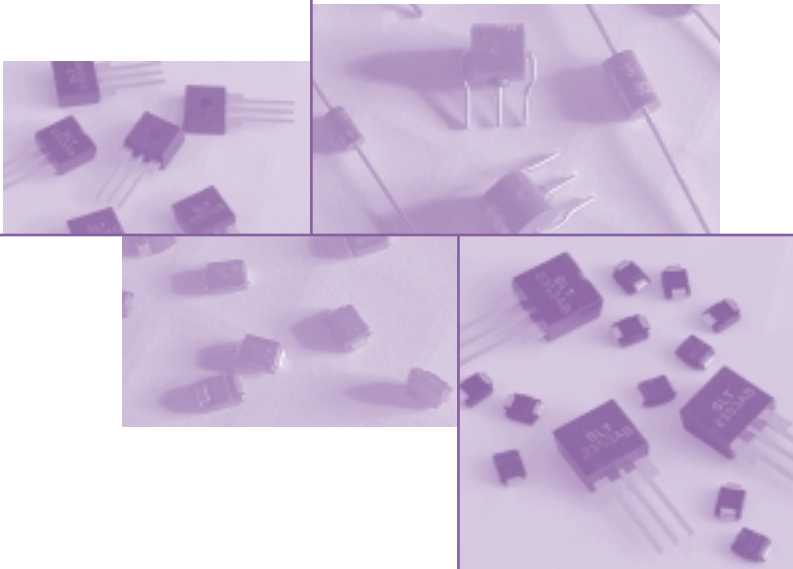

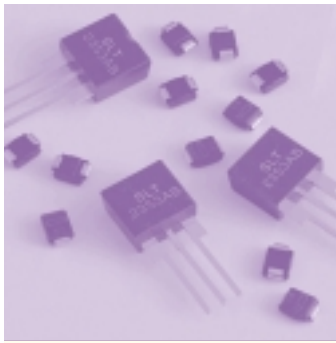

### Specify Crydom

... for these industry-leading components and products:

- **Solid State Relays**
  - Printed Circuit Board Mount
  - Panel Mount
  - DIN Rail Mount
- **Power Cubes**
- **I/O Modules**
- **Transient Voltage Suppression Components**
  - TVS Diodes
  - Thyristor Suppression Devices
  - Gas Discharge Tubes (GDT)
  - Zeners/Studs
  - Hybrid Arrester Devices

### Get TVS Insurance From The People Who Know

*There's too much riding on over-voltage surge protection to take chances. That's why more and more people are turning to Crydom.*

#### Why?

To start with, we don't just sell TVS components – we're the only company developing, designing and manufacturing all five of the basic product families: Transient Voltage Suppression (TVS) Diodes. SiBOD™ Thyristor Suppression Devices. Gas Discharge Tubes (GDT). Hybrid Arrester Over-Voltage Surge Protectors. Zeners/Studs. And the only company employing all three voltage protection technologies – gas tube, semiconductor and hybrid.

That means we're the only one who knows them inside and out. What each type can and can't do. Which type to use for different applications. How to provide as much or little technical support as you need. How to work with you to develop special devices should you require them. And even assist you in formulating design requirements and testing procedures to meet both your specifications and international standards.

### Crydom's SiBOD Series Equals "Crow Bar" Protection

*To protect sensitive telecommunications circuitry, Crydom Thyristors (SiBOD™ Breakover Devices) "crow bar" potentially dangerous transients – switching them to ground and dissipating the voltage to zero. This approach can handle more energy than TVS diode "clamping."*

#### FEATURES

- Glass passivated junction
- Bi-directional transient voltage protection
- Nano second clamping response
- Surge capability up to 500 amps
- No performance degradation under service life

#### BENEFITS

- One component cost for +ve and -ve protection
- Excellent voltage protection levels
- Can be used for primary or secondary protection
- No replacement required ie, no maintenance cost
- Highest level of quality and reliability
- Low cost auto assembly

#### MECHANICAL CHARACTERISTICS

- Transfer molded, void free epoxy body
- Tin/Lead plated leads
- Maximum case temperature for soldering purposes: 230°C for 10 seconds

# SiBOD Series Application Notes

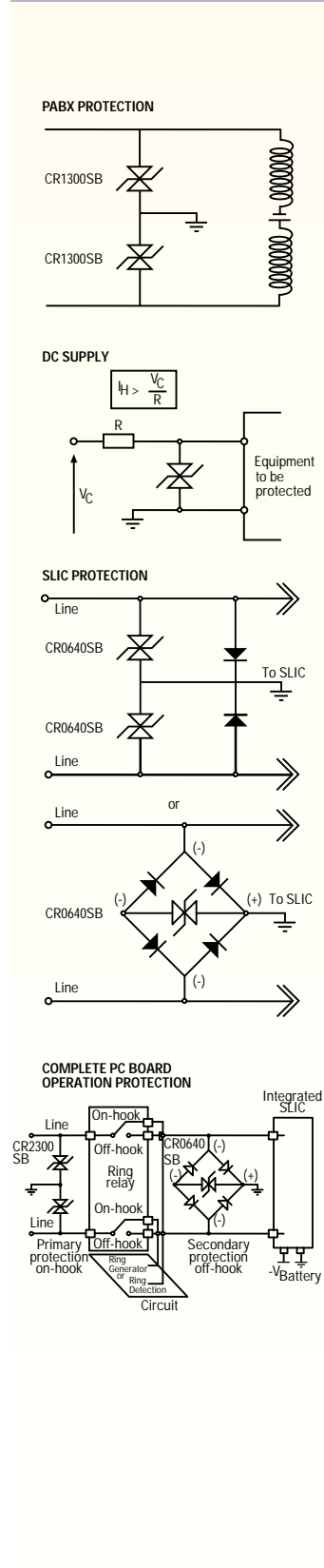

*The Added Crydom Benefit*  
 Crydom Thyristors (SiBOD™ Breakover Devices) offer the highest quality and performance. They also come with an added benefit – service and technical assistance to help ensure optimum protection for your telecommunications application.

### SiBOD Series

The Crydom SiBOD is a four-layer thyristor-based protector designed specifically for telecommunications applications. It has greater capacity for diverting surge currents than an avalanche TVS device.

The Crydom series protector is based on the proven technology of the SiBOD product. Designed for transient voltage protection of telecommunications equipment, it provides higher power handling than a conventional avalanche diode (TVS), and when compared to a GDT offers lower voltage clamping levels and infinite surge life.

### Electrical Characteristics

The electrical characteristics of the SiBOD devices are similar to those of a self-gated Triac, but the SiBOD are two-terminal devices with no gate. The gate function is achieved by an internal current controlled mechanism.

Like the TVS diodes, the SiBOD have a stand-off voltage ( $V_{RM}$ ) that should be equal to or greater than the operating voltage of the system to be protected. At this voltage ( $V_{RM}$ ) the current consumption of the SiBOD are negligible and will not effect the protected system.

When a transient occurs, the voltage across the SiBOD will increase until the breakdown voltage ( $V_{BR}$ ) is reached. At this point the device will operate in a similar way to a TVS device and is in an avalanche mode.

The voltage of the transient will now be limited and will only increase by a few volts as the device diverts more current. As this transient current rises, a level of current through the device is reached ( $I_{BO}$ ), causing the device to switch to a fully conductive state such that the voltage across the device is now only a few volts ( $V_T$ ). The voltage at which the device switches from the avalanche mode to the fully conductive state ( $V_T$ ) is known as the breakover voltage ( $V_{BO}$ ). When the device is in the  $V_T$  state, high currents can be diverted without damage to the SiBOD due to the low voltage across the device, since the limiting factor in such devices is dissipated power ( $V \times I$ ).

Resetting of the device to the nonconducting state is controlled by the current flowing through the device. When the current falls below a certain value, known as the holding current ( $I_H$ ), the device resets automatically.

As with the avalanche TVS device, if the SiBOD device is subjected to a surge current that is beyond its maximum rating, the device will fail in short-circuit mode, which ensures that the equipment is ultimately protected.

**Selecting a SiBOD Device**

- When selecting a device, it is important that the  $V_{RM}$  of the device be equal to or greater than the operating voltage of the system. For example, when protecting the ringing circuit of a telephone handset, SiBOD  $V_{RM} > V_{DC} + \text{RINGING VOLTAGE}$   
SiBOD  $V_{RM} > V_{DC} + \sqrt{2} \times \text{RINGING VOLTAGE}$
- The minimum holding current ( $I_H$ ) of the device must be carefully selected if the SiBOD is to reset after diverting a surge. The minimum  $I_H$  value of the SiBOD must be greater than the current the system is capable of delivering, otherwise the device will remain conducting following a transient condition.

$$I_H > \frac{\text{SYSTEM VOLTAGE}}{\text{SOURCE IMPEDANCE}}$$

**The SiBOD range can be used to protect against surges as defined in the following International Standards**

Standard	VOLTAGE VOLTS	WAVEFORM $\mu\text{SEC}$	CURRENT AMPS	WAVEFORM $\mu\text{SEC}$	SiBOD SERIES
FCC Part 68					
Surge A Metallic	800	10x560	100	10x560	B or C
Surge A Longitudinal	1500	10x160	200	10x160	C
Surge B Metallic	1000	9x720	25	5x320	A, B or C
Surge B Longitudinal	1500	9x720	37.5	5x320	A, B or C
Bellcore GR 1089					
1	600	10x1000	100	10x1000	C
2	1000	10x360	100	10x360	B or C
3	1000	10x1000	100	10x1000	C
4	2500	2x10	500	2x10	C
5	1000	10x360	25	10x360	A, B or C
ITU K.17	1500	10x700	37.5	5x310	A, B or C
ITU K.20	1000	10x700	25/100	5x310	A, B or C
ITU K.21	1500	10x700	37.5	5x310	A, B or C
	4000	10x700	100	5x310	B or C
RLM 88, CNET	1500	.5x700	38	.2x310	A, B or C
CNET 131-24	1000	.5x700	25	.8x310	A, B or C
VDE 0433	2000	10x700	50	5x310	A, B or C
VDE 0878	2000	1.2x50	50	1x20	A, B or C
IEC 61000-4-5	Level 3	10x700	50	5x310	A, B or C
	Level 4	1.2x50	100	8x20	A, B or C
FTZ R12	2000	10x700	50	5x310	A, B or C

# SiBOD Series

V-I Graph Illustrating Symbols and Terms for the SiBOD Surge Protection Devices

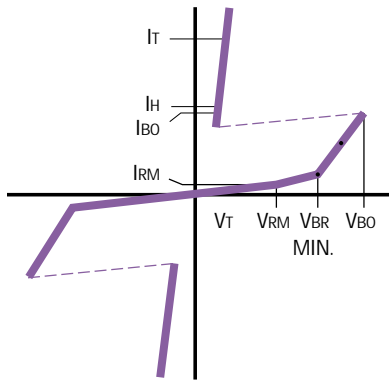

## ELECTRICAL CHARACTERISTICS (Tj = 25°C)

SYMBOL	PARAMETER
VRM	Stand-off voltage
VBR	Breakdown voltage
VBO/Vs	Breakover voltage
VT	On-state voltage
IRM	Stand-off current
IBO	Breakover current
IH	Holding current
Co	Off state Capacitance
Ipp	Peak pulse current

Typical Vbo Change vs. Junction Temperature

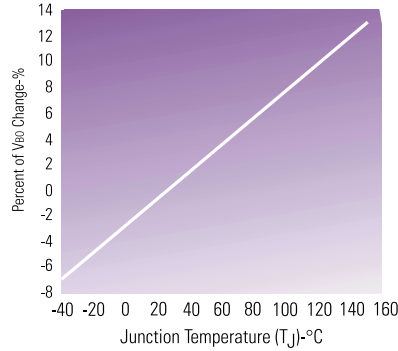

Typical DC Holding Current vs. Case Temperature

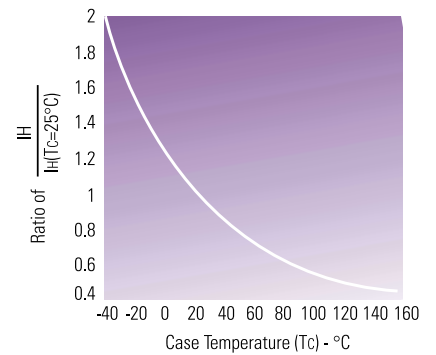

Pulse Wave Form (10/1000 μs)

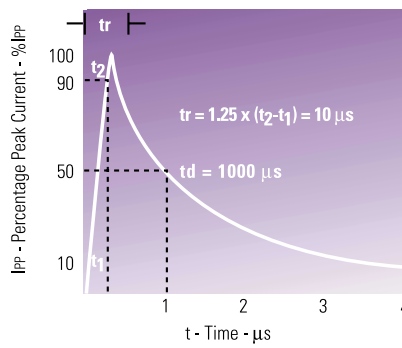

1.2/50 μs Impulse Discharge Voltage Waveshape

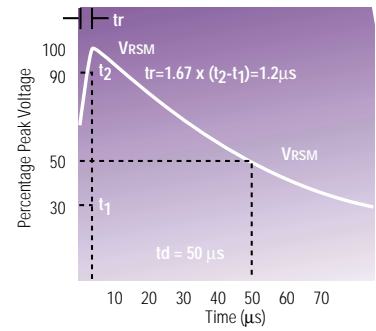

8/20 μs Impulse Discharge Current Waveshape

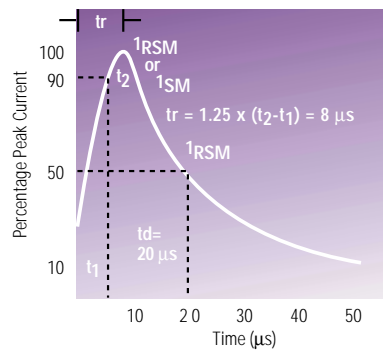

## ABSOLUTE RATINGS

SYMBOL	PARAMETER	VALUE			UNIT
		DO-214	TO-220	T10	
T stg	Storage and operating junction temperature range	-40 to 150	-40 to 150	-40 to 150	°C
Tj		150	150	150	°C
Tl	Maximum temperature for soldering (For period of 10 seconds max.)	230	230	230	°C
Tc	Maximum case temperature	75	115	75	°C



DO-214

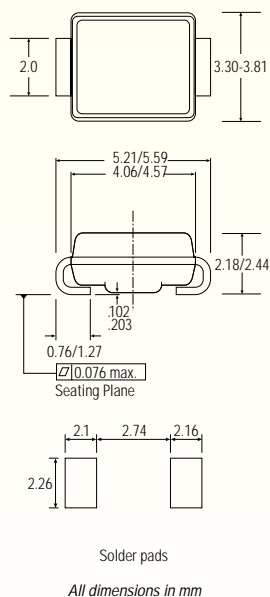

TAPE & REEL PACKAGING

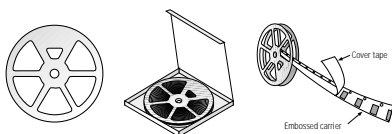

JEDEC CASE TYPE	TAPE WIDTH (mm)	QUANTITY PER REEL 330mm Reel (øD) (T3)
DO-214AA	12	3000

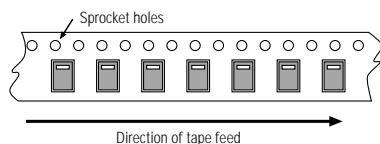

Our surface-mount components are placed in embossed cavities of anti-static/conductive carrier tape and sealed with a cover tape. The taped devices are supplied in reels in protective boxes. The standard Crydom lead-tape packaging of surface-mount components follow the requirements of EIA 481-1, shown below:

- Cover Tape: This will not extend over the edge of the carrier tape or extend over any part of the sprocket holes.
- Carrier Tape: This will release from the reel hub as the last portion of the tape unwinds from the reel without damage to the carrier tape and with the components remaining in the cavities.
- Leader Tape: A minimum length of 300mm leader (and trailer) of tape will be provided before the first (and after the last) component on the reel, with a minimum of forty empty component carrier pockets covered with tape.

Electrical Characteristics

Stock Number	Device Code	Reverse Stand-off Voltage (V <sub>R</sub> )	Maximum Breakover Voltage (V <sub>BO</sub> ) @ I <sub>BO</sub>	Maximum Voltage Turnon (V <sub>T</sub> ) @ 1A	Maximum Reverse Leakage (I <sub>R</sub> ) @ V <sub>R</sub>	Maximum Breakover Current (I <sub>BO</sub> )	Minimum Holding Current (I <sub>H</sub> )	* Typical Capacitance @1MHz 2V Bias
		V	V	V	µA	mA	mA	pF
CR0300 SA, SB, SC	030 A, B, or C	25	40	5	5	800.0	150.0	200.0
CR0640 SA, SB, SC	064 A, B, or C	58	77	5	5	800.0	150.0	120.0
CR0720 SA, SB, SC	072 A, B, or C	65	88	5	5	800.0	150.0	90.0
CR0800 SA, SB, SC	080 A, B, or C	75	98	5	5	800.0	150.0	90.0
CR1100 SA, SB, SC	110 A, B, or C	90	130	5	5	800.0	150.0	90.0
CR1300 SA, SB, SC	130 A, B, or C	120	160	5	5	800.0	150.0	60.0
CR1500 SA, SB, SC	150 A, B, or C	140	180	5	5	800.0	150.0	60.0
CR1800 SA, SB, SC	180 A, B, or C	160	220	5	5	800.0	150.0	60.0
CR2300 SA, SB, SC	230 A, B, or C	190	260	5	5	800.0	150.0	45.0
CR2600 SA, SB, SC	260 A, B, or C	220	300	5	5	800.0	150.0	45.0
CR3100 SA, SB, SC	310 A, B, or C	275	350	5	5	800.0	150.0	45.0
CR3500 SA, SB, SC	350 A, B, or C	320	400	5	5	800.0	150.0	45.0
CR4000 SA, SB, SC	400 A, B or C	375	450	5	5	800.0	150.0	45.0

\*Note: The typical capacitance values listed in this chart are for SA and SB. SC capacitance is approximately double that of SA and SB.

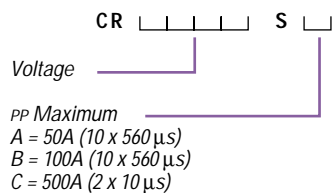

Peak Pulse	SA	SB	SC
2/10µs	-	-	500
8/20µs	150	250	400
10/160µs	100	150	200
10/560µs	50	100	-
10/1000µs	-	-	100

SiBOD Series  
TO-220



Electrical Characteristics (2 chip)

Part Number		Reverse Stand-off Voltage (V <sub>R</sub> )	Maximum Breakover Voltage (V <sub>BO</sub> ) @ I <sub>BO</sub>	Reverse Stand-off Voltage (V <sub>R</sub> )	Maximum Breakover Voltage (V <sub>BO</sub> ) @ I <sub>BO</sub>	Typical Voltage Turnon (V <sub>T</sub> ) @ 1A	Maximum Reverse Leakage (I <sub>R</sub> ) @ V <sub>R</sub>	Maximum Breakover Current (I <sub>BO</sub> )	Minimum Holding Current (I <sub>H</sub> )	* Typical Cap. @1MHz 2V Bias
		pins 1-2 & 3-2		pins 1-3						
		V	V	V	V	V	µA	mA	mA	pF
CR0602	AA, AB, AC	25.0	40.0	50.0	80.0	5.0	1.0	800.0	150.0	200.0
CR1402	AA, AB, AC	58.0	77.0	116.0	154.0	5.0	1.0	800.0	150.0	120.0
CR1602	AA, AB, AC	65.0	95.0	130.0	190.0	5.0	1.0	800.0	150.0	90.0
CR2202	AA, AB, AC	90.0	130.0	180.0	260.0	5.0	1.0	800.0	150.0	90.0
CR2702	AA, AB, AC	120.0	160.0	240.0	320.0	5.0	1.0	800.0	150.0	60.0
CR3002	AA, AB, AC	140.0	180.0	280.0	360.0	5.0	1.0	800.0	150.0	60.0
CR3602	AA, AB, AC	160.0	220.0	320.0	440.0	5.0	1.0	800.0	150.0	60.0
CR4202	AA, AB, AC	190.0	250.0	380.0	500.0	5.0	1.0	800.0	150.0	45.0
CR4802	AA, AB, AC	220.0	300.0	440.0	600.0	5.0	1.0	800.0	150.0	45.0
CR6002	AA, AB, AC	275.0	350.0	550.0	700.0	5.0	1.0	800.0	150.0	45.0

\*Note: The typical capacitance values listed in this chart are for AA and AB. AC capacitance is approximately double that of AA and AB.

Electrical Characteristics (3 chip)

Part Number		Reverse Stand-off Voltage (V <sub>R</sub> )	Maximum Breakover Voltage (V <sub>BO</sub> ) @ I <sub>BO</sub>	Reverse Stand-off Voltage (V <sub>R</sub> )	Maximum Breakover Voltage (V <sub>BO</sub> ) @ I <sub>BO</sub>	Typical Voltage Turnon (V <sub>T</sub> ) @ 1A	Maximum Reverse Leakage (I <sub>R</sub> ) @ V <sub>R</sub>	Maximum Breakover Current (I <sub>BO</sub> )	Minimum Holding Current (I <sub>H</sub> )	* Typical Cap. @1MHz 2V Bias
		pins 1-2 & 3-2		pins 1-3						
		V	V	V	V	V	µA	mA	mA	pF
CR1553	AA, AB, AC	130.0	180.0	130.0	180.0	10.0	5.0	800.0	150.0	60.0
CR1803	AA, AB, AC	150.0	210.0	150.0	210.0	10.0	5.0	800.0	150.0	60.0
CR2103	AA, AB, AC	170.0	250.0	170.0	250.0	10.0	5.0	800.0	150.0	60.0
CR2353	AA, AB, AC	200.0	270.0	200.0	270.0	10.0	5.0	800.0	150.0	60.0
CR2703	AA, AB, AC	230.0	300.0	230.0	300.0	10.0	5.0	800.0	150.0	45.0
CR3203	AA, AB, AC	270.0	350.0	270.0	350.0	10.0	5.0	800.0	150.0	45.0
CR3403	AA, AB, AC	300.0	400.0	300.0	400.0	10.0	5.0	800.0	150.0	45.0

\*Note: The typical capacitance values listed in this chart are for AA and AB. AC capacitance is approximately double that of AA and AB.

Peak Pulse	AA	AB	AC
2/10µs	-	-	500
8/20µs	150	250	400
10/160µs	100	150	200
10/560µs	50	100	-
10/1000µs	-	-	100

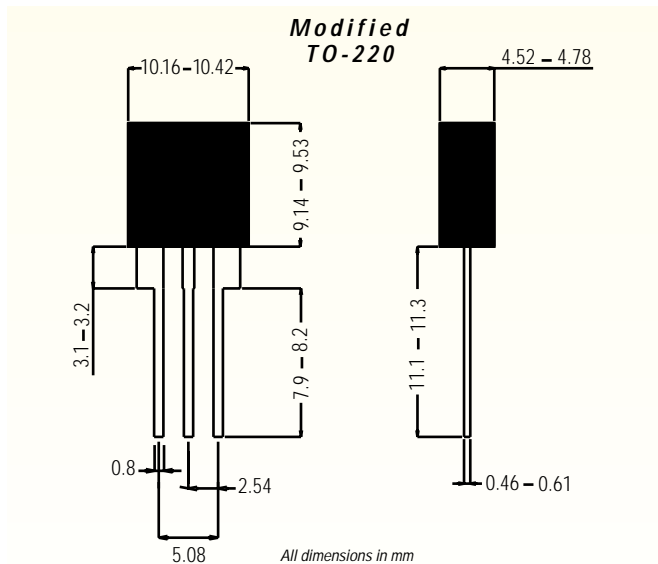
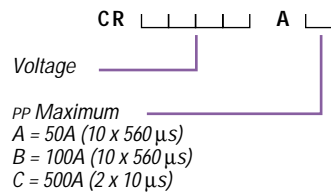

# SiBOD Series

## T10A, T10B, T10C



### T10A

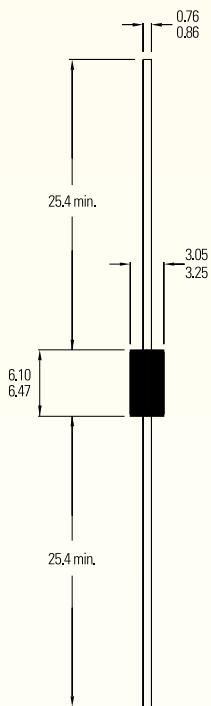

All dimensions in mm

### T10B

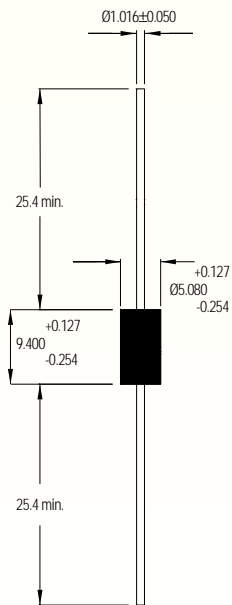

All dimensions in mm

### Electrical Characteristics

DEVICE TYPE	V <sub>RM</sub> (V)	I <sub>RM</sub> @ V <sub>RM</sub> (μA)	V <sub>BR</sub> MIN. @ 1 mA (V)	V <sub>BO</sub> MAX. (V)	V <sub>T</sub> TYP @ 1A (V)	I <sub>BO</sub> TYP (mA)	I <sub>H</sub> MIN. (mA)
T10 A, B, C 080	70	1	80	120	2	50	B or E
T10 A, B, C 110	100	1	110	135	2	50	B or E
T10 A, B, C 140	120	1	140	170	2	50	B or E
T10 A, B, C 180	170	1	180	210	4	50	B or E
T10 A, B, C 220	200	1	215	265	4	50	B or E
T10 A, B, C 270	240	1	270	360	4	50	B or E

### T10C

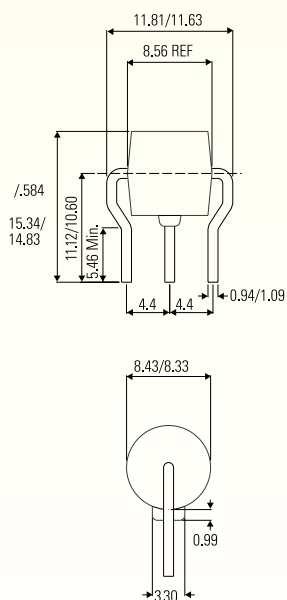

All dimensions in mm

### MINIMUM HOLDING CURRENTS I<sub>H</sub> MIN.

Suffix	I <sub>H</sub>
B	120
E	180

### FEATURES

- High current diverting capability, 150 A, 8 X 20 μs
- Low capacitance, less than 100 pF

Peak Pulse	T10A	T10B	T10C
8/20μs	150	250	250
10/700 1-5kv	37.5	125	125
10/1000μs	50	100	100

### T10

Package  
 A = DO15  
 B = DO-201  
 C = GDT outline

Voltage

Holding current  
 B = 120 I<sub>H</sub> min.  
 E = 180 I<sub>H</sub> min.





 **SiBOD™ Series**

**Specify Crydom**

... for these industry-leading components and products:

- **Solid State Relays**
  - Printed Circuit Board Mount
  - Panel Mount
  - DIN Rail Mount
- **Power Cubes**
- **I/O Modules**
- **Transient Voltage Suppression Components**
  - TVS Diodes
  - Thyristor Suppression Devices
  - Gas Discharge Tubes (GDT)
  - Zeners/Studs
  - Hybrid Arrester Devices

**Ordering Information**

For recommended applications and more information contact:

Sales: 1-877-502-5500  
Technical support: 1-877-702-7700  
Corporate Headquarters: 1-858-715-7200  
Fax: 1-858-715-7280  
E-mail: sales@crydom.com  
Website: www.crydom.com  
FASTFAX Product Info: 1-888-267-9191

**About Crydom**

Over the years Crydom has become the supplier of choice for advanced, high-quality products like those featured here. It's the result of our teams of design and production engineers – material, production control, and quality assurance experts, and more – working seamlessly together to create, produce, and deliver superior components and products that satisfy the most demanding environmental and performance requirements. We focus on timely delivery and competitive pricing aimed at meeting your needs and helping you succeed in today's fast-paced, fast-changing global markets.



**Crydom**  
9525 Chesapeake Drive  
San Diego, CA 92123 USA



©1999 Crydom  
Specifications subject to change without notice.