

CSD20060D–Silicon Carbide Schottky Diode

ZERO RECOVERY® RECTIFIER

V_{RRM}	= 600 V
$I_{F(AVG)}$	= 20 A
Q_c	= 56 nC

Features

- 600-Volt Schottky Rectifier
- Zero Reverse Recovery Current
- Zero Forward Recovery Voltage
- High-Frequency Operation
- Temperature-Independent Switching Behavior
- Extremely Fast Switching
- Positive Temperature Coefficient on V_F

Benefits

- Replace Bipolar with Unipolar Rectifiers
- Essentially No Switching Losses
- Higher Efficiency
- Reduction of Heat Sink Requirements
- Parallel Devices Without Thermal Runaway

Applications

- Switch Mode Power Supplies
 - Typical PFC P_{out} : 2000W-4000W
- Motor Drives
 - Typical Power : 5HP-10HP

Package

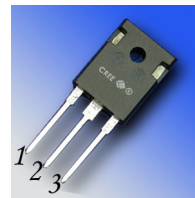

TO-247-3

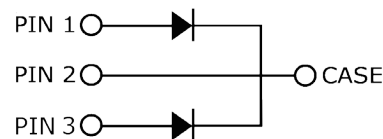

Part Number	Package	Marking
CSD20060D	TO-247-3	CSD20060

Maximum Ratings

Symbol	Parameter	Value	Unit	Test Conditions	Note
V_{RRM}	Repetitive Peak Reverse Voltage	600	V		
V_{RSM}	Surge Peak Reverse Voltage	600	V		
V_{DC}	DC Blocking Voltage	600	V		
$I_{F(AVG)}$	Average Forward Current (Per Leg/Device)	10/20 16.5/33	A	$T_c=150^\circ\text{C}$ $T_c=125^\circ\text{C}$	
$I_{F(Peak)}$	Peak Forward Current	25/50	A	$T_c=125^\circ\text{C}$, $T_{REP}<1\text{ mS}$, Duty=0.5	
I_{FRM}	Repetitive Peak Forward Surge Current (Per Leg/Device)	43/86 29/58	A	$T_c=25^\circ\text{C}$, $t_p=10\text{ ms}$, Half Sine Wave $T_c=125^\circ\text{C}$, $t_p=10\text{ ms}$, Half Sine Wave	
I_{FSM}	Non-Repetitive Peak Forward Surge Current (Per Leg)	77	A	$T_c=25^\circ\text{C}$, $t_p=1.5\text{ ms}$, Half Sine Wave	
I_{FSM}	Non-Repetitive Peak Forward Surge Current (Per Leg/Device)	250/500	A	$T_c=25^\circ\text{C}$, $t_p=10\ \mu\text{s}$, Pulse	
P_{tot}	Power Dissipation (Per Leg)	138 46	W	$T_c=25^\circ\text{C}$ $T_c=125^\circ\text{C}$	
T_J, T_{stg}	Operating Junction and Storage Temperature	-55 to +175	$^\circ\text{C}$		
	TO-247 Mounting Torque	1 8.8	Nm lbf-in	M3 Screw 6-32 Screw	

Electrical Characteristics (Per Leg)

Symbol	Parameter	Typ.	Max.	Unit	Test Conditions	Note
V_F	Forward Voltage	1.5 2.0	1.8 2.4	V	$I_F = 10\text{ A}$ $T_J = 25^\circ\text{C}$ $I_F = 10\text{ A}$ $T_J = 175^\circ\text{C}$	
I_R	Reverse Current	50 100	200 1000	μA	$V_R = 600\text{ V}$ $T_J = 25^\circ\text{C}$ $V_R = 600\text{ V}$ $T_J = 175^\circ\text{C}$	
Q_C	Total Capacitive Charge	28		nC	$V_R = 600\text{ V}$, $I_F = 10\text{ A}$ $di/dt = 500\text{ A}/\mu\text{s}$ $T_J = 25^\circ\text{C}$	
C	Total Capacitance	550 65 50		pF	$V_R = 0\text{ V}$, $T_J = 25^\circ\text{C}$, $f = 1\text{ MHz}$ $V_R = 200\text{ V}$, $T_J = 25^\circ\text{C}$, $f = 1\text{ MHz}$ $V_R = 400\text{ V}$, $T_J = 25^\circ\text{C}$, $f = 1\text{ MHz}$	

Note:

1. This is a majority carrier diode, so there is no reverse recovery charge.

Thermal Characteristics

Symbol	Parameter	Typ.	Unit
$R_{\theta JC}$	Thermal Resistance from Junction to Case	1.08** 0.54*	$^\circ\text{C}/\text{W}$

** Per Leg, * Both Legs

Typical Performance (Per Leg)

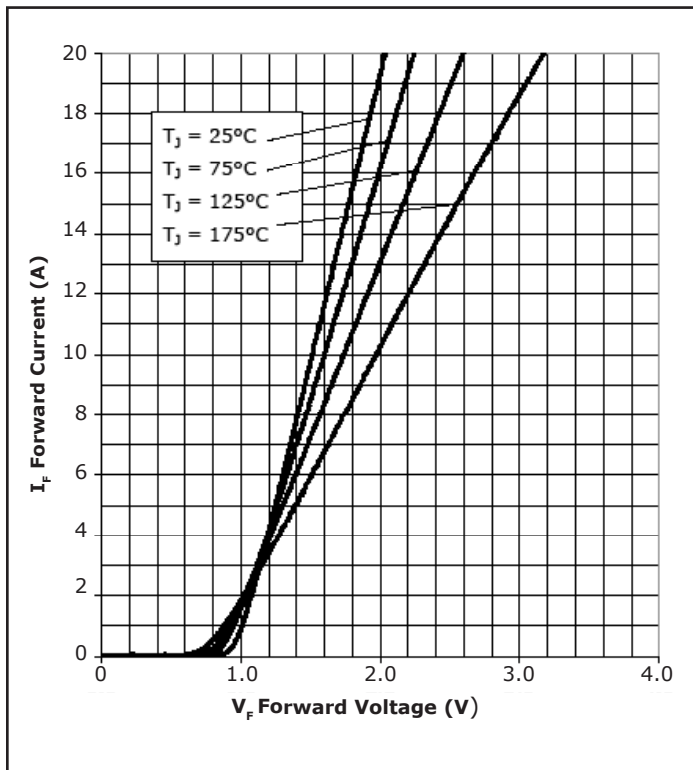

Figure 1. Forward Characteristics

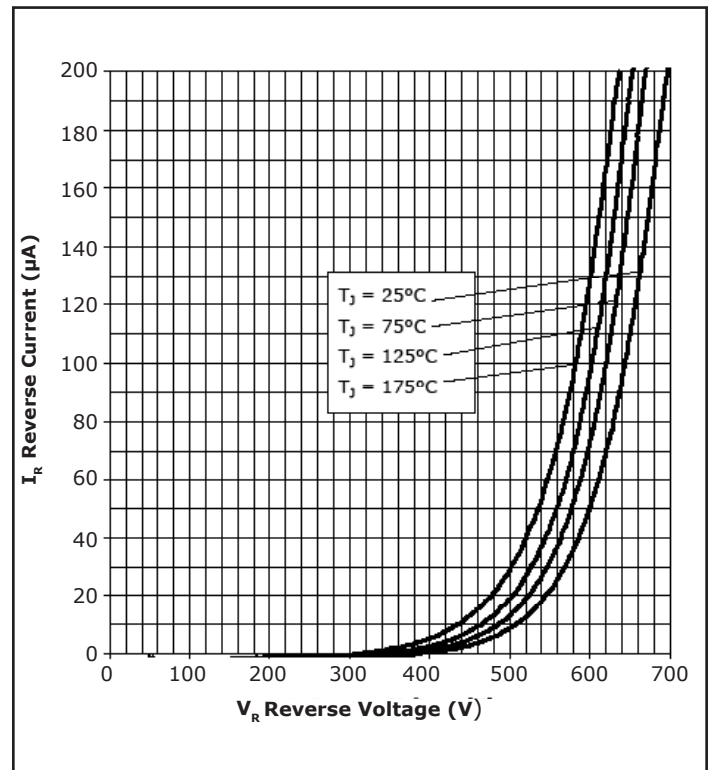

Figure 2. Reverse Characteristics

Typical Performance (Per Leg)

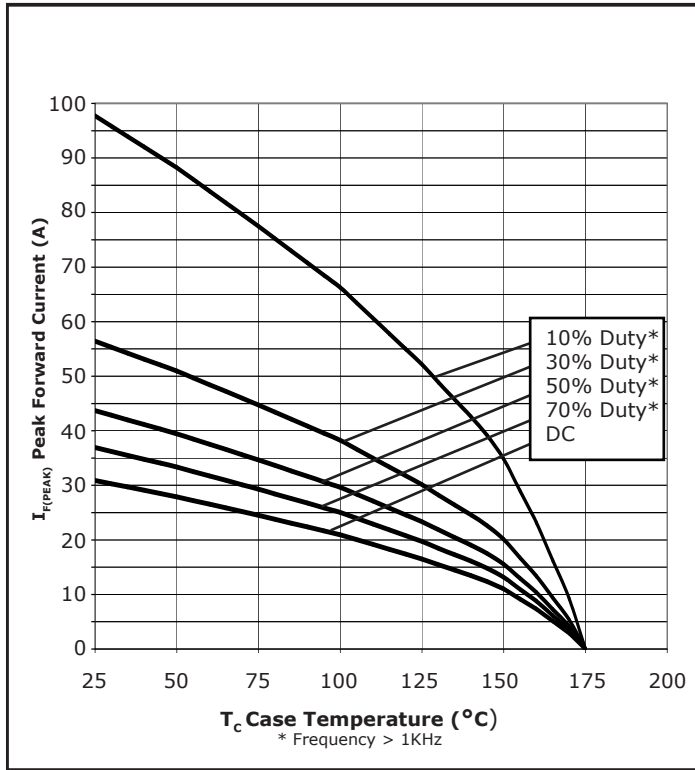

Figure 3. Current Derating

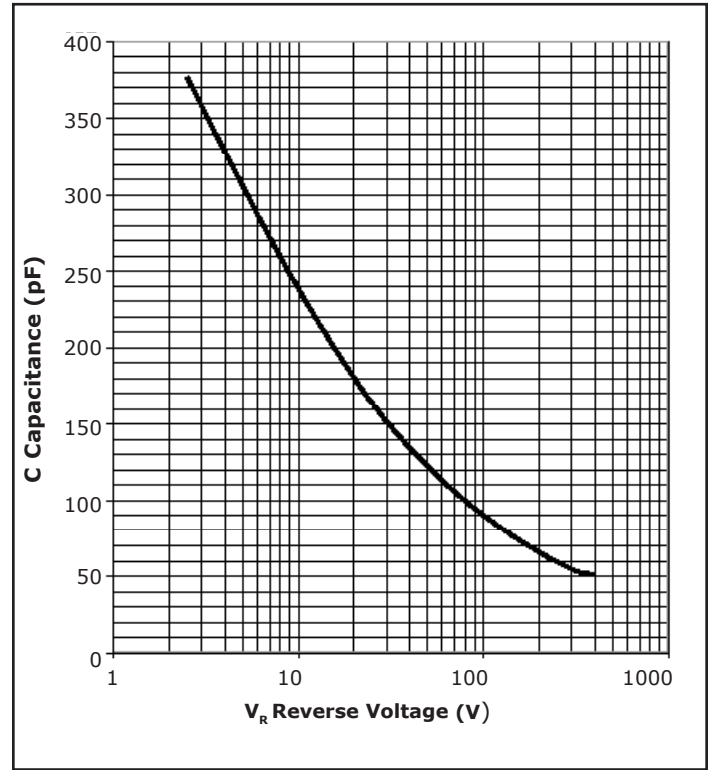

Figure 4. Capacitance vs. Reverse Voltage

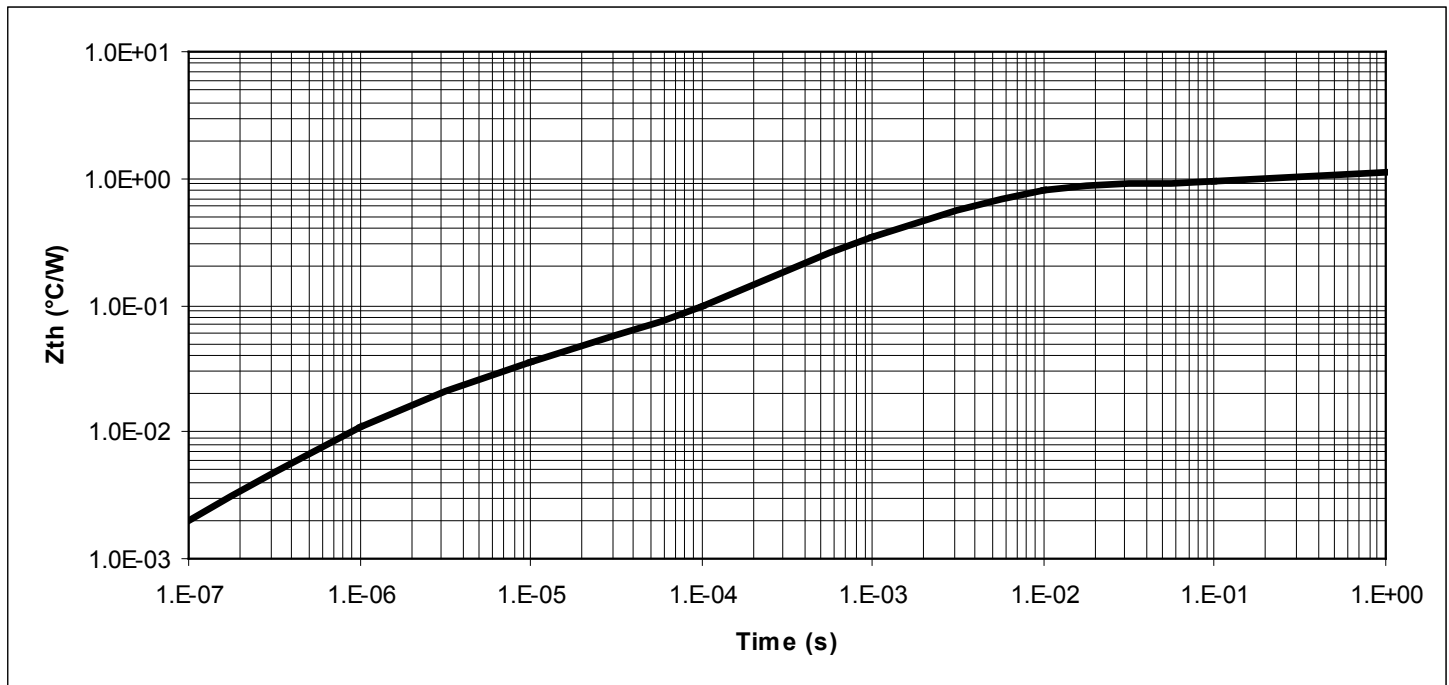

Figure 5. Transient Thermal Impedance

Typical Performance (Per Leg)

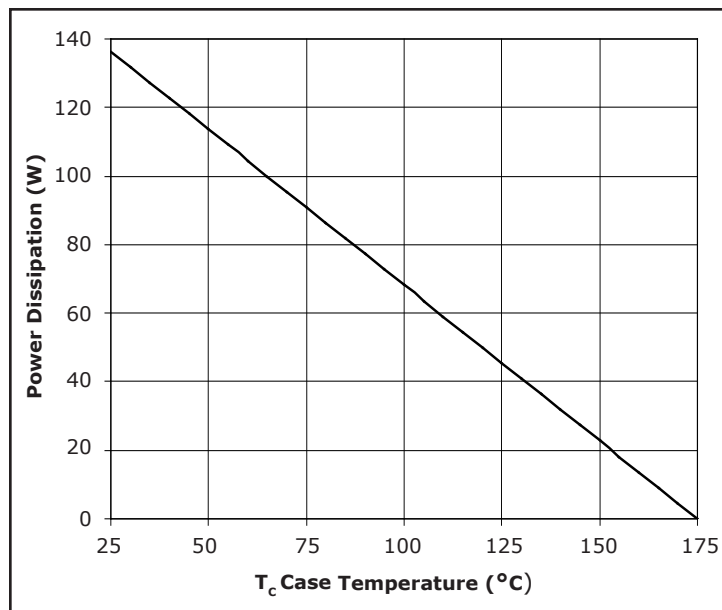
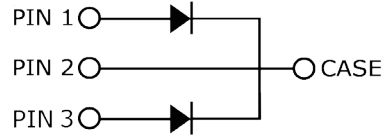
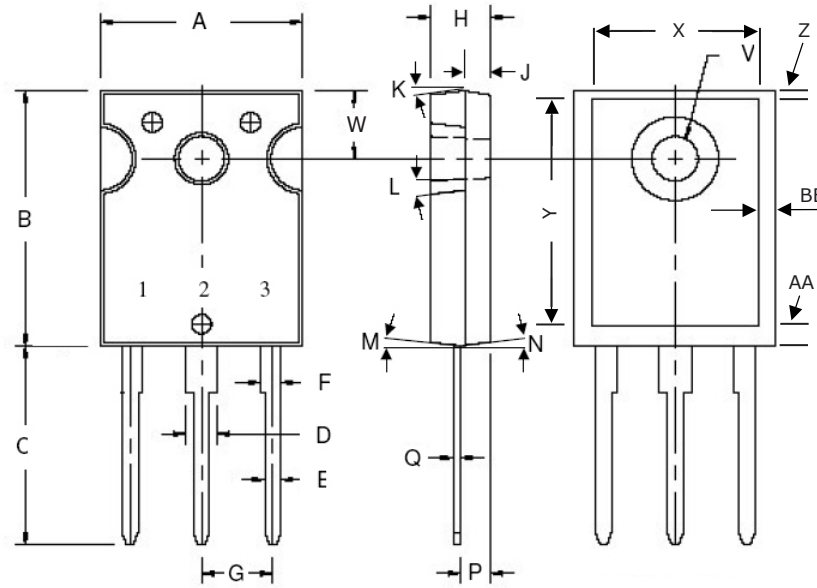

Figure 6. Power Derating

Package Dimensions

Package TO-247-3



POS	Inches		Millimeters	
	Min	Max	Min	Max
A	.605	.631	15.367	16.027
B	.800	.830	20.320	21.082
C	.789	.800	20.05	20.31
D	.095	.126	2.413	3.200
E	.046	.052	1.168	1.321
F	.060	.084	1.524	2.134
G	.215 TYP		.215 TYP	
H	.180	.203	4.572	5.156
J	.078	.081	1.982	2.057
K	6°	21°	6°	21°
L	4°	6°	4°	6°
M	2°	4°	2°	4°
N	2°	4°	2°	4°
P	.090	.097	2.286	2.464
Q	.020	.030	.508	.762
R	9°	11°	9°	11°
S	9°	11°	9°	11°
T	2°	8°	2°	8°
U	2°	8°	2°	8°
V	.138	.144	3.505	3.658
W	.210	.220	5.334	5.588
X	.502	.557	12.751	14.148
Y	.637	.695	16.180	17.653
Z	.040	.052	1.016	1.321
AA	.032	.046	.813	1.168
BB	.110	.140	2.794	3.556

Recommended Solder Pad Layout

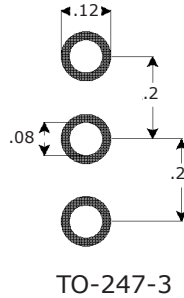

Part Number	Package	Marking
CSD20060D	TO-247-3	CSD20060

Diode Model

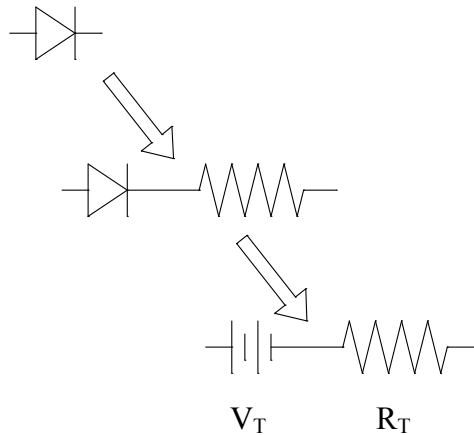

$$V_{fT} = V_T + I_f \cdot R_T$$

$$V_T = 0.92 + (T_j * -1.35 * 10^{-3})$$

$$R_T = 0.052 + (T_j * 0.29 * 10^{-3})$$

Note: T_j = Diode Junction Temperature In Degrees Celcius

"The levels of environmentally sensitive, persistent biologically toxic (PBT), persistent organic pollutants (POP), or otherwise restricted materials in this product are below the maximum concentration values (also referred to as the threshold limits) permitted for such substances, or are used in an exempted application, in accordance with EU Directive 2002/95/EC on the restriction of the use of certain hazardous substances in electrical and electronic equipment (RoHS), as amended through April 21, 2006. This part number was released previously with Sn/Pb solder plating as a standard industry finish. For more information please contact power_sales@cree.com"

This product has not been designed or tested for use in, and is not intended for use in, applications implanted into the human body nor in applications in which failure of the product could lead to death, personal injury or property damage, including but not limited to equipment used in the operation of nuclear facilities, life-support machines, cardiac defibrillators or similar emergency medical equipment, aircraft navigation or communication or control systems, air traffic control systems, or weapons systems.

Copyright © 2006-2009 Cree, Inc. All rights reserved. The information in this document is subject to change without notice. Cree, the Cree logo, and Zero Recovery are registered trademarks of Cree, Inc.

Cree, Inc.
4600 Silicon Drive
Durham, NC 27703
USA Tel: +1.919.313.5300
Fax: +1.919.313.5451
www.cree.com/power