

NUMERIC/ALPHANUMERIC DISPLAY

GENERAL INFORMATION

Part Number System

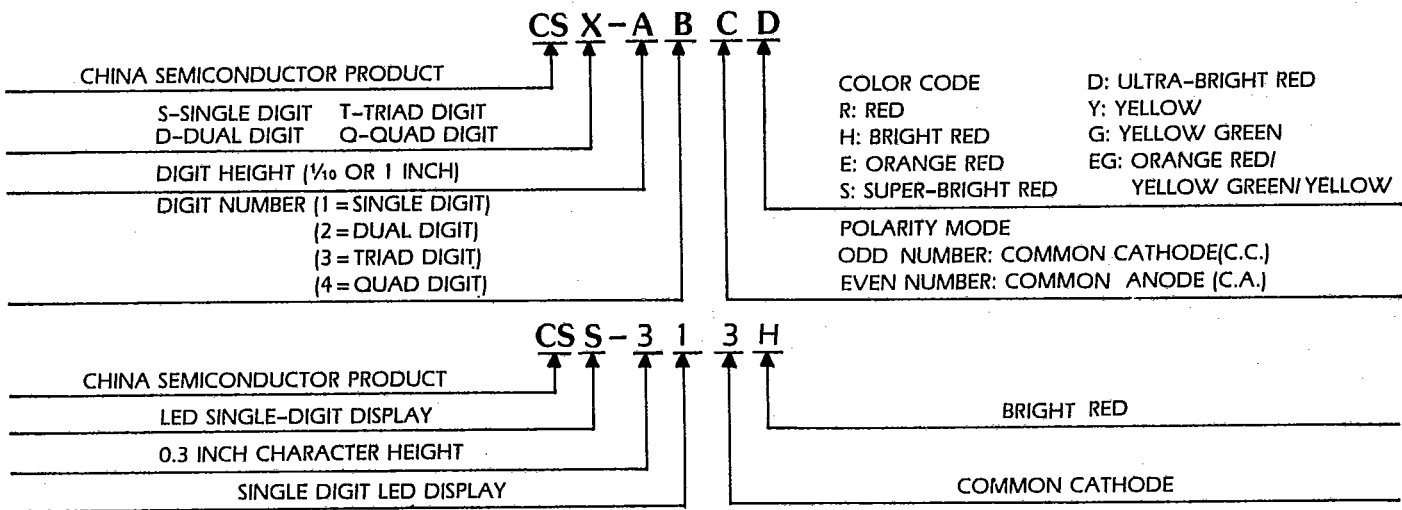













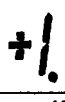











Electro-Optical Characteristics (Ta = 25°C)







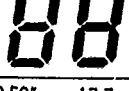
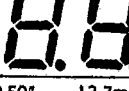

| COLOR | Peak Emission Wavelength λ_p (nm) | Dice Material | Forward Voltage V_F (V) | | Luminous Intensity I_v (ucd) | Test Condition |
|------------------|---|------------------|---------------------------|-----|--------------------------------|----------------|
| | | | TYP | MAX | | |
| RED | 655 | GaAsP/GaAs | 1.7 | 2.0 | 1,000 | $I_F = 20$ mA |
| BRIGHT RED | 695 | GaP/GaP | 2.0 | 2.8 | 1,400 | $I_F = 20$ mA |
| ORANGE RED | 635 | GaAsP/GaP | 2.1 | 2.8 | 4,000 | $I_F = 20$ mA |
| SUPER-BRIGHT RED | 660 | GaAlAs/GaAs (SH) | 1.8 | 2.5 | 6,000 | $I_F = 20$ mA |
| ULTRA-BRIGHT RED | 660 | GaAlAs/GaAs (DH) | 1.8 | 2.5 | 10,000 | $I_F = 20$ mA |
| YELLOW | 590 | GaAsP/GaP | 2.1 | 2.8 | 4,000 | $I_F = 20$ mA |
| YELLOW GREEN | 570 | GaP/GaP | 2.2 | 2.8 | 4,000 | $I_F = 20$ mA |

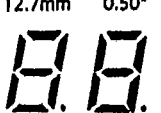
| DIGIT HEIGHT | DIGIT/ DRIVE MODE | CSC PART NUMBER: CSS-, CSD-, CST-, CSQ- | | | | | | | MODE |
|----------------|-------------------|---|--------------|--------------|------------------|------------------|--------------|--------------|--------------|
| | | RED | BRIGHT RED | ORANGE RED | SUPER-BRIGHT RED | ULTRA-BRIGHT RED | YELLOW GREEN | YELLOW | |
| 0.30" 7.6mm | 1 N/A | 311R | 311H | 311E | 311S | 311D | 311G | 311Y | N/A |
| 0.30" 7.6mm | 1 N/A | 312R 313R | 312H 313H | 312E 313E | 312S 313S | 312D 313D | 312G 313G | 312Y 313Y | C.A. C.C. |
| 0.36" 9.1mm | 1 N/A | 316R 317R | 316H 317H | 316E 317E | 316S 317S | 316D 317D | 316G 317G | 316Y 317Y | C.A. C.C. |

CSC PART NUMBER: CSS-, CSD-, CST-, CSQ-

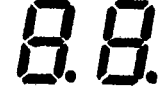
| DIGIT HEIGHT | DIGIT/ DRIVE MODE | CSC PART NUMBER: CSS-, CSD-, CST-, CSQ- | | | | | | | MODE |
|---|-------------------|---|--------------|--------------|------------------|------------------|--------------|--------------|--------------|
| | | RED | BRIGHT RED | ORANGE RED | SUPER-BRIGHT RED | ULTRA-BRIGHT RED | YELLOW GREEN | YELLOW | |
| 0.36" 9.2mm  | 1 N/A | 318R 319R | 318H 319H | 318E 319E | 318S 319S | 318D 319D | 318G 319G | 318Y 319Y | C.A. C.C. |
| 0.40" 10.2mm  | 1 N/A | 410R | 410H | 410E | 410S | 410D | 410G | 410Y | N/A |
| 0.40" 10.2mm  | 1 N/A | 414R 415R | 414H 415H | 414E 415E | 414S 415S | 414D 415D | 414G 415G | 414Y 415Y | C.A. C.C. |
| 0.43" 11.0mm  | 1 N/A | 401R | 401H | 401E | 401S | 401D | 401G | 401Y | N/A |
| 0.43" 11.0mm  | 1 N/A | 416R 417R | 416H 417H | 416E 417E | 416S 417S | 416D 417D | 416G 417G | 416Y 417Y | C.A. C.C. |
| 0.50" 12.7mm  | 1 N/A | 510R 511R | 510H 511H | 510E 511E | 510S 511S | 510D 511D | 510G 511G | 510Y 511Y | C.A. C.C. |
| 0.50" 12.7mm  | 1 N/A | 512R 513R | 512H 513H | 512E 513E | 512S 513S | 512D 513D | 512G 513G | 512Y 513Y | C.A. C.C. |
| 0.52" 13.2mm  | 1 N/A | 516R 517R | 516H 517H | 516E 517E | 516S 517S | 516D 517D | 516G 517G | 516Y 517Y | C.A. C.C. |
| 0.52" 13.2mm  | 1 N/A | 518R 519R | 518H 519H | 518E 519E | 518S 519S | 518D 519D | 518G 519G | 518Y 519Y | C.A. C.C. |
| 0.56" 14.2mm  | 1 N/A | 514R 515R | 514H 515H | 514E 515E | 514S 515S | 514D 515D | 514G 515G | 514Y 515Y | C.A. C.C. |
| 0.60" 15.2mm  | 1 N/A | N/A N/A | 612H 613H | 612E 613E | 612S 613S | 612D 613D | 612G 613G | 612Y 613Y | C.A. C.C. |
| 0.63mm 16.0mm  | 1 N/A | 614R 615R | 614H 615H | 614E 615E | 614S 615S | 614D 615D | 614G 615G | 614Y 615Y | C.A. C.C. |
| 0.80" 20.3mm  | 1 N/A | N/A N/A | 815H 816H | 815E 816E | 815S 816S | 815D 816D | 815G 816G | 815Y 816Y | C.C. C.A. |

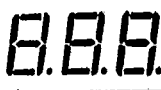
| DIGIT HEIGHT | DIGIT/ DRIVE MODE | CSC PART NUMBER: CSS-, CSD-, CST-, CSO- | | | | | | | MODE |
|---|-------------------|---|----------------|----------------|------------------|------------------|----------------|----------------|--------------|
| | | RED | BRIGHT RED | ORANGE RED | SUPER-BRIGHT RED | ULTRA-BRIGHT RED | YELLOW GREEN | YELLOW | |
| 0.80" 20.3mm  | 1 N/A | N/A N/A | 817H 818H | 817E 818E | 817S 818S | 817D 818D | 817G 818G | 817Y 818Y | C.C. C.A. |
| 1.02" 26.0mm  | 1 N/A | 1012R 1013R | 1012H 1013H | 1012E 1013E | 1012S 1013S | 1012D 1013D | 1012G 1013G | 1012Y 1013Y | C.A. C.C. |
| 1.77" 45.0mm  | 1 N/A | N/A N/A | N/A N/A | 1814E 1815E | 1814S 1815S | 1814D 1815D | 1814G 1815G | 1814Y 1815Y | C.A. C.C. |
| 2.00" 50.8mm  | 1 N/A | N/A N/A | N/A N/A | 2012E 2013E | 2012S 2013S | 2012D 2013D | 2012G 2013G | 2012Y 2013Y | C.A. C.C. |
| 2.24" 57.0mm  | 1 N/A | N/A N/A | N/A N/A | 2314E 2315E | 2314S 2315S | 2314D 2315D | 2314G 2315G | 2314Y 2315Y | C.A. C.C. |
| 4.00" 101.6mm  | 1 N/A | N/A N/A | N/A N/A | 4012E 4013E | 4012S 4013S | 4012D 4013D | 4012G 4013G | 4012Y 4013Y | C.A. C.C. |
| 0.30" 7.6mm  | 2 DUPLEX | 322R 323R | 322H 323H | 322E 323E | 322S 323S | 322D 323D | 322G 323G | 322Y 323Y | C.A. C.C. |
| 0.30" 7.6mm  | 2 DIRECT | 326R 327R | 326H 327H | 326E 327E | 326S 327S | 326D 327D | 326G 327G | 326Y 327Y | C.A. C.C. |
| 0.30" 7.6mm  | 2 DIRECT | 328R 329R | 328H 329H | 328E 329E | 328S 329S | 328D 329D | 328G 329G | 328Y 329Y | C.A. C.C. |
| 0.40" 10.0mm  | 2 DIRECT | 422R 423R | 422H 423H | 422E 423E | 422S 423S | 422D 423D | 422G 423G | 422Y 423Y | C.A. C.C. |
| 0.40" 10.1mm  | 2 DIRECT | 424R 425R | 424H 425H | 424E 425E | 424S 425S | 424D 425D | 424G 425G | 424Y 425Y | C.A. C.C. |
| 0.50" 12.7mm  | 2 DIRECT | 520R 521R | 520H 521H | 520E 521E | 520S 521S | 520D 521D | 520G 521G | 520Y 521Y | C.A. C.C. |
| 0.50" 12.7mm  | 2 DUPLEX | 522R 523R | 522H 523H | 522E 523E | 522S 523S | 522D 523D | 522G 523G | 522Y 523Y | C.A. C.C. |

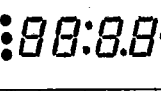
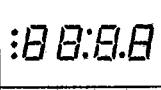
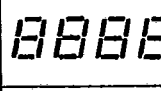
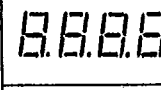
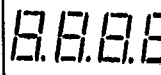
| DIGIT HEIGHT | DIGIT/ DRIVE MODE | CSC PART NUMBER: CSS-, CSD-, CST-, CSQ- | | | | | | | MODE |
|--|-------------------------|---|----------------|----------------|-------------------------|-------------------------|-----------------|----------------|--------------|
| | | RED | BRIGHT RED | ORANGE RED | SUPER- BRIGHT RED | ULTRA- BRIGHT RED | YELLOW GREEN | YELLOW | |
| 12.7mm 0.50"  | 2 DIRECT | 528R 529R | 528H 529H | 528E 529E | 528S 529S | 528D 529D | 528G 529G | 528Y 529Y | C.A. C.C. |
| 13.8mm 0.54"  | 2 DUPLEX | 5422R 5423R | 5422H 5423H | 5422E 5423E | 5422S 5423S | 5422D 5423D | 5422G 5423G | 5422Y 5423Y | C.A. C.C. |
| 14.2mm 0.56"  | 2 DIRECT | 524R 525R | 524H 525H | 524E 525E | 524S 525S | 524D 525D | 524G 525G | 524Y 525Y | C.A. C.C. |
| 14.2mm 0.56"  | 2 DIRECT | 526R 527R | 526H 527H | 526E 527E | 526S 527S | 526D 527D | 526G 527G | 526Y 527Y | C.A. C.C. |
| 14.2mm 0.56"  | 2 DIRECT | 5622R 5623R | 5622H 5623H | 5622E 5623E | 5622S 5623S | 5622D 5623D | 5622G 5623G | 5622Y 5623Y | C.A. C.C. |
| 20.3mm 0.80"  | 2 DIRECT | N/A N/A | 822H 823H | 822E 823E | 822S 823S | 822D 823D | 822G 823G | 822Y 823Y | C.A. C.C. |
| 14.2mm 0.56"  | 3 MPX | 532R 533R | 532H 533H | 532E 533E | 532S 533S | 532D 533D | 532G 533G | 532Y 533Y | C.A. C.C. |
| 14.2mm 0.56"  | 3 DIRECT | 534R 535R | 534H 535H | 534E 535E | 534S 535S | 534D 535D | 534G 535G | 534Y 535Y | C.A. C.C. |
| 6.2mm 0.25"  | 4 DIRECT | 253R 254R | 253H 254H | 253E 254E | 253S 254S | 253D 254D | 253G 254G | 253Y 254Y | C.C. C.A. |
| 6.2mm 0.25"  | 4 MPX | 255R 256R | 255H 256H | 255E 256E | 255S 256S | 255D 256D | 255G 256G | 255Y 256Y | C.C. C.A. |
| 7.0mm 0.27"  | 4 MPX | N/A 247R | N/A 247H | N/A 247E | N/A 247S | N/A 247D | N/A 247G | N/A 247Y | N/A C.C. |
| 14.2mm 0.56"  | 4 MPX | 541R 542R | 541H 542H | 541E 542E | 541S 542S | 541D 542D | 541G 542G | 541Y 542Y | C.C. C.A. |
| 14.2mm 0.56"  | 4 DIRECT | 543R 544R | 543H 544H | 543E 544E | 543S 544S | 543D 544D | 543G 544G | 543Y 544Y | C.C. C.A. |